



July 26, 2018

Mr. James R. Beyer
Regional Licensing and Compliance Manager
Eastern Maine Regional Office
Department of Environmental Protection
106 Hogan Road
Bangor, ME 04401

RE: NECEC Overhead Crossing of the Kennebec River

Dear Jim:

This letter responds with the additional information regarding alternatives to the preferred overhead crossing of the Kennebec River (Preferred Alternative) requested in your May 7, 2018 letter. We intend for this information to supplement the alternatives analysis and supporting information contained in our September 2017 Site Location of Development Act (Site Law) and Natural Resources Protection Act (NRPA) application materials. This information further demonstrates that the Preferred Alternative is reasonable and that there is no reasonable alternative to this proposed overhead crossing.

Applicable Standards

Pursuant to the standards set forth in Maine statute and DEP regulations, and summarized briefly below, the Preferred Alternative will not unreasonably interfere with existing scenic and aesthetic uses, or natural resources, and no reasonable alternative exists. Accordingly, it is the reasonable alternative.

1. No Unreasonable Adverse Impacts

The NRPA, 38 M.R.S. § 480-D(1), provides that the applicant must demonstrate that “[t]he activity will not unreasonably interfere with existing scenic, aesthetic, recreational or navigational uses.” In making its determination as to whether adverse impacts to existing scenic and aesthetic uses are unreasonable, the DEP considers whether the applicant’s design is visually compatible with its surroundings, incorporating environmentally sensitive design principles and components according to planning and siting, design, and offset strategies. DEP Reg. 315.8. The DEP bases its determination of impact on the following visual elements of the landscape: landscape compatibility, scale contrast, and spatial dominance. DEP Reg. 315.9. As explained in the NRPA Application, and as supplemented below, the Preferred Alternative is sited and designed such that it will have no unreasonable adverse impact to, nor will it unreasonably interfere with, existing scenic, aesthetic, recreational, or navigational uses.

The Site Law, 38 M.R.S. § 484(3), further requires that the DEP approve a proposal where “[t]he developer has made adequate provision for fitting the development harmoniously into the existing natural environment and that the development will not adversely affect existing uses, scenic character, air quality, water quality or other natural resources in the municipality or in neighboring municipalities.” In making this determination, the DEP considers all relevant evidence, such as evidence that the design of the proposed development takes into account the scenic character of the surrounding area, that a development which is not in keeping with the surrounding scenic character will be located, designed, and landscaped to minimize its visual impact to the fullest extent possible, and that structures will be designed and landscaped to minimize their visual impact on the surrounding area. DEP Reg. 375.14(B). As explained in the NRPA Application and the Site Law Application, and as supplemented below, CMP has made adequate provision to fit the Preferred Alternative harmoniously into the existing natural environment, and has sited, designed, and landscaped (e.g., CMP proposed the retain existing vegetation in proximity to) this overhead crossing such that it will not adversely affect existing uses, scenic character, air quality, water quality, or other natural resources.

2. No Reasonable Alternative

The NRPA further governs proposed activities that cross any outstanding river segment as identified in section 480-P, and provides that “the applicant shall demonstrate that no reasonable alternative exists which would have less adverse effect upon the natural and recreational features of the river segment.” 38 M.R.S. § 480-D(8). As explained in the NRPA Application and the Site Law Application, and as supplemented below, no reasonable alternative exists to the Preferred Alternative that would have less adverse effect upon the natural and recreational features of the affected river segment.

The Preferred Alternative also is the least environmentally damaging practicable alternative pursuant to U.S. Army Corps of Engineers (USACE) review guidelines. 40 CFR § 230.10(a). *See also* 13 U.S.C. § 1344; CWA § 404(b)(1). Under these guidelines, practicable alternatives include, but are not limited to, activities that do not involve a discharge of dredged or fill material into the waters of the United States, and discharges of dredged or fill material at other locations in waters of the United States. 40 CFR § 230.10(a)(1). An alternative is practicable only if it is available and capable of being done after taking into consideration cost, existing technology, and logistics in light of overall project purposes. 40 CFR § 230.10(a)(2). Pursuant to these guidelines, the alternatives discussed below are not practicable.

3. LUPC Special Exception Criteria

Finally, your letter also notes that because the Preferred Alternative is within the Recreation Protection (P-RR) subdistrict it must meet the LUPC’s special exception criteria. *See* 38 M.R.S. § 489-A-1(2). Utility facilities are “allowed” uses in the P-RR subdistrict, by special exception, provided that: (a) there is no alternative site which is both suitable to the proposed use and reasonably available to the applicant;¹ (b)

¹ In making its determination as to whether an alternative is “reasonably available,” the LUPC must consider the reasonableness of utilizing that alternative and not merely what is “available.” *See, e.g.,* Site Law Certification SLC

the use can be buffered from those other uses and resources within the subdistrict with which it is incompatible; and (c) such other conditions are met that the LUPC may reasonably impose. LUPC Reg. 10.23(l)(3)(d)(8). *See also* LUPC Reg. 10.23(l)(3)(f) (“All uses not expressly allowed, with or without a permit or by special exception, shall be prohibited in P-RR subdistricts.”).

Because the DEP’s Site Law and NRPA review of the Project will consider all applicable standards that the LUPC would otherwise consider in granting a special exception,² no special exception review is required by LUPC.³ As demonstrated in the Site Law and NRPA applications, as well as below, there is no alternative site that is both suitable to the proposed use and reasonably available to CMP, and the Preferred Alternative can and will be adequately buffered from other uses and resources within the subdistrict. *See* Site Law Application Section 25.

The Preferred Alternative will not have unreasonable adverse impacts.

1. The Preferred Alternative location is not unique and the associated recreational experience is not pristine.

As an initial matter, and although the location of the Preferred Alternative overhead crossing of the Kennebec River has on occasion been referred to (including by CMP) as being at the “Gorge,” the location of the Preferred Alternative is not actually part of the “Gorge” itself. This is relevant because the proposed overhead crossing of the Kennebec River is at a point that is not as unique as the Gorge itself, which must be considered when evaluating the reasonableness of the Preferred Alternative.

According to American Whitewater, for example, the Gorge extends for 3.5 miles from Harris Station Dam to Carry Brook.⁴ Downstream of the Class III and IV rapids that run through the Gorge, after Carry

5 Certification at ¶10 (July 9, 2014), available at: http://www.maine.gov/dacf/lupc/projects/site_law_certification/slc5.pdf (in which the LUPC considered the reasonableness of alternatives in terms of their relative benefits and found that there is no alternative site which is both suitable to the proposed use and reasonably available to the applicant precisely because none of the alternatives provided any benefit above the chosen site); Amendment A to Utility Line Permit ULP 178 at ¶¶12, 15 and Conclusion ¶2 (Apr. 1, 2015) available at: <http://www.maine.gov/dacf/lupc/signedpermits/ulp178a.pdf> (considering the reasonableness of alternatives in terms of the cost, visual impact, and safety relative to the preferred alternative).

² DEP’s review of the Project will consider alternative sites under NRPA. *See* 06-096 CMR 310.5, 06-096 CMR 310.9(A), and 06-096 CMR 335.3(C). Both the Site Law and NRPA applications require a narrative and drawing of proposed buffers, and the Site Law further requires this in 06-096 CMR 375.9(D). *See* Attachment I (June 2017 email correspondence with LUPC).

³ Pursuant to 38 M.R.S. § 489-A-1, the DEP reviews development within the unorganized and deorganized areas of Maine, and shall approve a development proposal under this section if it is an allowed use within the subdistrict or subdistricts in which it is to be located. 38 M.R.S. § 489-A-1(2)(A). The certification made by the LUPC concerns only those land use standards that are not considered in the DEP’s review. 38 M.R.S. § 489-A-1(2)(D).

⁴ *See* <https://www.americanwhitewater.org/content/River/detail/id/438>.

Brook, “the river becomes more sluggish the further downstream you go.”⁵ The Preferred Alternative crosses the Kennebec River about three miles downstream of the last major Class III and IV rapids (Black Brook Rapids). The three miles between Black Brook Rapids and the Project’s proposed overhead crossing location include occasional Class I or II rapids. At the Preferred Alternative location the river is generally flat water, and is not particularly valued by recreational users. CMP sited the Project at this flat water location to have the least impact on existing scenic and aesthetic uses.

The fact that the location of the proposed crossing is within the “outstanding river segment” that includes the Gorge does not mean that it is as valuable as the Gorge itself. The Legislature provided multiple segments of the Kennebec River with the special protections afforded to outstanding river segments, and those other outstanding river segments have overhead transmission line crossings. These include the 58.6 miles of the Kennebec River from Bay Point in Georgetown to its confluence with the Sebasticook River in Winslow (12 M.R.S. § 403(7), so designated in 2007), which segment includes three 345 kV transmission line crossings and many 115 kV and 34.5kV transmission line crossings. Also designated an outstanding river segment are the 32 miles of the Kennebec River from the Route 148 bridge in Madison to the Caratunk and The Forks Plantation town line (excluding the western shore in Concord Township, Pleasant Ridge Plantation, and Carrying Place Township, and excluding Wyman Lake) (38 M.R.S. § 480-P(8), so designated in 1987), which includes two 115 kV transmission line crossings and one 34.5 kV transmission line crossing.

The following transmission line crossings of the Kennebec River were constructed *prior to* designation of these segments as outstanding river segments:

- Section 207 (1947; 115 kV; Bath to Woolwich at Chops Point)
- Section 77 (1993; 34.5 kV; Bath to Woolwich at Chops Point)
- Section 375 (1970; 345 kV; Bowdoinham to Woolwich at Brown’s Point)
- Section 377 (1969; 345 kV; Bowdoinham to Woolwich at Brown’s Point)
- Section 19 (1962; 34.5 kV; Farmingdale to Chelsea at Brown’s Crossing)
- Section 13 (circa 1920; 34.5 kV; Waterville to Winslow)
- Section 81 (1953; 115 kV; Bowdoinham to Woolwich at Brown’s Point)
- Section 60 (original line circa 1923, rebuilt 1995; 115 kV; Farmingdale to Chelsea at Brown’s Crossing)
- Section 38 (original line circa 1925, rebuilt 1978; 34.5 kV; Augusta)
- Section 39 (original line circa 1925, rebuilt 1972; 34.5 kV; Augusta)
- Section 272 (1978; 115 kV; Augusta)
- Section 44 (1959; 34.5; Anson to Madison)
- Section 63 (original line circa 1932, rebuilt 1960; 115 kV; Concord to Moscow)⁶

⁵ *Id.*

⁶ The Concord side of the Kennebec River in this area is not an outstanding river segment.

The following transmission line crossing of the Kennebec River was constructed or reconstructed *after* designation of these segments as outstanding river segments:

- Section 3025 (2011; 345 kV; Farmingdale to Chelsea at Brown's Crossing)

Accordingly, pre-existing transmission line crossings do not disqualify a river segment from designation as an outstanding river segment. Nor does a river segment's designation as "outstanding" make a new transmission line crossing of that river segment unpermissible. In other words, just because the location of the proposed crossing is within a designated "outstanding river segment," that does not render the entire river segment pristine.

To the contrary, the overhead crossing would not be out of character with this section of the river. The entire Kennebec River whitewater rafting experience is inherently commercial. From late spring through early fall, the view at the location of the proposed crossing is of dozens of bright colored rafts, kayaks, and small inflatables, all with occupants who often are boisterous. And, as recently noted by the Portland Press Herald, this section of the Kennebec River plainly is not a wild river. The river below Harris Dam is a working resource, controlled by a dam, and private and individual boaters rely on human-controlled releases of water in this river segment:

There's an irony about debating the wild nature of the upper Kennebec River. If the river wasn't held back, first for log drives and later for hydropower, summer whitewater rafting wouldn't exist.

That reality is clear at 10 a.m. on a recent weekday at Harris Station, when a warning siren blares and a loudspeaker repeats: "Water levels downstream are increasing. Exit water immediately."

Within minutes, the river flow increases, as dam operators turn up the spigot on Indian Pond.⁷

This commercial and recreational use of this section of the river arguably has more impact on any bucolic nature of the river than does the proposed overhead crossing.

Additionally, rafters using the Kennebec Gorge already are exposed to and aware of existing transmission lines adjacent to the parking and staging areas prior to rafting. The sole vehicular access route to Harris Dam follows an existing transmission line, as Indian Pond Road is adjacent and parallel to the existing 150' wide cleared transmission corridor (the total corridor is 225') for 5.5 miles. The road is on the east side of the corridor in most locations, and the entire width of the road right-of-way is cleared to the transmission line corridor such that the transmission line corridor appears wider than

⁷ Tux Turkel, *Transmission lines over Kennebec Gorge? That may be a choke point for renewable energy advocates*, Portland Press Herald, June 24, 2018, at B1.

150'. These existing transmission lines are visible to rafters and other boaters while checking in, preparing to raft, and walking down the stairs next to the Harris Dam to put in to the water.

This existing human-caused visual impact at the Harris Dam put-in is significantly greater than the Preferred Alternative would be (see the discussion below), and affects rafters' and other boaters' aesthetic expectations on the river downstream.

Finally, we note that the Maine Department of Conservation (MDOC) has agreed that State ownership of the Gorge is not a basis to object to a proposed overhead transmission line at this location. See Attachment II, Agreement for Conveyance of Real Property – The Kennebec River Gorge Tract at ¶ 20 (Sept. 1, 2011) (in which “MDOC acknowledges that CMP is an electric utility company and is retaining ownership of a 300 foot wide corridor (a portion of the “retained lands”) north of Moxie Stream and Cold Stream for utility purposes including, but not limited to, the construction and operation and maintenance of overhead electric transmission lines, substations and appurtenant facilities. MDOC, for itself and its successors and assigns, covenants and agrees with CMP that this conveyance shall not be the basis for objecting to any future proposal by CMP to use the 300 foot wide corridor and appurtenant reserved access rights for such purposes.”).

2. The impact of the Preferred Alternative is minimal.

The visual impact of the Preferred Alternative is minimal. This is because CMP has located, designed, and planned for vegetation management of the Preferred Alternative specifically to minimize potential visual impacts to the fullest extent possible. As explained in the Site Law and NRPA applications, and as later revised, the design mitigates and buffers the overhead alternative to minimize both the duration and the extent of visibility of this aerial crossing. See Site Law Application Section 25.3.1.2; NRPA Application Section 2.4.1.2.

Note that the five pole option originally included in the Project's applications has been updated to a three pole option. This redesign was undertaken to increase and maximize the forested buffer on both sides of the riverbank and to remove two structures (3006-22, and 3006-23). The remaining two structures on the side-slopes of the Kennebec River (3006-21 and 3006-24) are screened from the line of sight of the users approaching the crossing point from upriver. See Attachment III, Response to the November 20, 2017, and December 12, 2017 MDEP Information Requests, at Responses 2 and 3 (Mar. 29, 2018). On the southeastern riverbank approximately 300 feet of mature forested buffer will be maintained, with trees within this buffer at an average height of 75 feet. On the northwestern riverbank approximately 550 feet of mature forested buffer will be maintained, with trees within this buffer also at an average height of 75 feet. At the centerline of the river, the conductor will be approximately 200 feet above the water level at maximum sag. *Id.* at Response 3. Advantages of the proposed three pole design compared to the five pole design include: fewer structures and associated ground disturbance; greater vertical clearance over the river and therefore reduced visibility from the water; greater vertical clearance over trees, allowing retention of trees over a larger area of forested buffer; and screened views of the transmission line structures and the cleared corridor from the perspective of river users. *Id.*

The Preferred Alternative also places transmission line structures outside of the P-RR subdistrict, and CMP proposes to utilize non-specular conductors at this crossing, to reduce the reflection of light by, and therefore the visibility of, the transmission line. See Site Law Application Section 25.3.1.2; NRPA Application Section 2.4.1.2; Attachment III at Response 2. Where terrain permits, CMP will allow mature trees to remain and to continue to grow to minimize views into the corridor from the river. *Id.*

Furthermore, photosimulations from multiple perspectives demonstrate that the Preferred Alternative would not unreasonably interfere with existing scenic and aesthetic uses, and therefore would not diminish the public enjoyment and appreciation of the qualities of this scenic resource. See Attachment IV, Response to the February 23, 2018 USACE Information Request, Attachment B: Kennebec River Gorge Photosimulations at Response 7 (Mar. 23, 2018). See also Attachment III, Response to the November 20, 2017, and December 12, 2017 MDEP Information Requests, Attachment A: Kennebec River Gorge Photosimulations, at Response 3 (Mar. 29, 2018). The transmission line at the Preferred Alternative location will be visible for only about 0.25 mile from the upstream side and 0.5 mile from the downstream side (assuming rafters turn around and look up after passing under the crossing, which would not be expected). With a typical current and raft/boat speed of about 6 miles per hour, the transmission line at the Preferred Alternative would be visible for only about 2.5 minutes from the upstream side and 5 minutes from the downstream side, again assuming rafters would turn around for this view. Due to the position, buffering, and limited duration of viewing, the overhead crossing in the proposed location will not diminish the recreational use or scenic character of the outstanding river segment located between the Forks and Indian Pond Dam. Accordingly, the two conductors and two shield wires that would cross the river at the Preferred Alternative location, which as described above is not particularly unique or wild, would not adversely affect existing uses of the Kennebec River.

Finally, CMP is proposing significant off-site mitigation specific to the Preferred Alternative, which we discussed at our May 31, 2018 meeting at DEP's Augusta office, and which would be lost if this alternative is not approved. While the Preferred Alternative will not have unreasonable impacts, and is the least environmentally damaging practicable alternative,⁸ this off-site mitigation is intended to alleviate any real or perceived adverse impacts of the Preferred Alternative. Specifically, and as set forth in the May 30, 2018 Memorandum of Understanding between CMP and Western Mountains & Rivers Corporation (WM&RC) (attached hereto as Attachment V) and the summary of that MOU that we

⁸ Because the Preferred Alternative is the least environmentally damaging practicable alternative, the USACE may consider the proposed mitigation and adopt such mitigation as a condition to the permit. See *Butte Environmental Council v. U.S. Army Corps of Engineers*, 620 F.3d 936, 946-947 (9th Cir. 2010) (rejecting plaintiff's contention that the USACE allowed the adoption of off-site mitigation measures to relieve the City of its responsibility to adopt the least environmentally damaging practicable alternative, and finding instead that while the USACE made compensatory mitigation a condition of the permit, "there is no indication that such mitigation was meant as an obligation in place of the City's responsibility to adopt the least environmentally damaging practicable alternative, as opposed to an obligation in addition to it."); *Florida Keys Citizens Coalition, Inc. v. U.S. Army Corps of Engineers*, 374 F. Supp. 2d 1116, 1132, 1134-35 (S.D. Fla. 2005) (upholding the USACE's Section 404 permit granted upon finding that "[t]he project as proposed with minimization efforts and mitigation ... is the least damaging practicable alternative.").

provided to you on May 31 (attached hereto as Attachment VI), CMP will provide donations totaling \$22 million to support and enhance tourism and outdoor recreation in Central and Northern Somerset County, including for the construction, operation, and staffing of a visitor center, maintenance of trails, maintenance costs associated with tourism infrastructure, and funding of educational and other programs to improve local tourism. CMP also will evaluate, and negotiate in good faith, donations of CMP land for trails, huts, Kennebec River leases, and other recreational infrastructure or amenities benefitting the region.

These mitigation and community benefits commitments will only be realized in the event that the Preferred Alternative is permitted and constructed, and support the conclusion that the Preferred Alternative will not have any unreasonable impacts.

As demonstrated above and in its applications, CMP incorporated environmentally sensitive design principles and components according to planning and siting, design, and offset strategies and mitigation to minimize potential aesthetic impacts of the overhead crossing. This Preferred Alternative has been located, designed, and landscaped to minimize its visual impact to the fullest extent possible. For these reasons, the impact of the Preferred Alternative is minimal and it will not unreasonably interfere with existing scenic, aesthetic, recreational, or navigational uses of the Kennebec River.

There is no reasonable alternative to the Preferred Alternative.

Conversely, the other alternatives analyzed are unreasonable.

1. The Brookfield Alternative is unreasonable.

The Brookfield Alternative would cross the Kennebec River just downstream of Harris Dam, and would require co-location with Section 222 within the Hydro Project area on the east side of the Kennebec River. No transmission line currently crosses the Kennebec River in this location. The river crossing (structure to structure) would be about 1,200' and would require 90°+/- angle structures on both the east and west sides. As explained in our Site Law and NRPA applications, this alternative would require creation of a new corridor, and widening of an existing corridor, about 900' of which would involve Brookfield Renewables-owned land that is encumbered by the Moosehead Kennebec Headwaters conservation easement.

In addition to the new corridor and widening of the existing corridor, the Brookfield Alternative would be visually prominent and would therefore have a significant visual impact on recreational users of the upper Kennebec Gorge and Indian Pond area. As demonstrated by the photosimulations provided to the DEP on June 29, 2018, structures on both sides of the river would be visible to all boaters, and there is no way to screen these structures. The Brookfield Alternative would be visible to all rafters and private boaters putting in to the Kennebec River and most likely would be directly over the stairway and marshaling area where rafters receive instruction before launching. The average time spent at the put-in underneath the Brookfield Alternative crossing site is 20 to 30 minutes. Were boaters to look

upstream, the Brookfield crossing site would be visible for 0.25 to 0.5 mile after entering the river. Accordingly, the Brookfield Alternative creates no less impact on existing scenic and aesthetic uses than the Preferred Alternative.

Furthermore, the Brookfield Alternative is 6.3 miles longer than the Preferred Alternative, and has greater impact on conserved lands. As acknowledged in your letter, the Brookfield Alternative would entail additional natural resource impacts, as it would require more clearing and would cross a greater number of streams, NWI mapped wetlands, inland waterfowl and wading bird habitat, and significant sand and gravel aquifers than does the Preferred Alternative. See Attachment IV, Response to the February 23, 2018 USACE Information Request, Kennebec River Crossing Overhead Alternative Comparison at Response 8 (Mar. 23, 2018).

Given the additional \$30 million cost of the Brookfield Alternative, with no less visual impact and significantly greater natural resource impacts, this alternative is not reasonable. And importantly, as noted previously, the off-site mitigation proposed for the Preferred Alternative would not be realized if the overhead crossing is not approved at the Preferred Alternative location.

Furthermore, the time needed for acquisition of rights and federal permissions required for the Brookfield Alternative is not practicable. Based on our experience siting and acquiring the needed rights on this Project, as well as recent discussions with Weyerhaeuser Company, the timeframe required to acquire a new corridor for the Brookfield Alternative and connect to the Preferred Route, including preliminary environmental work, would be two to three years and would have a probability of success of less than 50%. Approximately 6.4 miles of new corridor would need to be acquired from Weyerhaeuser Company, which is willing to discuss a sale of rights only if there is absolutely no impact to the Moosehead Region conservation easement. A reasonable timeline to negotiate an agreement and perform the necessary wetlands, vernal pools, and other natural resource surveys, land survey, and monumentation (marking of new ownership boundaries), would not allow CMP to take ownership of any Weyerhaeuser land until late 2019.

This alternative would also require that CMP acquire rights from Brookfield Renewables, which may refuse. Brookfield would also need to agree to reopen its FERC license or otherwise obtain FERC approval, triggering a protracted agency review process. Finally, the new corridor would cross the Moosehead Kennebec Headwaters conservation easement and require a release from both the easement holder and the DEP. A reasonable timeline to negotiate the necessary agreements and perform the necessary wetlands, vernal pool, and other natural resource surveys, land survey and monumentation, would not allow CMP to take ownership of any Brookfield or conservation easement land until late 2020. Based on the above, the cumulative probability of successful land rights acquisition for the Brookfield Alternative is estimated to be approximately 30%; in any case, this would not be accomplished within a timeframe that would allow CMP to meet its NECEC Massachusetts RFP in-service date contractual obligations.

Placing the overhead crossing just outside of the FERC project boundary⁹ would require obtaining rights only from Weyerhaeuser Company but would still not be reasonable because the timeframe for acquisition of such rights, as stated above, would not accommodate the project schedule. Additionally, locating the overhead crossing outside of the FERC boundary would place the transmission line in a location similar to the CMP Land Alternative, as described in the NRPA application. In fact, the segment of the Kennebec River just south of the FERC project boundary is more properly part of the Kennebec Gorge, contains Class III and Class IV rapids, and is central to the whitewater rafting and kayaking experience on the river.

As explained in Mark Goodwin's June 11, 2018 email to the agency officials present at the May 31, 2018 meeting at DEP's Augusta office, the estimated construction start date is late 2019, which is necessary to meet the obligations of the Massachusetts RFP. See Attachment VIII. Any delay in this start date would significantly undermine and penalize the NECEC Project, and thus such an alternative would not meet the Project's purpose, as described in the Site Law and NRPA applications.

For these reasons, neither the Brookfield Alternative, nor the variation of the Brookfield Alternative that is outside of the FERC project boundary, is a reasonable alternative.

2. The Underground Transmission Alternative is unreasonable.

Nor is the Underground Transmission Alternative (horizontal directional drilling) reasonable. The attached Power Engineers Report contains details on the Underground Transmission Alternative. See Attachment IX, Power Engineers *HVDC Underground Transmission Line Crossing Report* (Nov. 22, 2017). CMP anticipates there would be significant natural resource impacts associated with this alternative based on the extent of clearing and road improvements necessary to construct and maintain the Cable Termination Stations. The HVDC underground cable installation would require approximately 1,500' of open trenching to connect to the Cable Termination Stations on each side of the river, each of which would occupy an approximate 200' by 250' station footprint. See Attachment IV, Response to the February 23, 2018 USACE Information Request, Section 2.4.1.2.2, Directional Drill Alternative, at Response 9 (Mar. 23, 2018); Attachment III, Response to the November 20, 2017, and December 12, 2017 MDEP Information Requests, at Response 2 (Mar. 29, 2018).

Furthermore, upgrades on approximately fifteen miles of unimproved roads and associated bridges would be required to provide access to the Termination Stations in addition to the grading necessary for the stations and laydown area for drilling equipment. *Id.* Existing access roads would need to be improved by widening and by adding gravel, permanent culverts, and/or bridges, and these access roads would need to be maintained after construction to provide year-round access to the Termination Stations. Improved access adjacent to portions of the Cold Stream Forest conservation area may result in more intensive use adjacent to the conserved lands and sensitive brook trout habitat.

⁹ See Attachment VII (FERC project boundary map).

Conversely, access for overhead construction is achieved with fewer impacts and fewer permanent improvements (for example, matting would be used for vehicle access), and there is normally little or no ongoing maintenance requiring heavy equipment or motorized vehicles following construction of overhead lines.

Numerous operational issues with the Underground Transmission Alternative also make it unreasonable. See Site Law Application Section 25.3.1.2.2; NRPA Application Section 2.4.1.2.2. For example, underground transmission lines are more difficult to inspect, trouble-shoot, and maintain than overhead transmission lines. In the event of a line outage, CMP can inspect, identify, and repair deficiencies on an overhead transmission line much more quickly than an underground line.

Compounding these operational issues is the technical difficulty and challenge of installing the transmission line underground and beneath the Kennebec River. Unfavorable ground conditions can cause the horizontal directional drilling installation to fail during the drilling of the pilot hole. So too can the pilot hole collapse, resulting in immobilization and failure of the drill head. Formations of alternating geological strata also can push the drill assembly off-course and can require long drill lengths, both of which can contribute to the probability of failure. Multiple unsuccessful attempts at drilling the crossing would also increase the overall cost of this type of construction.

The additional estimated cost of the Underground Transmission Alternative is not financially practicable or reasonable. This alternative would total 3.9% of the overall Project cost, compared with the Preferred Alternative totaling only 0.6% of the overall Project cost. See Attachment IV, Response to the February 23, 2018 USACE Information Request, Section 2.4.1.2.2, Directional Drill Alternative, at Response 9 (Mar. 23, 2018); Attachment III, Response to the November 20, 2017, and December 12, 2017 MDEP Information Requests, at Response 2 (Mar. 29, 2018). This additional cost, coupled with the additional construction challenges, resource impacts, and operational issues described above, render this alternative unreasonable and impractical. And importantly, as noted previously, the off-site mitigation proposed for the Preferred Alternative would not be realized if the overhead crossing is not approved at the Preferred Alternative location.

Finally, the Underground Alternative may not even be possible, which is an additional reason it is unreasonable. While the November 2017 Power Engineers *HVDC Underground Transmission Line Crossing Report* (Attachment IX to this letter) described how an underground crossing of the Kennebec River might be accomplished utilizing horizontal directional drilling, this report did not evaluate either the feasibility or the reasonableness of this alternative. Given significant stakeholder interest in the Kennebec River crossing, CMP continues to gather information to be in a better position to answer questions from the public.

Conclusion

In conclusion, when compared to the Brookfield Alternative and the Underground Transmission Alternative, CMP chose the Preferred Alternative for the following reasons:

- Shortest construction duration.
- Allows CMP to meet Massachusetts RFP in-service date and other contractual obligations.
- Lowest cost.
- Best with respect to public and construction crew safety.
- Least impacts associated with construction of new and improved roads.
- Least disruptive with respect to road traffic and recreational access to the river.
- Least disruptive of other infrastructure (i.e., Brookfield Renewables' Harris Hydro).
- Provides the greatest mitigation benefits (economic, community supported, etc.).
- Least environmental impact (supports the detail already provided).
- Engineering, design, and construction methods for the Preferred Alternative are proven, established, and best in class for the chosen technology.
- Most readily accessible for future maintenance and repair work.
- Best alternative with respect to property ownership and easement rights.

What's more, the Project as a whole provides the following benefits for Maine communities and consumers:

- \$40 – 45 million annually through lower future energy costs.
- \$23 million annually higher Gross Domestic Product.
- 1,700 jobs created during planning and construction, 2017 – 2022.
- \$18 million annually in property tax payments, particularly in Androscoggin, Franklin, and Somerset counties.
- 265,000 metric tons avoided annual CO₂ emissions.
 - ≈ 10% total of emissions related to Maine's electricity load.
- Enhanced broadband services in western Maine.
- **\$0 annual project costs to Maine utility customers.**

As demonstrated in the Site Law and NRPA applications as well as above, the Preferred Alternative will not unreasonably interfere with existing scenic, aesthetic, recreational, or navigational uses of the Kennebec River. 38 M.R.S. § 480-D(1). Nor will the Preferred Alternative adversely affect existing uses, scenic character, air quality, water quality, or other natural resources in the area. 38 M.R.S. § 484(3). It has been thoughtfully and properly planned, sited, and designed, and mitigation has been proposed and potential impacts minimized, such that the Preferred Alternative will not diminish the public enjoyment and appreciation of the scenic and aesthetic qualities of this river segment. See Chapters 315.8, 315.9, 375.14. Furthermore, CMP has demonstrated that no reasonable alternative exists which would have less adverse effect upon the natural and recreational features of this river segment, and has proposed

significant and regionally-supported off-site mitigation as part of the Preferred Alternative. 38 M.R.S. § 480-D(8). The Preferred Alternative simply is the least environmentally damaging practicable alternative.

Sincerely,



Gerry J. Mirabile
Manager – Environmental Projects
Central Maine Power Company

cc: Naomi Kirk-Lawler, LUPC
Jay Clement, ACOE
Larry Warren, Western Mountains & Rivers Corporation
Mark Goodwin, Burns & McDonnell
Matt Manahan, Pierce Atwood LLP

Attachment I

From: Lisa A. Gilbreath
To: "[Brown, Joshua](#)"
Subject: RE: LUPC Special Exceptions
Date: Thursday, June 15, 2017 2:27:00 PM
Attachments: [image001.jpg](#)
[image002.jpg](#)
[image003.jpg](#)
[image004.jpg](#)
[image005.jpg](#)

You're very welcome!

Lisa A. Gilbreath	
PIERCE ATWOOD LLP	PH 207.791.1397

From: Brown, Joshua [<mailto:Joshua.Brown@maine.gov>]
Sent: Thursday, June 15, 2017 2:23 PM
To: Lisa A. Gilbreath
Subject: RE: LUPC Special Exceptions

Lisa,

This is great, thank you!

Joshua.

From: Lisa A. Gilbreath [<mailto:lgilbreath@PierceAtwood.com>]
Sent: Thursday, June 15, 2017 1:48 PM
To: Brown, Joshua; 'Goodwin, Mark'
Cc: Hinkel, Bill; Horn-Olsen, Samantha; Matt Manahan; Mirabile, Gerry J. (Gerry.Mirabile@cmpco.com)
Subject: RE: LUPC Special Exceptions

Joshua,
You are correct that the unnamed zones are M-GN zones. Please find attached a KMZ file with the LUPC subdistricts identified, as well as a preliminary KMZ of the centerline and clearing limits.
Please let us know if you have any additional questions as you review.
Thanks,
Lisa

Lisa A. Gilbreath	
PIERCE ATWOOD LLP	PH 207.791.1397

From: Brown, Joshua [<mailto:Joshua.Brown@maine.gov>]
Sent: Monday, June 12, 2017 12:07 PM
To: Lisa A. Gilbreath; 'Goodwin, Mark'
Cc: Hinkel, Bill; Horn-Olsen, Samantha; Matt Manahan; Mirabile, Gerry J. (Gerry.Mirabile@cmpco.com)
Subject: RE: LUPC Special Exceptions

Lisa,

Thank you for the data. I noticed that some of the cells in the LURK column were empty, are these M-GN zones? Also, we were hoping for maps depicting the locations of these zones, are they forthcoming?

Joshua.

From: Lisa A. Gilbreath [<mailto:lgilbreath@PierceAtwood.com>]
Sent: Friday, June 09, 2017 3:42 PM
To: 'Goodwin, Mark'; Brown, Joshua
Cc: Hinkel, Bill; Horn-Olsen, Samantha; Matt Manahan; Mirabile, Gerry J. (Gerry.Mirabile@cmpco.com)
Subject: RE: LUPC Special Exceptions

Josh,

Please find attached a spreadsheet which shows the LUPC subdistricts that the proposed QMI Transmission Project will cross, from Concord to the Canadian border. The first sheet of the attached spreadsheet has the individual intersections by acres. The second sheet ("Summary By Town") has the total acres by subdistrict by town. As you can see in the attached spreadsheet, the proposed Project will cross the following subdistricts:

D-GN
D-RS
P-FP
P-FW
P-GP
P-RR
P-SL
P-WL

It is our understanding that the Project is an allowed use in each subdistrict, including those that require special exceptions for utility facilities. See, e.g., Chapter 10, Sub-Chapter II, Sec. 1.3.f ("All uses not expressly allowed, with or without a permit or by special exception, shall be prohibited in P-RR subdistricts.").

It further is our understanding that the DEP's Site Law and NRPA review of the Project will consider all applicable standards that the LUPC would otherwise consider in granting a special exception. Utility facilities may be allowed as a special exception in the P-RR and P-WL subdistricts that the Project will cross. LUPC permits by special exception require a substantial showing that:

- a. There is no alternative site which is both suitable to the proposed use and reasonably available to the applicant;
- b. The use can be buffered from those other uses and resources within the sub-district with which it is incompatible; and
- c. Such other conditions are met that the Commission may reasonably impose in accordance with the policies of the Comprehensive Land Use Plan.

DEP's review of the Project will consider alternative sites under NRPA. See 06-096 CMR 310.5, 06-096 CMR 310.9(A), and 06-096 CMR 335.3(C). Both the Site Law and NRPA applications require a narrative and drawing of proposed buffers, and the Site Law further requires this in 06-096 CMR 375.9(D).

Accordingly, we believe that no additional permitting will be required of LUPC. Please let us know if you have any questions.

Thank you,
Lisa

Lisa A. Gilbreath

PIERCE ATWOOD LLP

PH 207.791.1397

From: Goodwin, Mark [<mailto:magoodwin@burnsmcd.com>]

Sent: Monday, June 05, 2017 1:55 PM

To: Brown, Joshua

Cc: Hinkel, Bill; Horn-Olsen, Samantha; Matt Manahan; Mirabile, Gerry J. (Gerry.Mirabile@cmpco.com); Lisa A. Gilbreath

Subject: RE: LUPC Special Exceptions

Josh:

Sorry for the delay, we are preparing special exception documentation and our goal is to deliver it to the LUPC by the end of this week.

Thanks,

Mark Goodwin, CPESC \ Burns & McDonnell

Senior Environmental Scientist

207-517-8482 \ **Mobile** 207-416-5707

magoodwin@burnsmcd.com \ burnsmcd.com

27 Pearl Street \ Portland, ME 04101



Proud to be one of *FORTUNE's* 100 Best Companies to Work For

Please consider the environment before printing this email.

This email and any attachments are solely for the use of the addressed recipients and may contain privileged client communication or privileged work product. If you are not the intended recipient and receive this communication, please contact the sender by phone at 816-333-9400, and delete and purge this email from your email system and destroy any other electronic or printed copies. Thank you for your cooperation.

From: Brown, Joshua [<mailto:Joshua.Brown@maine.gov>]

Sent: Monday, June 05, 2017 9:18 AM

To: Goodwin, Mark <magoodwin@burnsmcd.com>

Cc: Hinkel, Bill <Bill.Hinkel@maine.gov>; Horn-Olsen, Samantha <Samantha.Horn-Olsen@maine.gov>

Subject: LUPC Special Exceptions

Good morning Mark,

Just checking in to ask when you might be able to provide us with the areas along the proposed transmission line route that will require special exception? As you know we are very anxious to start the process ASAP to be able to meet your deadlines.

If it makes sense for us to go directly to CMP for this information, or otherwise other means to expedite the process please let us know.

Thank you!

Joshua Brown, Regional Representative

Department of Agriculture, Conservation, and Forestry

Land Use Planning Commission

131 Fyfe Road, PO Box 307

W. Farmington, ME 04992

207-670-7492

joshua.brown@maine.gov

Attachment II

**AGREEMENT FOR CONVEYANCE OF REAL PROPERTY
THE KENNEBEC RIVER GORGE TRACT**

THIS AGREEMENT FOR THE CONVEYANCE OF REAL PROPERTY (the "Agreement") is made between **CENTRAL MAINE POWER COMPANY**, a Maine corporation with a mailing address of 83 Edison Drive, Augusta, 04336 ("CMP") and **STATE OF MAINE, ACTING BY AND THROUGH ITS DEPARTMENT OF CONSERVATION, BUREAU OF PARKS AND LANDS**, an agency of the State of Maine with a mailing address of 22 State House Station, Augusta, Maine 04333-0022 ("MDOC"). The date that this Agreement has been fully executed shall be termed the "Effective Date".

Whereas CMP owns certain lands located in West Forks Plantation, Moxie Gore (T1 R5 BKP EKR), Chase Stream (T1 R6 BKP WKR), Squaretown (T2 R5 BKP EKR), and Indian Stream (T1 R6 BKP EKR), all in Somerset County, Maine, being more particularly described in Exhibit A-1, below, together with certain appurtenant easement described in Exhibit A-2, below and subject to certain exceptions and reservations described in Exhibit B-1, below; and

Whereas CMP desires to convey such lands to the MDOC as a gift to the people of the State of Maine; and

Whereas the MDOC desires to accept such lands as a gift on behalf of the people of the State of Maine;

Now Therefore, in consideration of the mutual covenants, agreements and promises of the parties, the adequacy of which is acknowledged, CMP agrees to convey and MDOC agrees to accept the land and all improvements thereon described on Exhibit A, attached hereto or incorporated herein, (the "Land"), together with any, improvements on the Land or attached thereto and all rights, privileges, easements and appurtenances thereto, including without limitation, CMP's right, title and interest in and to all air rights, water rights and any easements, rights-of-way or other interests in, on, under or to any, highway, street or right-of-way abutting or adjoining the Land, collectively with the Land, the "Property".

Special Condition.

1. CMP will convey the approximately 66.0 acres parcel in West Forks Plantation shown as Parcel A and Parcel B on Sheet 8 of "Boundary Survey of the Kennebec River Gorge Rte 201 to the Indian Pond Project (Harris Dam), West Forks, Moxie Gore, Chase Stream, Squaretown and Indian Stream, Somerset County, Maine" dated September 23, 2010 (Sheet 1 of 8) and October 6, 2010 (Sheet 2 of 8 through Sheet 8 of 8), revised through August 25, 2011 (Sheet 2 of 8 through Sheet 7 of 8), August 26, 2011 (Sheet 1 of 8) and August 28, 2011 (Sheet 8 of 8) and recorded at the Somerset County Registry of Deeds ("SCRD") in Plan File 2011, Pages 72 -79 (the "Plan") to the Inhabitants of West Forks Plantation within six months of the Closing Date, as defined below. In the event CMP does not convey either or both said Parcel A and Parcel B to the Inhabitants of West Forks Plantation within six months of the Closing Date, CMP covenants and agrees to convey either or both such remaining Parcels to the Maine Department of Conservation, Bureau of Parks and Lands. Further, CMP covenants and agrees (i) to place certain restrictions and covenants on Parcel A pursuant to State of Maine Department of Environmental Protection Site Location of Development Act and Natural Resources Protection Act Orders, Project Number #L-24620-26-A-N/L-24620-TG-B-

N/L-24620-VP-C-N/L-24620-IW-D-N/L-24620-L6-E-N and U.S. Army Corps of Engineers Permit Number NAE-2008-03017; and (ii) that it will place deed covenants on any conveyance to the Inhabitants of West Forks Plantation such that if said Inhabitants ever decide to sell said Parcel A, said Inhabitants must first offer said Parcel A as a gift, without compensation other than reimbursement of reasonable closing costs, to the State of Maine, Department of Conservation.

The provisions of this Special Condition paragraph shall survive Closing

2. Inspection Contingency.

- (a) During the term of this Agreement, MDOC may, upon reasonable notice to CMP and at MDOC's sole cost, expense and risk, examine, investigate and inspect the Property to obtain any and all information that MDOC deems appropriate regarding the property, including, without limitation, operating information, environmental conditions, physical nature and condition of the Property. Within sixty (60) days of the Effective Date, MDOC may, at MDOC's sole discretion, notify CMP in writing of MDOC's decision not to accept the Property and this Agreement will become null and void with no further obligations on either CMP or MDOC except MDOC will return to CMP all CMP's Information described in Section 2(b), below.
- (b) CMP will provide to MDOC, at no cost to MDOC, copies of any of CMP's plans, surveys, environmental reports, inspections and/or maintenance records of the Property ("CMP's Information"). CMP makes no representation or warranty regarding the accuracy or completeness of CMP's Information.
- (c) CMP will pay at Closing the reasonable costs of MDOC's due diligence not to exceed Two thousand Five Hundred (\$2,500.00) Dollars.

3. Closing of Conveyance.

Delivery of the deed to MDOC and acceptance of the deed by MDOC (the "Closing") shall occur prior to December 31, 2011 (the "Closing Date"). The precise Closing Date and time shall be mutually agreed upon by CMP and MDOC, and the Closing shall take place at a location mutually agreed upon by CMP and MDOC.

4. Title and Survey.

(a) CMP shall convey the Property to MDOC by good and sufficient Quit Claim with Covenant deed (the "Deed"). Title to the Property shall be good and marketable subject only to zoning restrictions, and such taxes for the current tax year as are not due and payable as of the date of Closing and to any defects of title accepted by MDOC.

(b) CMP shall perform certain survey work on the Property prior to the Closing. The survey work shall include the following:

(i) a recordable plan (the "Plan") showing all property lines and monuments that define the Land, retained land of CMP, easements benefiting the Land, the locations of public and private roads, and the locations of reserved or excepted easements on the Land; and

(ii) marking of property lines (blaze and paint) except for the 820 foot contour line in West Forks, property lines in common with MDOC, and the property lines in Chase Stream, Squaretown and Indian Stream, which shall have monuments set only; and

(c) MDOC shall notify CMP within sixty (60) days of the Effective Date of any defects in title that would make CMP unable to give title to the Property as stipulated herein (referred to herein as "Defects of Title") or of any other matter existing as of the date of this Agreement that would cause the Property not to conform with the provisions hereof. If MDOC gives CMP notice of any Defect of Title or nonconformity of the Property on or prior to Closing, CMP shall have sixty days after receipt of notice of such defect within which to remedy or cure any such Defect of Title or nonconformity, and the Closing shall be extended accordingly, if necessary. CMP shall use its best efforts to cure such Defect of Title or nonconformity, provided, however, that CMP shall not be obligated to spend more than Five thousand (\$5,000.00) dollars to cure such Title Defect. If, despite such best efforts, such Defect of Title or nonconformity cannot be corrected or remedied within such time period, then MDOC may elect either to (i) accept title to the Property subject to the uncured Defect of Title or nonconformity, or (ii) MDOC may elect to terminate this Agreement, and all obligations of the parties hereunder shall cease and neither party shall have any claim against the other by reason of this Agreement.

5. Closing Procedure. The parties shall exchange the following funds and documents on or prior to the Closing Date:

- (a) **CMP's Deposits:** The Deed, a FIRPTA affidavit, an underground storage tank notification, an appropriate Maine residency form, a settlement statement and such other documents as may be reasonably necessary or customary to effectuate the Closing.
- (b) **MDOC's Deposits:** Acceptance of the deed pursuant to this Agreement and such other documents as may be reasonably necessary or customary to effectuate the Closing.

6. Proration and Adjustments.

- (a) **Property Taxes.** CMP agrees to pay all real estate property taxes assessed with respect to the Premises through the tax year ending June 30, 2012 and also any penalties and interest. CMP shall be totally responsible for any taxes, interests, costs and penalties due for prior years and agrees to pay all taxes due during the period that CMP owns the fee interest in the Premises and including those taxes based upon the assessment date prior to the Closing Date. CMP shall provide evidence to Purchaser at Closing that all current tax bills and betterments have been paid.
- (b) **MDOC's Costs.** MDOC shall pay no other costs associated with this sale, except as provided in part (d) below.
- (c) **CMP's Costs.** CMP shall pay for all transfer taxes payable upon recordation, the cost of any surveys required by CMP, the cost of all title insurance required by CMP and MDOC, and all recording costs.
- (d) Each party shall be responsible for its own internal costs related to the transaction.

The provisions of this Section 6 shall survive closing.

7. Default. In the event either party shall default on any of its obligations herein, the non-defaulting party may seek to employ any and all available legal and equitable remedies. In the event any dispute arises between the parties under this Agreement, resolution thereof shall first be sought by negotiation between representatives of the parties. Arbitration of any dispute shall only occur if both CMP and MDOC fail to resolve said dispute within a reasonable time. The process, nature and binding effect of any arbitration agreed to hereunder shall be determined by mutual agreement of CMP and MDOC, and in the absence of such agreement arbitration shall not occur.

8. Brokers /Commissions. Each of the parties hereto will pay or discharge (a) any and all claims or liabilities for brokerage commissions or finder's fees incurred by reason of any action taken by that party with respect to this transaction, and (b) any and all claims and liabilities for brokerage commissions or finders' fees arising from or through persons or entities claiming by or through that party with respect to this transaction.

9. Notices. All required notices shall be given in writing, mailed postage prepaid, by certified or registered mail, return receipt requested, by nationally recognized overnight air courier service, by personal delivery or by electronic facsimile to the addresses indicated below, or such other places as the parties may designate in writing to one another:

CMP:
Central Maine Power Company
83 Edison Drive
Augusta, Maine 04336
Attention: Alice Richards
Real Estate Services
Email: alice.richards@cmpco.com
Tel. No.: (207) 626-9817

MDOC:
State of Maine
Dept. of Conservation, Bureau of Parks and Lands
22 State House Station, Augusta, Maine 04333-0022
Attn: Willard Harris, Director

And Copy to:
Jane Surran Pyne, Esq.
P.O. Box 601, Waldoboro, ME 04572

10. Time. Time is of the essence in this Agreement. In any case where a date for performance by either party shall fall on a Saturday, Sunday or holiday, the time for performance shall automatically extend to the next regular business day.

11. Governing Law. This Agreement shall be governed by and construed in accordance with the laws of the State of Maine.

12. Entire Agreement. This Agreement (including exhibits) constitutes the entire agreement between the parties with respect to this transaction. This Agreement may not be changed or modified except by instrument in writing signed by the parties.

13. Bind and Inure, Risk of Loss. The terms, covenants and conditions herein shall bind and inure to the benefit of the successors and assigns of the parties. All risk of loss to the Property prior to the Closing shall be on CMP.

14. No Assignment. Neither party may assign its rights in and to this Agreement without the prior written consent of the other party, except to affiliates of CMP and MDOC, respectively and, furthermore, it is agreed and understood that any merger of CMP or MDOC with another company or agency shall not be considered an assignment.

15. Severability. If any section, clause or part of this Agreement is found unenforceable, the finding shall not affect the remainder of this Agreement.

16. Headings. Section headings are solely for means of reference and are not intended to modify, explain or place any construction on any of the provisions of this Agreement.

17. Authority of Parties. MDOC and CMP represent, warrant and covenant to each other that they have the full power and authority to perform and comply with the execution and delivery of this Agreement. Further, the persons executing this Agreement on behalf of MDOC and CMP each hereby represent and warrant that he or she has the requisite and necessary authority to execute this Agreement on behalf of such party.

18. No Representations or Warranties Outside Agreement. This Agreement is the entire Agreement of the parties, and MDOC agrees that neither CMP nor its representatives has made any representation regarding the subject matter of this sale, including representations as to the physical nature or condition of the land, the improvements, the fixtures or appurtenances annexed thereto, or the personal property, if any, to be transferred to MDOC, except as expressly stated in this Agreement. Furthermore, CMP and MDOC each agree that in performing under this Agreement, each has not and shall not rely upon any statement or information from anyone claiming to represent the other party hereto, and the other party hereto is not and shall not be liable or bound by any such statement and/or information.

19. Representations or Warranties. CMP represents and warrants to MDOC that the following are true as of the date of this Agreement and will be true as of the Closing:

(i) CMPC has no actual knowledge of the existence of any material violations of laws or regulations affecting the Property. CMP has not received any notice from any federal, state or local governmental authority or representative thereof claiming or inquiring into the existence of any such violation.

(ii) There is no action, suit, legal proceeding or other proceeding pending or threatened (or, to the best knowledge of CMP, any basis therefore) against CMP of affecting any

portion of the Property in any court or before any arbitrator of any kind or before any governmental body that may materially or adversely affect the transactions contemplated by this Agreement or which may affect any portion of the Property.

(iii) CMP has not knowingly released or disposed of any "Hazardous Substance" (as defined below) on, in or from the Property and CMP is, to the best of its knowledge, not aware of the release or disposal of any Hazardous Substance on, in or from the Property at any time by anyone else. The term "Hazardous Substance" as used herein means any material, the generation, storage, handling, release, transportation or disposal of which is regulated by any federal, state or local law or regulation.

(iv) CMP has no actual knowledge of any pending or threatened actions or proceeding regarding condemnation of the Property or any part thereof.

(v) CMP has good and marketable title to the Property, free and clear of all liens and encumbrances.

20. Use of Retained Lands. MDOC acknowledges that CMP is an electric utility company and is retaining ownership of a 300 foot wide corridor (a portion of the "retained lands") north of Moxie Stream and Cold Stream for utility purposes including, but not limited to, the construction and operation and maintenance of overhead electric transmission lines, substations and appurtenant facilities. MDOC, for itself and its successors and assigns, covenants and agrees with CMP that this conveyance shall not be the basis for objecting to any future proposal by CMP to use the 300 foot wide corridor and appurtenant reserved access rights for such purposes. The provisions of this Section shall survive Closing.

IN WITNESS WHEREOF, the parties hereto have executed this Agreement on the dates immediately following their signatures.

CENTRAL MAINE POWER COMPANY

TIN # 01-0042740

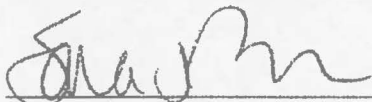

Sara J. Burns, President
and Chief Executive Officer

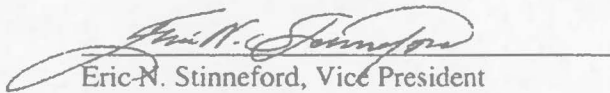

Eric N. Stinneford, Vice President
Treasurer, Controller and Clerk

Dated: September 1, 2011

MAINE DEPARTMENT OF CONSERVATION
BUREAU OF PARKS AND LANDS

TIN#

Willard Harris, Director

Dated: Sept 1, 2011

Exhibit A-1 Conveyed Lands

Subject to the reservations and exceptions as defined in Exhibit B-1, below, the following eight parcels of land:

Certain lots of land situated on both sides of and including the Kennebec River located within Indian Stream Township T1R6 BKP EKR, Squaretown Township T2R5 BKP EKR, Chase Stream Township T1R6 BKP WKR, West Forks Plantation and Moxie Gore T1R5 BKP EKR, County of Somerset, State of Maine, as shown on a plan entitled "Boundary Survey of the Kennebec River Gorge Rte 201 to the Indian Pond Project (Harris Dam), West Forks, Moxie Gore, Chase Stream, Squaretown and Indian Stream, Somerset County, Maine" dated September 23, 2010 (Sheet 1 of 8) and October 6, 2010 (Sheet 2 of 8 through Sheet 8 of 8), revised through August 25, 2011 (Sheet 2 of 8 through Sheet 7 of 8), August 26, 2011 (Sheet 1 of 8) and August 28, 2011 (Sheet 8 of 8) and recorded at the Somerset County Registry of Deeds ("SCRD") in Plan File 2011, Pages 72 -79 (the "Plan"). Said lots being more particularly described as follows:

PARCEL 1

INDIAN STREAM TOWNSHIP

Beginning at a 5/8 inch iron rebar set with cap "SGC ENG PLS 2147" on the contour line at elevation 820 feet based on NAVD88 datum and on the bounds of land now or formerly of FPL Energy Maine Hydro LLC by deed recorded at the SCR D in Book 2540, Page 24, said rebar located South 62°10'59" East a distance of 314.99 feet from the base of a galvanized iron pipe found 30 inches high in Chase Stream Township and North 62°10'59" West a distance of 1028.06 feet from the base of a galvanized iron pipe found 14 inches high in Indian Stream Township;

Thence running southwesterly along a contour line at elevation 820 feet based on said NAVD88 datum to a point on the presumed Township Line between Squaretown Township to the south and Indian Stream Township to the north with tie lines witnessed by 5/8 inch iron rebar set with caps "SGC ENG PLS 2147" on said contour line as follows:

From the point of beginning South 27°41'56" West a distance of 388.0 feet to a 5/8 inch iron rebar set as described;

Thence South 40°11'19" West a distance of 1102.64 feet to a 5/8 inch iron rebar set as described;

Thence South 50°29'37" West a distance of 1048.62 feet to a 5/8 inch iron rebar set as described;

Thence South 48°23'09" West a distance of 539 feet, more or less, to a point on said presumed Township Line between Squaretown and Indian Stream;

Thence westerly along said Township Line a distance of 150 feet, more or less, to the thread of the Kennebec River;

Thence northeasterly along the thread of the Kennebec River approximately 3247 feet, more or less, to a point on the southwesterly side of said land of FLP Energy Maine Hydro LLC;

Thence South 62°10'59" East by and along said land of FPL Energy Maine Hydro, LLC a distance of 30 feet, more or less, to the Point of Beginning.

Meaning and intending to convey all land westerly of elevation 820 feet within the above described Township and to the thread of the Kennebec River, containing 6.1 acres, more or less. Bearings and distances are based on Grid North, NAD 83, UTM Zone 19.

PARCEL 2

SQUARETOWN TOWNSHIP

Beginning at a point on the contour line at elevation 820 feet based on NAVD88 datum and at the presumed intersection of the Township Line between Indian Stream on the north and Squaretown on the south, being South 48°23'09" West a distance of 539 feet, more or less, from a 5/8 inch iron rebar set with cap "SGC ENG PLS 2147" on elevation 820 feet;

Thence running southwesterly along said contour line at elevation 820 feet, a distance of 140 feet, more or less, to a point on the presumed Township Line of Squaretown to the east and Moxie Gore to the west;

Thence running northwesterly along said Township Line between Squaretown and Moxie Gore a distance of 80 feet, more or less, to the presumed intersection where Squaretown Township, Moxie Gore and Indian Stream Township all meet;

Thence running easterly along said Township Line between Squaretown and Indian Stream a distance of 120 feet, more or less, to the Point of Beginning.

Meaning and intending to convey all land northwesterly of elevation 820 feet within the Squaretown Township to the thread of the Kennebec River, containing 0.11 acres, more or less. Bearings and distances are based on Grid North, NAD 83, UTM Zone 19.

PARCEL 3

CHASE STREAM TOWNSHIP

Beginning at a 5/8 inch iron rebar set with cap "SGC ENG PLS 2147" on the contour line at elevation 820 feet based on NAVD88 datum and on the southwesterly bounds of land now or formerly of FPL Energy Maine Hydro LLC by deed recorded at the SCRD in Book 2540, Page 24, said rebar located South 62°10'59" East a distance of 142.07 feet from the base of a galvanized iron pipe found 30 inches high in Chase Stream Township and North 62°10'59" West a distance of 1200.98 feet from the base of a galvanized iron pipe found 14 inches high in Indian Stream Township;

Thence South 62°10'59" East by and along said land of FPL Energy Maine Hydro LLC, a distance of 140 feet, more or less, to the thread of the Kennebec River;

Thence running southwesterly along said thread of the Kennebec River a distance of 3247 feet, more or less, to the presumed Township line with Chase Stream Township on the north and West Forks Plantation on the south;

Thence westerly along said Township line a distance of 230 feet, more or less, to a point on the contour line at elevation 820 feet based on NAVD88 datum, said point being North 49°22'01" East a distance of 551 feet, more or less, from a 5/8 inch iron rebar set with cap "SGC ENG PLS 2147" on said contour line at elevation 820 feet in West Forks Plantation

and easterly along said Township line a distance of 1308 feet, more or less, from a 5/8 inch iron rebar found on said Township line with cap "JAMES MOORE #2281";

Thence running Northeasterly along said contour line at elevation 820 feet based on NAVD88 datum to a point on the southwesterly bound of said land of FLP Energy Maine Hydro LLC with tie lines witnessed by 5/8 inch iron rebar set with cap "SGC ENG PLS 2147" on said contour line as follows:

From said Township line North 49°22'01" East a distance of 208 feet, more or less, to a 5/8 inch iron rebar set as described;

Thence North 45°34'50" East a distance of 699.68 feet to an iron rebar found;

Thence North 60°33'28" East a distance of 438.90 feet to a 5/8 inch iron rebar set as described;

Thence North 45°36'22" East a distance of 404.17 feet to a 5/8 inch iron rebar set as described;

Thence North 56°58'50" East a distance of 442.04 feet to a 5/8 inch iron rebar set as described;

Thence North 38°38'30" East a distance of 365.57 feet to a 5/8 inch iron rebar set as described;

Thence North 35°05'54" East a distance of 389.30 feet to a 5/8 inch iron rebar set as described;

Thence North 24°23'56" East a distance of 426.04 feet to a 5/8 inch iron rebar set as described and the Point of Beginning.

Meaning and intending to convey all land southeasterly of elevation 820 feet within the above described Township southwesterly of said land of FPL Energy to the thread of the Kennebec River, containing 8.70 acres, more or less.

Bearings and distances are based on Grid North, NAD 83, UTM Zone 19.

PARCEL 4

WEST FORKS NORTHERLY SECTION

Beginning at a point on the contour line at elevation 820 feet based on NAVD88 datum and on the Township line between Chase Stream Township on the north and West Forks Plantation on the south, said point being South 49°22'01" West a distance of 208 feet, more or less, from a 5/8 inch iron rebar set with cap "SGC ENG PLS 2147" and easterly along said Township line a distance of 1308 feet, more or less, from an iron rebar found on said Township line found with cap "JAMES MOORE #2281";

Thence northeasterly along said Township line a distance of 230 feet, more or less, to the thread of the Kennebec River;

Thence running in a general southwesterly direction along said thread of the Kennebec River a distance of approximately 7.27 miles to a point on land being retained by the Grantor, said point being North 52°16'13" West by and along said retained land of the Grantor a distance of 910 feet, more or less, from an iron rebar painted red and found firm and plumb in a ring of stones at the most westerly corner of lands now or formerly owned by Arthur E. and Sara

I. Wilder by deeds recorded at SCRD in Book 2496, Page 24 and in Book 2888, Page 26 located within Moxie Gore;

Thence North $52^{\circ}16'13''$ West by and along said retained land of the Grantor a distance of 690 feet, more or less, to a 5/8 inch iron rebar with cap "SGC ENG PLS 2147" set on the contour line at elevation 820 feet based on NAVD88 datum, next to the base of a wood post found lying on ground;

Thence running in a general northeasterly direction along a contour line at elevation 820 feet based on said NAVD88 datum as witnessed by 5/8 inch iron rebar with cap "SGC ENG PLS 2147" set at angle points of the following tie lines:

From said rebar set at the base of a wood post North $51^{\circ}07'21''$ East a distance of 532.01 feet, to a 5/8 inch iron rebar set with cap as described above;

Thence North $47^{\circ}56'30''$ East a distance of 633.93 feet to a 5/8 inch iron rebar set as described;

Thence North $45^{\circ}49'17''$ East a distance of 600.44 feet to a 5/8 inch iron rebar set as described;

Thence North $36^{\circ}23'26''$ East a distance of 454.99 feet to a 5/8 inch iron rebar set as described;

Thence North $27^{\circ}09'02''$ East a distance of 478.76 feet to a 5/8 inch iron rebar set as described;

Thence North $17^{\circ}56'35''$ East a distance of 498.82 feet to a 5/8 inch iron rebar set as described;

Thence North $24^{\circ}02'53''$ East a distance of 503.31 feet to a 5/8 inch iron rebar set as described;

Thence North $25^{\circ}55'48''$ East a distance of 515.34 feet to a 5/8 inch iron rebar set as described;

Thence North $08^{\circ}13'00''$ East a distance of 479.50 feet to a 5/8 inch iron rebar set as described;

Thence North $11^{\circ}06'06''$ West a distance of 544.82 feet to a 5/8 inch iron rebar set as described;

Thence North $10^{\circ}08'03''$ West a distance of 564.09 feet to a 5/8 inch iron rebar set as described;

Thence North $37^{\circ}39'54''$ West a distance of 505.25 feet to a 5/8 inch iron rebar set as described;

Thence North $64^{\circ}23'07''$ West a distance of 528.73 feet to a 5/8 inch iron rebar set as described;

Thence North $18^{\circ}16'32''$ West a distance of 578.97 feet to a 5/8 inch iron rebar set as described;

Thence North $07^{\circ}55'57''$ West a distance of 583.46 feet to a 5/8 inch iron rebar set as described;

Thence North 02°08'08" East a distance of 490.32 feet to a 5/8 inch iron rebar set as described;

Thence North 23°53'29" East a distance of 529.85 feet to a 5/8 inch iron rebar set as described;

Thence North 36°20'45" East a distance of 478.62 feet to a 5/8 inch iron rebar set as described;

Thence North 08°37'16" East a distance of 417.13 feet to a 5/8 inch iron rebar set as described;

Thence North 12°29'40" West a distance of 351.74 feet to a 5/8 inch iron rebar set as described;

Thence South 62°05'21" West a distance of 538.93 feet to a 5/8 inch iron rebar set as described;

Thence North 39°25'31" West a distance of 160.39 feet to a 5/8 inch iron rebar set as described;

Thence North 18°15'54" East a distance of 213.82 feet to a 5/8 inch iron rebar set as described;

Thence North 11°52'03" East a distance of 407.46 feet to a 5/8 inch iron rebar set as described;

Thence North 20°11'05" East a distance of 449.32 feet to a 5/8 inch iron rebar set as described;

Thence North 24°55'40" East a distance of 502.91 feet to a 5/8 inch iron rebar set as described;

Thence North 53°26'56" East a distance of 546.81 feet to a 5/8 inch iron rebar set as described;

Thence North 49°42'47" East a distance of 507.35 feet to a 5/8 inch iron rebar set as described;

Thence North 55°36'45" East a distance of 461.59 feet to a 5/8 inch iron rebar set as described;

Thence North 45°42'43" East a distance of 538.58 feet to a 5/8 inch iron rebar set as described;

Thence North 24°14'51" East a distance of 530.06 feet to a 5/8 inch iron rebar set as described;

Thence North 20°38'46" East a distance of 537.10 feet to a 5/8 inch iron rebar set as described;

Thence North 12°00'40" East a distance of 464.67 feet to a 5/8 inch iron rebar set as described;

Thence North 08°23'40" East a distance of 569.18 feet to a 5/8 inch iron rebar set as described;

Thence North 11°23'07" East a distance of 492.74 feet to a 5/8 inch iron rebar set as described;

Thence North $36^{\circ}50'39''$ East a distance of 607.80 feet to a 5/8 inch iron rebar set as described;

Thence North $59^{\circ}08'56''$ East a distance of 408.41 feet to a 5/8 inch iron rebar set as described;

Thence South $77^{\circ}07'51''$ East a distance of 627.10 feet to a 5/8 inch iron rebar set as described;

Thence North $29^{\circ}16'59''$ East a distance of 431.65 feet to a 5/8 inch iron rebar set as described;

Thence South $81^{\circ}09'29''$ East a distance of 467.39 feet to a 5/8 inch iron rebar set as described;

Thence North $39^{\circ}12'48''$ East a distance of 469.27 feet to a 5/8 inch iron rebar set as described;

Thence North $40^{\circ}43'52''$ East a distance of 459.48 feet to a 5/8 inch iron rebar set as described;

Thence North $58^{\circ}07'23''$ East a distance of 494.72 feet to a 5/8 inch iron rebar set as described;

Thence North $53^{\circ}09'24''$ East a distance of 444.39 feet to a 5/8 inch iron rebar set as described;

Thence North $53^{\circ}43'59''$ East a distance of 421.63 feet to a 5/8 inch iron rebar set as described;

Thence North $71^{\circ}24'32''$ East a distance of 207.43 feet to a 5/8 inch iron rebar set as described;

Thence North $30^{\circ}52'36''$ East a distance of 501.63 feet to a 5/8 inch iron rebar set as described;

Thence North $56^{\circ}40'29''$ East a distance of 486.59 feet to a 5/8 inch iron rebar set as described;

Thence North $82^{\circ}58'54''$ East a distance of 556.26 feet to a 5/8 inch iron rebar set as described;

Thence North $56^{\circ}13'03''$ East a distance of 586.92 feet to a 5/8 inch iron rebar set as described;

Thence South $84^{\circ}01'49''$ East a distance of 399.80 feet to a 5/8 inch iron rebar set as described;

Thence North $31^{\circ}26'49''$ East a distance of 533.83 feet to a 5/8 inch iron rebar set as described;

Thence North $11^{\circ}26'13''$ East a distance of 499.14 feet to a 5/8 inch iron rebar set as described;

Thence North $01^{\circ}04'04''$ East a distance of 563.90 feet to a 5/8 inch iron rebar set as described;

Thence North $18^{\circ}49'11''$ East a distance of 571.32 feet to a 5/8 inch iron rebar set as described;

Thence North 32°09'12" East a distance of 565.47 feet to a 5/8 inch iron rebar set as described;

Thence North 35°24'48" East a distance of 338.49 feet to a 5/8 inch iron rebar set as described;

Thence North 48°48'54" East a distance of 472.85 feet to a 5/8 inch iron rebar set as described;

Thence North 48°24'57" East a distance of 487.19 feet to a 5/8 inch iron rebar set as described;

Thence North 29°53'40" East a distance of 513.78 feet to a 5/8 inch iron rebar set as described;

Thence North 23°45'52" East a distance of 358.37 feet to a 5/8 inch iron rebar set as described;

Thence North 30°39'11" East a distance of 387.59 feet to a 5/8 inch iron rebar set as described;

Thence North 34°22'40" East a distance of 502.65 feet to a 5/8 inch iron rebar set as described;

Thence North 37°05'19" East a distance of 1040.87 feet to a 5/8 inch iron rebar set as described;

Thence North 10°40'30" East a distance of 500.43 feet to a 5/8 inch iron rebar set as described;

Thence North 40°02'34" East a distance of 563.43 feet to a 5/8 inch iron rebar set as described;

Thence North 21°40'55" East a distance of 513.99 feet to a 5/8 inch iron rebar set as described;

Thence North 34°05'52" East a distance of 491.18 feet to a 5/8 inch iron rebar set as described;

Thence North 41°38'39" East a distance of 455.39 feet to a 5/8 inch iron rebar set as described;

Thence North 58°16'50" East a distance of 288.04 feet to a 5/8 inch iron rebar set as described;

Thence South 60°47'48" East a distance of 767.39 feet to a 5/8 inch iron rebar set as described;

Thence North 64°26'07" East a distance of 785.08 feet to a 5/8 inch iron rebar set as described;

Thence North 13°24'15" East a distance of 552.80 feet to a 5/8 inch iron rebar set as described;

Thence North 11°14'42" East a distance of 676.32 feet to a 5/8 inch iron rebar set as described;

Thence North 49°22'01" East a distance of 551 feet, more or less, to said Township line between West Forks Plantation and Chase Stream Township and the point of beginning.

Meaning and intending to convey all land southeasterly of elevation 820 feet and northerly of the retained lands of the Grantor within the above described Township to the thread of the Kennebec River within the above described bounds, containing 345.6 acres, more or less.

Bearings and distances are based on Grid North, NAD 83, UTM Zone 19.

PARCEL 5

WEST FORKS SOUTHERLY SECTION

Beginning at a point on the southeasterly bound of land now or formerly of Plum Creek Timberlands, LLC established by an exchange of deeds by and between S.D. Warren Company and Central Maine Power Company recorded at SCRD in Book 1416, Pages 120 and 127, reference being made to an "Amended Application for Authority to do Business" recorded in Book 2605, Page 152 for a change of name from SDW Timber II, LLC to Plum Creek Maine Timberlands, LLC, said point being at the westerly corner of land being retained by the Grantor, and being North $72^{\circ}49'01''$ East along said land of Plum Creek a distance of 1322.41 feet from a 4x4 wooden post found in a stone pile and South $72^{\circ}49'01''$ West along said lands of Plum Creek a distance of 525.16 feet from the base of a 4x4 wooden post found lying on the ground;

Thence South $52^{\circ}16'13''$ East passing through land of the Grantor a distance of 1360 feet, more or less, to the thread of the Kennebec River, being North $52^{\circ}16'13''$ West a distance of 1020 feet, more or less, from an iron rebar found firm and plumb with a red cap on the southwesterly bound of said retained land of the Grantor and also being at the northwesterly corner of land now or formerly owned by Arthur E. and Sara I. Wilder by a deed recorded at SCRD in Book 2521, Page 22 located within Moxie Gore;

Thence in a general southerly direction along the thread of the Kennebec River a distance of 2.94 miles, more or less, to a point that is the southeasterly extension of the northeasterly line of other land of the Grantor by deeds recorded at said SCRD in Book 536, Page 409 and in Book 536, Page 465;

Thence North $64^{\circ}36'22''$ West across said other land of the Grantor a distance of 260 feet, more or less, to an old, yellow, wooden post found in stones;

Thence continuing North $64^{\circ}36'22''$ West by and along said other land of the Grantor a distance of 893.11 feet to an old painted wooden post found at an intersection of blazed line of trees;

Thence North $21^{\circ}36'47''$ East by and along said lands of Plum Creek and generally following an old blazed line of trees, a distance of 1129.62 feet to the base of an old painted wooden post;

Thence North $53^{\circ}54'08''$ East by and along said lands of Plum Creek and generally following an old blazed line of trees, a distance of 944.89 feet to an angle point;

Thence North $73^{\circ}38'29''$ East by and along said lands of Plum Creek and generally following an old blazed line of trees, a distance of 443.97 feet to an old wooden post found on a steep slope at the base of a large oak tree;

Thence North $29^{\circ}54'31''$ West by and along said lands of Plum Creek and generally following an old blazed line of trees, a distance of 1089.53 feet to the base of an old wooden post;

Thence North $04^{\circ}11'15''$ West by and along said lands of Plum Creek and generally following an old blazed line of trees, a distance of 1042.38 feet to an angle point;

Thence North $11^{\circ}17'11''$ East by and along said lands of Plum Creek and generally following an old blazed line of trees, a distance of 693.30 feet to an old wooden post found in a stone pile;

Thence North $28^{\circ}48'15''$ East by and along said lands of Plum Creek and generally following an old blazed line of trees, a distance of 730.93 feet to an old wooden post;

Thence North $42^{\circ}44'54''$ East by and along said lands of Plum Creek and generally following an old blazed line of trees, a distance of 649.55 feet to the base of an old wooden post found leaning;

Thence North $64^{\circ}19'05''$ East by and along said lands of Plum Creek and an old blazed line of trees, a distance of 561.64 feet to the base of an old wooden post found leaning;

Thence North $67^{\circ}45'13''$ East by and along said lands of Plum Creek and generally following an old blazed line of trees, a distance of 355.24 feet to the base of an old wooden post found leaning;

Thence North $03^{\circ}42'52''$ West by and along said lands of Plum Creek and generally following an old blazed line of trees, a distance of 1600.25 feet to a 5/8 inch iron rebar found firm and plumb;

Thence North $42^{\circ}04'59''$ East by and along said lands of Plum Creek and generally following an old blazed line of trees, a distance of 1299.55 feet to a found 4x4 wooden post;

Thence North $22^{\circ}53'58''$ West by and along said lands of Plum Creek and generally following an old blazed line of trees, a distance of 1698.08 feet to the base of a found 4x4 wooden post, half rotted, painted yellow, found lying on the ground;

Thence North $03^{\circ}59'16''$ East by and along said lands of Plum Creek and generally following an old blazed line of trees, a distance of 700.72 feet to a found 4x4 wooden post;

Thence North $45^{\circ}25'34''$ East by and along said lands of Plum Creek and generally following an old line of blazed trees, a distance of 1059.44 feet to a found 4x4 wooden post found in a stone pile;

Thence North $72^{\circ}49'01''$ East by and along said lands of Plum Creek and generally following an old blazed line of trees painted red, a distance of 445.79 feet to a point being the northwest corner of a 3.03 acre lot retained by Central Maine Power Company (the "WMCF Parcel"), said point also being South $72^{\circ}49'01''$ West a distance of 876.62 feet of the point of beginning of this Parcel 5;

Thence South $17^{\circ}10'59''$ East by and along the WMCF Parcel a distance of 220.0 feet to the southwest corner of the WMCF Parcel;

Thence North $72^{\circ}49'01''$ East by and along the WMCF Parcel a distance of 600.0 feet to the southeast corner of the WMCF Parcel;

Thence North $17^{\circ}10'59''$ West by and along the WMCF Parcel a distance of 220.0 feet to the northeast corner of the WMCF Parcel and land now or formerly of Plum Creek;

Thence North $72^{\circ}49'01''$ East by and along said lands of Plum Creek and generally following an old blazed line of trees painted red, a distance of 276.62 feet to the point of beginning, containing 411.79 acres, more or less.

Bearings and distances are based on Grid North, NAD 83, UTM Zone 19.

PARCEL 6

MOXIE GORE NORTHERLY SECTION

Beginning at a point on the thread of Kennebec River at an intersection of the presumed Township lines between Chase Stream Township on the north, West Forks Plantation on the west at its most easterly corner, Indian Stream Township on the east at its most westerly corner and Moxie Gore on the Southeasterly side;

Thence Northeasterly along the presumed Township line between Indian Stream Township on the north and Moxie Gore on the south a distance of 37 feet, more or less, to a point at the intersection of presumed Township lines between Indian Stream Township on the north, Squaretown Township on the south and east at its northwesterly corner and Moxie Gore on the south and west at its northeasterly corner;

Thence southwesterly along the presumed Township line between Moxie Gore on the west and Squaretown Township on the east a distance of 80 feet, more or less, to the southerly corner of Parcel Two, described above;

Thence continuing Southeasterly along the presumed Township line between Moxie Gore on the west and Squaretown Township on the east a distance of 352 feet, more or less, to a point at the most northerly corner of land now or formerly of Draper Properties by deed recorded at said SCRD in Book 2888, Page 31, being Lot 10 as shown on the plan titled "Survey Plan Land of TM-Corporation Area XIV" dated March 31, 1989, prepared by Terrence S. Worcester and recorded at the SCRD in Plan File B-89, Page 47 said point being South $11^{\circ}31'58''$ East a distance of 351.87 feet from the southerly corner of Parcel Two, described above;

Thence South $46^{\circ}45'35''$ West by and along Lot 10 and said land of Draper a distance of 196.21 feet, more or less, to an iron rebar found with cap "RLS 1310";

Thence continuing South $46^{\circ}45'35''$ West by and along Lot 10 and said land of Draper a distance of 227.29 feet to an angle point;

Thence South $13^{\circ}32'10''$ West by and along Lot 10 and said land of Draper a distance of 1175.10 feet to the corner of Lots 9 and 10 as shown on said Plan of Area XIV and witnessed by an iron rebar found with cap "RLS 1310" ;

Thence South $42^{\circ}29'16''$ West by and along Lot 9 and said land of Draper a distance of 889.06 feet to an iron rebar found with cap "RLS 1310";

Thence North $89^{\circ}10'10''$ West by and along Lots 9 and 8 as shown on said Plan of Area XIV and said land of Draper a total distance of 847.97 feet to an iron rebar found with cap "RLS 1310";

Thence North $55^{\circ}17'19''$ West by and along Lot 8 and said land of Draper a distance of 467.98 feet to an angle point;

Thence South 30°48'34" West by and along Lot 8 and said land of Draper a distance of 427.25 feet to an angle point;

Thence South 10°58'50" West by and along Lot 8 and said land of Draper a distance of 340.57 feet to the corner of Lots 7 and 8 as shown on said Plan of Area XIV and witnessed by a 5/8 inch iron rebar found 8 inches above grade with cap "RLS 1310";

Thence South 29°30'09" West by and along Lots 7, 6 and 5 as shown on said Plan of Area XIV and said land of Draper Properties a total distance of 2488.03 feet to the corner of Lots 4 and 5 as shown on said Plan witnessed by a 5/8 inch iron rebar found firm and plumb with cap "RLS 1310";

Thence South 44°27'05" West by and along Lot 4 and said land of Draper a distance of 591.34 feet to a 5/8 inch iron rebar found with cap "RLS 1310";

Thence South 24°57'23" West by and along Lot 4 as shown on said Plan of Area XIV and said land of Draper Properties a distance of 235.79 feet to an unmonumented point at the corner of Lots 4 and 3 as shown on said Plan;

Thence continuing South 24°57'23" West by and along Lot 3 as shown on said Plan of Area XIV and said land of Draper Properties a distance of 813.08 feet to the corner of Lots 3 and 2 as shown on said Plan and witnessed by a 5/8 inch iron rebar found with cap "RLS 1310";

Thence South 40°31'34" West by and along Lot 2 as shown on said Plan of Area XIV and said land of Draper a distance of 873.46 feet to an unmonumented point at the corner of Lots 2 and 1 as shown on said Plan;

Thence continuing South 40°31'34" West by and along Lot 1 as shown on said Plan of Area XIV and said land of Draper a distance of 1,154.41 feet to a 5/8 inch iron rebar found with cap "RLS 1310";

Thence South 11°27'33" West by and along Lot 1 and said land of Draper a distance of 234.00 feet to the southwest corner of Lot 1 as shown on said Plan of Area XIV and the northwest corner of Lot 15 as shown on the plan titled "Survey Plan Land of TM-Corporation Area XIII" dated March 31, 1989, prepared by Terrence S. Worcester and recorded at the SCR D in Plan File B-89, Page 46, said corner being witnessed by a 5/8 inch iron rebar found with cap "RLS 1310";

Thence South 05°09'17" East by and along Lot 15 as shown on said Plan of Area XIII and said land of Draper a distance of 377.12 feet to a 5/8 inch iron rebar found with cap "RLS 1310";

Thence South 01°52'32" East by and along Lot 15 and said land of Draper a distance of 290.65 feet to the corner of Lots 14 and 15 as shown on said Plan of Area XIII and witnessed by a 5/8 inch iron rebar found with cap "RLS 1310";

Thence South 01°51'02" East by and along Lot 14 and said land of Draper a distance of 334.48 feet to a 5/8 inch iron rebar found with cap "RLS 1310";

Thence South 23°57'18" West by and along Lot 14 and said land of Draper a distance of 359.39 feet to the corner of Lots 13 and 14 as shown on said Plan of Area XII and witnessed by a 5/8 inch iron rebar found firm and plumb with cap "RLS 1310 E Pro Consultants";

Thence South 08°35'42" East by and along Lot 13 and said land of Draper a distance of 250.76 feet to a 5/8 inch iron rebar found firm and plumb with cap "RLS 1310 E Pro Consultants";

Thence South 27°44'38" East by and along Lot 13 and said land of Draper a distance of 580.35 feet to a point on the northerly bound of land being retained by the Grantor as described a deed recorded at SCRD in Book 1921, Page 327, said point being witnessed by a 5/8 inch iron rebar found firm and plumb with cap "RLS 1310";

Thence South 54°19'43" West by and along said land being retained by the Grantor a distance of 86.49 feet to an iron rebar found with cap "RLS 1310";

Thence North 67°58'38" West by and along said land being retained by the Grantor and land now of formerly of FPL Energy Maine Hydro LLC by deeds recorded at SCRD in Book 2540, Page 24 and Book 3240, Page 295 a total distance of 342.45 feet to an iron rebar found marking the easterly corner of an easement for the Carry Brook takeout area described in said deed to FPL recorded at SCRD in Book 3240, Page 295;

Thence South 57°41'09" West by and along said land of FPL on the southeast and said easement on the northwest, a distance of 226.81 feet to an iron rebar found;

Thence North 69°28'05" West by and along said land of FPL on the southwest and said easement on the northeast, a distance of 112.76 feet to the most westerly corner of said land of FPL and to said land being retained by the Grantor;

Thence South 69°22'53" West by and along said land being retained by the Grantor a distance of 469.63 feet to an iron rebar found";

Thence North 69°19'56" West by and along said land being retained by the Grantor a distance of 343.34 feet to an iron rebar found;

Thence South 52°51'18" West by and along said land being retained by the Grantor a distance of 174.15 feet to an iron rebar found;

Thence South 09°21'22" East by and along said land being retained by the Grantor a distance of 267.32 feet to a corner of land now or formerly of Draper Properties by same deed mentioned above, witnessed by an iron rebar found;

Thence South 84°31'35" West by and along Lot 9 as shown on said Plan of Area XIII and said land of Draper a distance of 767.73 feet to a 5/8 inch iron rebar found with cap "RLS 1310";

Thence South 61°55'54" West by and along Lot 9 and said land of Draper a distance of 452.75 feet to the corner of Lots 8 and 9 as shown on said Plan of Area XIII, witnessed by a 5/8 inch iron rebar found with cap "RLS 1310";

Thence South 22°46'57" West by and along Lot 8 and said land of Draper a distance of 576.71 feet to a 5/8 inch iron rebar found with cap "RLS 1310";

Thence South 56°11'01" West by and along Lot 8 and said land of Draper a distance of 828.75 feet to a 5/8 inch iron rebar found firm and plumb with cap "RLS 1310";

Thence South 30°46'08" East by and along Lot 8 and said land of Draper northeasterly of Black Brook, a distance of 336.15 feet to a 5/8 inch iron rebar found firm and plumb with cap "RLS 1310";

Thence South 63°06'11" East by and along Lot 8 and said land of Draper northeasterly of Black Brook, a distance of 335.80 feet to a 5/8 inch iron rebar found firm and plumb with cap "RLS 1310";

Thence South 36°18'12" East by and along Lot 8 and said land of Draper northeasterly of Black Brook, a distance of 202.61 feet to a 5/8 inch iron rebar found firm and plumb with cap "RLS 1310";

Thence South 11°09'50" West by and along Lot 8 and said land of Draper northeasterly of Black Brook, a distance of 334.14 feet to a 5/8 inch iron rebar found firm and plumb with cap "RLS 1310";

Thence South 73°39'21" East by and along Lot 8 and said land of Draper northeasterly of Black Brook, a distance of 347.83 feet to the corner of Lots 7 and 8 as shown on said Plan of Area XIII and witnessed by a 5/8 inch iron rebar found firm and leaning with cap "RLS 1310";

Thence South 15°58'16" West by and along Lot 7 and said land of Draper, crossing Black Brook, and continuing on the same course by and along Lot 3 of said Plan and said land of Draper, a total distance of 177.03 feet to a 5/8 inch iron rebar found firm and plumb with cap "RLS 1310";

Thence North 73°50'05" West by and along Lot 3 and said land of Draper southwesterly of Black Brook, a distance of 386.91 feet to the corner of Lots 2 and 3 as shown on said Plan of Area XIII, witnessed by a 5/8 inch iron rebar found firm and plumb with cap "RLS 1310";

Thence North 41°55'15" West by and along Lot 2 as and said land of Draper southwesterly of Black Brook, a distance of 249.45 feet to a 5/8 inch iron rebar found firm and plumb 1 inch above grade with cap "RLS 1310";

Thence North 07°10'52" East by and along Lot 2 and said land of Draper southwesterly of Black Brook, a distance of 275.77 feet to a 5/8 inch iron rebar found firm and plumb 1 inch above grade with cap "RLS 1310";

Thence North 67°11'32" West by and along Lot 2 and said land of Draper southwesterly of Black Brook, a distance of 311.22 feet to a 5/8 inch iron rebar found firm and plumb with cap "RLS 1310";

Thence North 45°54'24" West by and along Lot 2 and said land of Draper southwesterly of Black Brook, a distance of 647.13 feet to a 5/8 inch iron rebar found firm and plumb 1 inch above grade;

Thence South 55°46'30" West by and along Lot 2 and said land of Draper a distance of 414.81 feet to a 5/8 inch iron rebar found firm and plumb 1 inch above grade;

Thence South 28°54'35" West by and along Lot 2 and said land of Draper a distance of 865.99 feet to a 5/8 inch iron rebar found firm and plumb 15 inches above grade;

Thence South 40°57'13" West by and along Lot 2 and said land of Draper a distance of 664.73 feet to the corner of Lots 1 and 2 as shown on said Plan of Area XIII, witnessed by a 5/8 inch iron rebar found flush with the ground;

Thence North 67°59'55" West by and along Lot 1 and said land of Draper a distance of 569.12 feet to a 5/8 inch iron rebar found firm and plumb 3 inches above grade;

Thence South $71^{\circ}22'32''$ West by and along Lot 1 and said land of Draper a distance of 307.86 feet to a $5/8$ inch iron rebar found firm and plumb 3 inches above grade;

Thence South $41^{\circ}40'49''$ West by and along Lot 1 and said land of Draper a distance of 445.38 feet to a $5/8$ inch iron rebar found firm and plumb 3 inches above grade;

Thence South $16^{\circ}36'49''$ East by and along Lot 1 and said land of Draper a distance of 563.08 feet to a $5/8$ inch iron rebar found firm and plumb 3 inches above grade;

Thence South $17^{\circ}26'50''$ West by and along Lot 1 and said land of Draper a distance of 391.94 feet to a $5/8$ inch iron rebar found firm and plumb 3 inches above grade;

Thence North $88^{\circ}23'08''$ East by and along Lot 1 and said land of Draper a distance of 388.30 feet to a $5/8$ inch iron rebar found firm and plumb 4 inches above grade with cap "RLS 1310";

Thence South $12^{\circ}29'59''$ West by and along Lot 1 and said land of Draper a distance of 249.46 feet to a $5/8$ inch iron rebar found firm and plumb 2 inches above grade with cap "RLS 1310";

Thence South $75^{\circ}29'25''$ West by and along Lot 1 and said land of Draper a distance of 165.64 feet to a $5/8$ inch iron rebar found firm and plumb 4 inches above grade with cap "RLS 1310";

Thence South $26^{\circ}38'18''$ West by and along Lot 1 and said land of Draper a distance of 337.21 feet to the corner of Lot 1 and shown on said Plan of Area XIII and the northwesterly corner of Lot 21 as shown on the plan titled "Survey Plan Land of TM-Corporation Area XII" dated March 29, 1989, prepared by Terrence S. Worcester and recorded at the SCRD in Plan File B-89, Page 45, said corner being witnessed by a $5/8$ inch iron rebar found firm and plumb 4 inches above grade with cap "RLS 1310";

Thence South $25^{\circ}26'56''$ West by and along Lot 21 as shown on said Plan of Area XII and said land of Draper a distance of 700.21 feet to the corner of Lots 21 and 20 as shown on said Plan of Area XII, witnessed by a $5/8$ inch iron rebar found firm and plumb 2 inches above grade with cap "RLS 1310";

Thence South $25^{\circ}22'54''$ West by and along Lot 20 and said land of Draper a distance of 230.24 feet to a $5/8$ inch iron rebar found firm and plumb 3 inches above grade with cap "RLS 1310";

Thence South $44^{\circ}18'50''$ West by and along Lot 20 and said land of Draper a distance of 478.71 feet to the corner of Lots 20 and 17 as shown on said Plan of Area XII, witnessed by a $5/8$ inch iron rebar found firm and plumb 3 inches above grade with cap "RLS 1310";

Thence South $44^{\circ}19'29''$ West by and along Lot and said land of Draper a distance of 478.09 feet to the corner of Lots 16 and 17 as shown on said Plan of Area XII, witnessed by an iron rebar found firm and plumb 2 inches above grade;

Thence South $44^{\circ}18'36''$ West by and along Lot 16 and said land of Draper a distance of 287.73 feet to an iron rebar found firm and plumb 2 inches above grade;

Thence South $57^{\circ}59'02''$ West by and along Lot 16 and said land of Draper a distance of 584.86 feet to an iron rebar found firm and plumb 2 inches above grade;

Thence South 78°56'29" West by and along Lot 16 and said land of Draper a distance of 495.07 feet to an iron rebar found firm and plumb 2 inches above grade in a ring of stones;

Thence South 54°09'20" West by and along Lots 16 and 15 and said land of Draper a total distance of 456.14 feet to a 5/8 inch iron rebar found firm and plumb 2 inches above grade in a ring of stones;

Thence South 28°17'10" East by and along Lots 15 and 11 and said land of Draper a total distance of 1602.48 feet to an iron rebar found 1 inch below grade in a wet area;

Thence South 14°28'25" East by and along Lots 11 and 10 and said land of Draper a total distance of 446.23 feet to an iron rebar found firm and plumb 2 inches above grade in a ring of stones;

Thence South 04°42'08" East by and along Lots 10 and 9 and said land of Draper a total distance of 423.67 feet to an iron rebar found firm and plumb 2 inches above grade;

Thence South 20°15'45" West by and along Lot 9 and said land of Draper a distance of 609.70 feet to the corner of Lots 9 and 5 as shown on said Plan of Area XII, witnessed by a 5/8 inch iron rebar found with cap "RLS 1310";

Thence South 20°20'55" West by and along Lot 5 and said land of Draper a distance of 62.24 feet to a 5/8 inch iron rebar found with cap "RLS 1310";

Thence South 37°29'41" West by and along Lot 5 and said land of Draper a distance of 605.94 feet to an iron rebar found firm and plumb 2 inches above grade;

Thence South 34°37'00" East by and along Lot 5 and said land of Draper a distance of 129.14 feet to the corner of Lots 5 and 4 as shown on said Plan of Area XII and witnessed by an iron rebar found 2 inches high in ledge;

Thence continuing South 34°37'00" East by and along Lot 4 and said land of Draper a distance of 91.99 feet to an iron rebar found 1 inch below grade;

Thence South 56°56'36" East by and along Lot 4 and said land of Draper a distance of 837.23 feet to a 5/8 inch iron rebar found with cap "RLS 1310";

Thence South 53°13'11" East by and along Lot 4 and said land of Draper a distance of 413.85 feet to a 5/8 inch iron rebar found with cap "RLS 1310";

Thence South 25°18'32" West by and along Lot 4 and said land of Draper a distance of 94.09 feet to the southwest corner of Lot 4 as shown on said Plan of Area XII and the northwest corner of Lot 23 as shown on the plan titled "Survey Plan Land of TM-Corporation Area XI" dated March 27, 1989, prepared by Terrence S. Worcester and recorded at the SCRD in Plan File B-89, Page 25, said corner being witnessed by a 5/8 inch iron rebar found with cap "RLS 1310";

Thence South 35°16'29" East by and along Lot 23 as shown on said Plan of Area XI and said land of Draper a distance of 359.93 feet to a 5/8 inch iron rebar found with cap "RLS 1310";

Thence South 00°35'02" East by and along Lot 23 and said land of Draper a distance of 582.98 feet to the corner of Lots 23 and 22 as shown on said Plan of Area XI, witnessed by a 5/8 inch iron rebar found with cap "RLS 1310";

Thence South 10°31'49" West by and along Lot 22 and land now or formerly of Gordon C. Berry by deed recorded at said SCRD in Book 1778, Page 291 a distance of 530.04 feet to an iron rebar found flush with the ground with cap "RLS 1310";

Thence South 09°45'31" East by and along Lot 22 and said land of Berry a distance of 311.18 feet to an iron rebar found firm and plumb 2 inches above grade with cap "RLS 1310";

Thence North 87°52'45" East by and along Lot 22 and said land of Berry a distance of 193.73 feet to an iron rebar found firm and plumb 24 inches above grade with cap "RLS 1310";

Thence South 06°10'44" East by and along Lot 22 and said land of Berry a distance of 381.61 feet to an iron rebar found firm and plumb 10 inches above grade with cap "RLS 1310";

Thence South 33°18'16" East by and along Lot 22 and said land of Berry a distance of 502.74 feet to an iron rebar found firm and plumb 2 inches above grade with cap "RLS 1310";

Thence South 45°31'02" West by and along Lot 22 and said land of Berry a distance of 73.32 feet to an iron rebar found firm and plumb 2 inches above grade with cap "RLS 1310";

Thence North 63°21'34" West by and along Lot 22 and said land of Berry a distance of 302.93 feet to an iron rebar found firm and plumb 2 inches above grade with cap "RLS 1310";

Thence South 51°57'47" West by and along Lot 22 and said land of Berry a distance of 669.12 feet to an iron rebar found firm and plumb 4 inches above grade with no cap;

Thence South 35°52'08" West by and along Lot 22 and said land of Berry a distance of 237.93 feet to the corner of Lots 22 and 21 on said Plan of Area XI and to the northwesterly corner of land now or formerly of Arthur E. Wilder, Sara I. Wilder, and Elizabeth I. Wilder by deed recorded at said SCRD in Book 1785, Page 209, said corner being witnessed by an iron rebar found firm and plumb 4 inches above grade with cap "RLS 1310";

Thence South 09°48'28" West by and along Lot 21 and said land of Wilder a distance of 443.47 feet to the base of an iron rebar found 4 inches above grade, loose and leaning with no cap;

Thence South 03°26'00" East by and along Lot 21 and said land of Wilder a distance of 315.39 feet to an iron rebar found firm and plumb 4 inches above grade with no cap;

Thence South 30°29'42" West by and along Lot 21 and said land of Wilder a distance of 511.55 feet to the corner of Lots 21 and 20 as shown on said Plan of Area XI and to the northerly corner of land now or formerly of Arthur E. Wilder and Sarah I. Wilder by deeds recorded at the SCRD in Book 2496, Page 24 and Book 2888, Page 26, said corner being witnessed by an iron rebar found firm and plumb 4 inches above grade with cap "RLS 1310";

Thence South 43°09'00" West by and along Lot 20 and said land of Wilder a distance of 445.10 feet to an iron rebar found firm and plumb 4 inches above grade with no cap;

Thence South 58°23'28" West by and along Lot 20 and said land of Wilder a distance of 386.35 feet to the corner of Lots 20 and 19 as shown on said Plan of Area XI and a 5/8 inch iron rebar found firm and plumb 4 inches above grade with cap "RLS 1310";

Thence South 68°44'27" West by and along Lot 19 and said lands of Wilder a distance of 185.11 feet to a 5/8 inch iron rebar found firm and plumb with cap "RLS 1310";

Thence South 46°26'03" West by and along Lot 19 and said land of Wilder a distance of 783.57 feet to an iron rebar found firm and plumb 2 inches above grade;

Thence South 32°24'31" West by and along Lot 19 and said land of Wilder a distance of 764.47 feet to land being retained by the Grantor and witnessed by an iron rebar painted red found firm and plumb in a ring of stones;

Thence North 52°16'13" West by and along said land being retained by the Grantor a distance of 910 feet, more or less, to the thread of the Kennebec River, being South 52°16'13" East by and along said land being retained by the Grantor a distance of 690 feet, more or less, from an iron rebar with cap "SGC ENG PLS 2147" set on the contour line at elevation 820 feet based on NAVD88 datum, next to a wooden post found lying on ground in West Forks Plantation;

Thence Northerly along the thread of said Kennebec River and West Forks Plantation a distance of 7.3 miles, more or less, to the point of beginning.

Meaning and intending to convey all land westerly of the TM-Corporation Subdivision, northerly of a 336.6 foot wide corridor being retained by the Grantor and to the thread of the Kennebec River within the above described Township, containing 526.4 acres, more or less.

Bearings and distances are based on Grid North, NAD 83, UTM Zone 19.

Parcel 7

Moxie Gore Southerly Section East of Lost Camp Road

Beginning at a 5/8 inch iron rebar set with cap "SGC ENG PLS #2147" at the most easterly corner of land being retained by the Grantor containing 4.5 acres and on the southwesterly bound of other land being retained by the Grantor upon which a camp is located, known as "Lost Camp", the camp being occupied by Gordon Berry under a letter of agreement prepared by Central Maine Power Company dated August 10, 2001 and signed by them September 10, 2001, said rebar being South 52°16'13" East along said other retained land and across the Kennebec River a distance of 1881.07 feet, more or less, from the point of beginning for Parcel 5 herein described on the southeasterly bound of land now or formerly owned by Plum Creek Timberlands, LLC established by an exchange of deeds by and between S.D. Warren Company and Central Maine Power Company recorded at SCRD in Book 1416, Pages 120 and 127, reference being made to an Amended Application for Authority to do Business recorded in Book 2605, Page 152 for a change of name from SDW Timber II, LLC to Plum Creek Maine Timberlands, LLC;

Thence South 52°16'13" East passing through land of the Grantor along said other land being retained by the Grantor a distance of 500 feet to an iron rebar with red cap found firm and plumb at the northwesterly corner of land now or formerly owned by Arthur E. and Sara I. Wilder by deed recorded at SCRD in Book 2521, Page 22, shown as Lot 18 on a plan entitled, "Survey Plan Land of TM-Corporation Area XI, Parcels 1 - 24" dated March 27, 1989, prepared by Terrence S. Worcester and recorded at the SCRD in Plan File B-89. Page 25;

Thence South $36^{\circ}25'40''$ East along Lot 18 and said land of Wilder a distance of 243.11 feet to a 5/8 inch iron rebar with cap "RLS 1310" found firm and plumb;

Thence South $58^{\circ}50'44''$ West along Lot 18 and said land of Wilder a distance of 1007.01 feet to a 5/8 inch iron rebar with cap "RLS 1310" found firm and plumb;

Thence South $24^{\circ}20'22''$ East along Lot 18 and said land of Wilder a distance of 735.21 feet to a 5/8 inch iron rebar with cap "RLS 1310" found firm and plumb;

Thence South $38^{\circ}20'18''$ West along Lot 18 and said land of Wilder a distance of 332.32 feet to the base of a 6x6 cut wooden post found leaning and witnessed by a blazed tree, said post marking the northwesterly corner of land now or formerly owned by the State of Maine by deed recorded at SCRD in Book 878, Page 928;

Thence in a general southerly direction along a course situated 1000 feet easterly from the high water mark of the Kennebec River a distance of 1,950 feet, more or less, to the northeasterly side of a 100 foot wide strip of land retained by the Grantor, being near the end of a proposed road, the centerline being as depicted on a plan entitled, "Plan of Highway from Moxie Road to Site "F" East Branch of Kennebec River" filed by Fidelity Trust Co., Trustee, dated December 20, 1919 and recorded as Plan No. 18 in the Somerset County Registry of Deeds, as revised September 15, 1920 as Plan No. 18A and also shown on a plan of lands of the State of Maine dated December 21, 1981 and recorded in Plan File 2011, Page 46 in the SCRD (the "BPL Land Plan"), said point being on a tie line bearing of South $20^{\circ}42'21''$ West and distance of 1937.14 feet from the last described wooden post (Note: this course is shown on the Plan as a broken line rather than the solid Locus Boundary Line used for the remaining courses of the description);

Thence North $26^{\circ}27'57''$ West along said 100 foot wide strip, within which is located an existing gravel road leading to the "Lost Camp" so called, a distance of 147 feet, more or less, to a point on a spotted line surveyed by Hutchinson and Colby as noted on said plan dated in 1919, near the base of a 1" iron rebar 18 inches high and leaning, painted yellow and in stones;

Thence continuing North $26^{\circ}27'57''$ West along a 100 foot wide strip being retained by the Grantor running westerly and northerly across Moxie Stream to the "Lost Camp", so called, a distance of 24.38 feet to an angle point;

Thence North $64^{\circ}59'02''$ West along said 100 foot wide strip a distance of 373.20 feet to an angle point;

Thence North $04^{\circ}22'56''$ West along said 100 foot wide strip a distance of 234.51 feet to an angle point;

Thence North $39^{\circ}53'05''$ East along said 100 foot wide strip a distance of 549.20 feet to an angle point;

Thence North $30^{\circ}46'00''$ East along said 100 foot wide strip a distance of 459.39 feet to an angle point;

Thence North $18^{\circ}34'47''$ West along said 100 foot wide strip a distance of 498.94 feet to an angle point;

Thence North $59^{\circ}21'30''$ West along said 100 foot wide strip a distance of 385.55 feet to an angle point;

Thence North 20°37'41" East along said 100 foot wide strip a distance of 233.95 feet to an angle point;

Thence North 61°06'31" East along said 100 foot wide strip a distance of 185.38 feet to an angle point;

Thence North 23°02'24" East along said 100 foot wide strip a distance of 1029.33 feet to an angle point;

Thence North 59°05'26" East along said 100 foot wide strip a distance of 112.18 feet to an angle point;

Thence North 41°56'53" East along said 100 foot wide strip a distance of 301.27 feet to the southwesterly bound of a 4.5 acre parcel being retained by Central Maine Power, Company;

Thence South 52°16'13" East along said retained parcel a distance of 117.11 feet to a point at the southerly corner of said retained parcel;

Thence North 37°43'47" East along said retained parcel a distance of 340 feet to a point at the easterly corner of said retained parcel and the point of beginning.

Meaning and intending to convey all land westerly of the TM-Corporation Subdivision and land owned by the State of Maine, north and east of a 100 foot wide strip of land being retained as the "Lost Camp Road" and south of a 4.5 acre parcel and 336.6 foot wide corridor being retained by the Grantor, the above described parcel containing 56.2 acres, more or less.

Bearings and distances are based on Grid North, NAD 83, UTM Zone 19.

PARCEL 8

MOXIE GORE SOUTHERLY SECTION WEST OF LOST CAMP ROAD

Beginning at a point where the southwesterly bound of a 4.5 acre parcel of land being retained by the Grantor intersects the westerly bound of a 100 foot wide strip of land, known as the Lost Camp Road situated on a tie bearing of South 70°19'22" West through said parcel 403.55 feet from the point of beginning for Parcel 7 described above;

Thence South 41°56'53" West along said 100 foot wide strip a distance of 278.82 feet to an angle point;

Thence South 59°05'26" West along said 100 foot wide strip a distance of 129.65 feet to an angle point;

Thence South 23°02'24" West along said 100 foot wide strip a distance of 1027.37 feet to an angle point;

Thence South 61°06'31" West along said 100 foot wide strip a distance of 187.75 feet to an angle point;

Thence South 20°37'41" West along said 100 foot wide strip a distance of 354.71 feet to an angle point;

Thence South 59°21'30" East along said 100 foot wide strip a distance of 432.27 feet to an angle point;

Thence South 18°34'47" East along said 100 foot wide strip a distance of 415.83 feet to an angle point;

Thence South $30^{\circ}46'00''$ West along said 100 foot wide strip a distance of 405.48 feet to an angle point;

Thence South $39^{\circ}53'05''$ West along said 100 foot wide strip a distance of 581.90 feet to an angle point;

Thence South $04^{\circ}22'56''$ East along said 100 foot wide strip a distance of 333.62 feet to an angle point;

Thence South $64^{\circ}59'02''$ East along said 100 foot wide strip a distance of 396.70 feet to an angle point;

Thence South $26^{\circ}27'57''$ East along said 100 foot wide strip a distance of 50.55 feet to a point near a 1 inch iron rebar, 30 inches high, painted yellow in stones marking a line of spotted trees first marked by Hutchinson and Colby at the end of a 100 foot wide strip for a proposed road, the centerline being as depicted on a plan entitled, "Plan of Highway from Moxie Road to Site "F" East Branch of Kennebec River" filed by Fidelity Trust Co., Trustee, dated December 20, 1919 and recorded as Plan No. 18 in the Somerset County Registry of Deeds, as revised September 15, 1920 as Plan No. 18A and also shown on the BPL Land Plan;

Thence continuing South $26^{\circ}27'57''$ East along said 100 foot wide strip a distance of 143 feet, more or less, to a point situated 1000 feet easterly from the high water mark of the Kennebec River;

Thence southwesterly and turning southerly along a course situated 1000 feet easterly from the high water mark of the Kennebec River a distance of 1,667 feet, more or less, to a point on a line bearing South $82^{\circ}29'24''$ West along the northerly bound of other land owned by the State of Maine, known as the "Public Lot", approximately 120 feet from a stone pile, painted orange, found at an intersection of blazed lines and being North $82^{\circ}29'54''$ East along said other land of the State of Maine a distance of 1,266 feet, more or less, from an iron rebar with yellow cap found 14 inches above grade at or near the high water mark of the Kennebec River (Note: this course is shown on the Plan as a broken line rather than the solid Locus Boundary Line used for the remaining courses of the description);

Thence South $82^{\circ}29'54''$ West along said other land of the State of Maine a distance of 1266 feet, more or less, to an iron rebar with yellow cap found 14 inches high at or near the high water mark of the Kennebec River;

Thence continuing South $82^{\circ}29'54''$ West along said other land of the State of Maine a distance of 106 feet, more or less to the thread of the Kennebec River;

Thence in a northerly course along the thread of the Kennebec River and other land of the Grantor situated in West Forks Plantation a distance of 7,528 feet, more or less to a point on the southwesterly bound of land being retained by Central Maine Power Company and containing 4.5 acres, said point being North $17^{\circ}50'25''$ East, 5773.40 feet from the last described rebar;

Thence South $52^{\circ}16'13''$ East along said retained land a distance of 421.7 feet, more or less, to the point of beginning.

Meaning and intending to convey all land in Moxie Gore westerly of a 100 foot wide strip of land known as Lost Camp Road and land owned by the State of Maine north of the "Public Lot"

so called, and south of 4.5 acre parcel being retained by the Grantor, and to the thread of the Kennebec River, containing 127.9 acres, more or less.

Together with any right, title and interest the Grantor may have in those areas situated easterly of an offset line 1000 feet easterly of the high water mark of the Kennebec River and westerly of lands now owned by the State of Maine as described in said deed recorded at SCRD in Book 878, Page 928 and shown as Lot 1.2 on Moxie Gore Tax Map 1, any area contained within being already accounted for in the total acreage cited above.

Bearings and distances are based on Grid North, NAD 83, UTM Zone 19

Grantor acquired its interest in the above described Parcels from W. S. Wyman, et al. in a deed dated September 19, 1935 and recorded in the Somerset County Registry of Deeds in Book 434, Page 89, from Bessemer Securities Corporation in a deed dated May 15, 1951 and recorded in said Registry in Book 536, Page 131, from Edward C. Park, Executor of Henry Harriman, in a deed dated May 18, 1951 and recorded in said Registry in Book 536, Page 138, from Realty Operators Corporation in a deed dated May 14, 1951 and recorded in said Registry in Book 536, Page 135, from Gordon D. Harriman in a deed dated May 16, 1951 and recorded in said Registry in Book 536, Page 141, from Viles Timberlands, Inc. in a deed dated June 27, 1951 and recorded in said Registry in Book 536, Page 409, from Jennie E. Bigelow, et al. in a deed dated July 14, 1951 and recorded in said Registry in Book 536, Page 465, from S.D. Warren Company by a deed dated March 18, 1988, recorded in said Registry in Book 1416, Page 127, from T-M Corporation by deed dated March 22, 1989 and recorded in said registry in Book 1506, Page 288, from J.M. Huber Corporation by a deed dated July 17, 1993 and recorded in said Registry in Book 1932, Page 248, and from Plum Creek Maine Timberlands, L.L.C. by a boundary line agreement dated April 22, 2008 and recorded in said Registry in Book 3993, Page 14. This conveyance contains a total of 1482.8 acres, more or less.

Exhibit A-2 Appurtenant Easements

APPURTENANT EASEMENTS

WEST FORKS PLANTATION

ACROSS RETAINED LAND OF CENTRAL MAINE POWER COMPANY

Also hereby conveying, for the benefit of the above described lands located in West Forks Plantation, the following rights and easements, in common with others, over, under and across other land of the Grantor acquired in deeds from Viles Timberlands, Inc. to Central Maine Power Company dated June 27, 1951 and recorded in said Registry in Book 536, Page 409 and Jennie E. Bigelow, et al. to Central Maine Power Company dated July 14, 1951 and recorded in said Registry in Book 536, Page 465 (together "Grantor's Viles-Durgin Lot"), said Grantor's Viles-Durgin Lot being located in West Forks Plantation northeasterly of and adjacent to US Route 201 and southwesterly of and adjacent to Parcel 5, described above, said easements being more particularly described as follows:

Easement A – The perpetual right and easement to construct, maintain, repair, replace or remove roads, driveways and recreational trails and to place utilities of all kinds over, under and across a strip of land fifty feet in width described as follows:

Beginning on a point on the northeasterly side of US Route 201, as shown on State of Maine Department of Transportation Right of Way Map, State Highway "33", The Forks Plt. – West Forks Plt., Somerset County, dated March 1987, D.O.T. File No. 13-268 and also on Maine State Highway Commission Right of Way Map, State Highway "267", West Forks, Somerset County, dated January 1955, S.H.C. File No. 13-78, Sheet 9 of 9, said point being S 34° 26' 49" E a distance of 128.27 feet along the northeasterly line of said US Route 201 from a 5/8" rebar with SGC Engineering cap # 2147 marking the southerly corner of land now or formerly of The Church of Christ of The Forks as described in a deed recorded in said Registry in Book 232, Page 5, and a 5/8" rebar with SGC Engineering cap #2147;

Thence N 52° 05' 11" E across Grantor's Viles-Durgin Lot a distance of 102.77 feet to a point;

Thence N 53° 56' 04" W across Grantor's Viles-Durgin Lot a distance of 97.92 feet to a point;

Thence N 15° 13' 02" E across Grantor's Viles-Durgin Lot a distance of 133.93 to a point on the southwesterly line of land now or formerly of Gordon C. Berry as described in deeds recorded in said Registry in Book 1114, Page 342 and Book 1758, Page 7;

Thence N 58° 34' 06" E along land of said Berry a distance of 72.84 feet to a point;

Thence S 15° 13' 02" W across Grantor's Viles-Durgin Lot a distance of 152.43 to a point;

Thence S 53° 56' 04" E across Grantor's Viles-Durgin Lot a distance of 79.60 feet to a point;

Thence N 54° 45' 26" E across Grantor's Viles-Durgin Lot a distance of 140.32 feet to point;

Thence N 62° 58' 04" E across Grantor's Viles-Durgin Lot a distance of 73.53 feet to the southwesterly line of Easement B, described below;

Thence S 25° 19' 40" E across Grantor's Viles-Durgin Lot a distance of 50.02 feet to a point;

Thence S 62° 58' 04" W across Grantor's Viles-Durgin Lot a distance of 68.45 feet to a point;

Thence S 54° 45' 26" W across Grantor's Viles-Durgin Lot a distance of 158.45 feet to a point;

Thence S 26° 19' 07" E across Grantor's Viles-Durgin Lot a distance of 50.52 feet to a point;

Thence S 73° 01' 29" E across Grantor's Viles-Durgin Lot a distance of 217.66 feet to a point;

Thence S 36° 46' 10" E across Grantor's Viles-Durgin Lot a distance of 316.64 feet to an iron rebar at a corner a parcel of land conveyed by the Grantor to FPL Energy Maine Hydro LLC dated March 25, 2009 and recorded in said Registry in Book 4117, Page 248 (the "FPL Lot");

Thence S 36° 46' 10" E along said FPL Lot a distance of 120 feet to an iron rebar at a corner of said FPL Lot on the northwesterly line of Easement 1, described below;

Thence S 44° 24' 18" W along said FPL Lot a distance of 50.60 feet to point;

Thence N 36° 46' 10" W across Grantor's Viles-Durgin Lot a distance of 427.20 feet to a point;

Thence N 73° 01' 29" W across Grantor's Viles-Durgin Lot a distance of 222.88 feet to a point;

Thence N 26° 19' 07" W across Grantor's Viles-Durgin Lot a distance of 62.51 feet to a point;

Thence S 52° 05' 11" W across Grantor's Viles-Durgin Lot a distance of 83.38 feet to a point on the northeasterly line of said US Route 201;

Thence N 34° 26' 49" W along said US Route 201 a distance of 50.09 feet to the point of beginning.

The area of Easement A crosses a portion of a waterline easement reserved in a deed from Jennie E. Bigelow, Katherine M. Donahue, Rilla B. Quimby, Alton B. Durgin, Ruth M. Durgin, Helen Erdine Durgin Colgate and June Doreen Durgin Plasse to Central Maine Power Company dated July 14, 1951 and recorded in said Registry in Book 536, Page 465 and the exercise of the Easement A rights are subject to the prior rights of said waterline easement.

Easement B – The perpetual right and easement to construct, maintain, repair, replace or remove roads, driveways and recreational trails and to place utilities of all kinds over, under and across a strip of land one hundred feet in width described as follows:

Beginning at a point on the northwesterly line of Grantor's Viles-Durgin Lot and the southeasterly line of Parcel 5, described above, said point being S 64° 36' 22" E a distance of 132.78 feet from a 4"x4" wooden post marking the corner of said Parcel 5; thence

S 64° 36' 22" E along said Parcel 5 a distance of 105.50 feet to a point;

Thence S 43° 58' 39" W across Grantor's Viles-Durgin Lot a distance of 402.19 feet to a point;

Thence S 20° 38' 05" W across Grantor's Viles-Durgin Lot a distance of 76.70 feet to a point;

Thence S 34° 55' 19" W across Grantor's Viles-Durgin Lot a distance of 332.18 feet to a point;

Thence S 63° 37' 26" W across Grantor's Viles-Durgin Lot a distance of 204.31 feet to a point;

Thence S 79° 45' 31" W across Grantor's Viles-Durgin Lot a distance of 127.21 feet to a point;

Thence S 28° 19' 27" W across Grantor's Viles-Durgin Lot a distance of 181.12 feet to a point;

Thence S 62° 58' 04" W across Grantor's Viles-Durgin Lot a distance of 137.49 feet to a point;

Thence N 25° 19' 40" W across Grantor's Viles-Durgin Lot and the northeasterly end of Easement A, described above, a distance of 100.4 feet to a point that is S 25° 19' 40" E a distance of 150.48 feet from a 1 inch rebar found 2 feet above grade, loose and painted yellow, at the easterly corner of land of said Berry;

Thence N 62° 58' 04" E across Grantor's Viles-Durgin Lot a distance of 103.33 feet to a point;

Thence N 28° 19' 27" E across Grantor's Viles-Durgin Lot a distance of 198.09 feet to a point;

Thence N 79° 45' 31" E across Grantor's Viles-Durgin Lot a distance of 161.20 feet to a point;

Thence N 63° 37' 26" E across Grantor's Viles-Durgin Lot a distance of 164.55 feet to a point;

Thence N 34° 55' 19" E across Grantor's Viles-Durgin Lot a distance of 294.07 feet to a point;

Thence N 20° 38' 05" E across Grantor's Viles-Durgin Lot a distance of 84.83 feet to a point;

Thence N 43° 58' 39" E across Grantor's Viles-Durgin Lot a distance of 389.22 feet to the point of beginning.

Easement C – The perpetual right and easement to construct, maintain, repair, replace or remove roads, driveways and recreational trails and to place utilities of all kinds over, under and across a strip of land one hundred feet in width described as follows:

Beginning at a point on the northwesterly line of Grantor's Viles-Durgin Lot and the southeasterly line of Parcel 5, described above, said point being S 64° 36' 22" E a distance of 48.38 feet from an old wooden post set in stones and painted yellow;

Thence S 64° 36' 22" E along said line a distance of 101.49 feet to a point at or near the high water mark of the East Branch of the Kennebec River;

Thence S 35° 12' 33" W across Grantor's Viles-Durgin Lot a distance of 613.99 feet to a point;

Thence S 44° 25' 12" W across Grantor's Viles-Durgin Lot a distance of 334.75 feet to a point;

Thence S 47° 43' 21" W across Grantor's Viles-Durgin Lot a distance of 448.34 feet to a point;

Thence N 87° 55' 30" W across Grantor's Viles-Durgin Lot a distance of 82.41 feet to the easterly line of said FPL Lot;

Thence N 02° 57' 27" E along said FPL Lot, passing through a 5/8 inch rebar found with plastic cap #2157, a distance of 100.01 feet to a point that is 10.60 feet southerly along said line from an iron rebar found;

Thence S 87° 55' 30" E across Grantor's Viles-Durgin Lot a distance of 40.88 feet to a point;

Thence N 47° 43' 21" E across Grantor's Viles-Durgin Lot a distance of 404.70 feet to a point;

Thence N 44° 25' 12" E across Grantor's Viles-Durgin Lot a distance of 323.81 feet to a point; thence

N 35° 12' 33" E across Grantor's Viles-Durgin Lot a distance of 588.64 feet to the point of beginning.

The area of Easement C includes the area of an easement benefiting the US Geological Survey, its successors and assigns, to maintain, repair replace and remove the existing monitoring station located along the shore of the East Branch of the Kennebec River a distance of 200 feet, more or less, southwesterly of the most easterly corner of the herein conveyed parcel, together with the right in common with others for ingress and egress at all times across Easement 1, Easement 2, Easement A and Easement C, all described herein. The exercise of the Easement C rights herein is subject to the prior rights of the US Geological Survey.

Easement D – The perpetual right and easement to construct, maintain, repair, replace or remove roads, driveways and recreational trails and to place utilities of all kinds over, under and across a strip of land fifty feet in width described as follows:

Beginning at a point on the northwesterly line of the Grantor's Viles-Durgin Lot and the southeasterly line of lands formerly of S.D. Warren Company and now of Plum Creek Timberlands, LLC as described in a deed recorded in said Registry in Book 2605, Page 151, said point being S 60° 55' 14" E a distance of 365.23 feet from a ring of stones with a wooden post lying on the ground marking the most northerly corner of the Grantor's Viles-Durgin Lot, said point also being N 60° 55' 14" W a distance of 365.47 feet along said line from a 4"x4" wooden post marking the corner of lands of said Plum Creek Timberlands, LLC; thence

S 60° 55' 14" E along said line a distance of 56.70 feet to a point;

Thence S 00° 56' 46" W across Grantor's Viles-Durgin Lot a distance of 66.49 feet to a point;

Thence S 20° 35' 53" E across Grantor's Viles-Durgin Lot a distance of 88.33 feet to a point;

Thence S 35° 13' 06" E across Grantor's Viles-Durgin Lot a distance of 85.37 feet to a point;

Thence S 56° 00' 54" E across Grantor's Viles-Durgin Lot a distance of 112.26 feet to a point;

Thence S 19° 08' 33" E across Grantor's Viles-Durgin Lot a distance of 73.65 feet to a point;

Thence S 00° 48' 12" W across Grantor's Viles-Durgin Lot a distance of 56.99 feet to a point that is on the northwesterly side of Easement B, described above;

Thence S 43° 58' 39" W across Grantor's Viles-Durgin Lot and the northwesterly side of said Easement B, a distance of 73.08 feet to a point;

Thence N 00° 48' 12" E across Grantor's Viles-Durgin Lot a distance of 101.49 feet to a point;

Thence N 19° 08' 33" W across Grantor's Viles-Durgin Lot a distance of 48.19 feet to a point;

Thence N 56° 00' 54" W across Grantor's Viles-Durgin Lot a distance of 104.76 feet to a point;

Thence N 35° 13' 06" W across Grantor's Viles-Durgin Lot a distance of 100.95 feet to a point;

Thence N 20° 35' 53" W across Grantor's Viles-Durgin Lot a distance of 104.25 feet to a point;

Thence N 00° 56' 46" E across Grantor's Viles-Durgin Lot a distance of 102.74 feet to the point of beginning.

Said Easement A, Easement B, Easement C and Easement D to benefit any lands conveyed herein or any lands Grantee, its successors and assigns, may acquire in the future that are contiguous with the ownership of the Grantor as of May 15, 2011. MDOC may, upon written request to Grantor, relocate all or parts of Easement A, Easement B, Easement C or Easement D provided such relocation does not materially impact Grantor's then current use of Grantor's Viles-Durgin Lot or the excepted rights of others, MDOC obtains all necessary permits and regulatory approvals at its sole expense, the relocation is at the sole cost of MDOC and MDOC prepares a corrective deed and survey of the agreed to relocated easement.

**WEST FORKS PLANTATION
ACROSS LAND OF OTHERS**

Also hereby conveying, for the benefit of the above-described lands located in West Forks Plantation, the non-exclusive right, in common with Grantor and others, to utilize two easements for ingress and egress as reserved by the Grantor in a deed to FLP Energy Maine Hydro LLC dated March 25, 2009 and recorded in said Registry in Book 4117, Page 248 (the "FPL Lot"), being more particularly described as follows:

Easement 1 – A fifty-foot wide easement beginning at an iron rebar found on the northeasterly line of said County Right of Way, described below, that is S 65° 18' 12" E a distance of 30.43 feet from the iron rebar found at the most southerly corner of land now or formerly of Albert Marinilli as described in a deed dated February 13, 2007 and recorded in said Registry in Book 3811, Page 304 and further described in a boundary line agreement between the Grantor and said Marinilli dated January 31, 2011 and recorded in said Registry in Book 4366, Page 45; thence

N 44° 24' 18" E along the FPL Lot a distance of 235.00 feet to an iron rebar found;

Thence S 36° 46' 10" E across the FPL Lot a distance of 50.60 feet to a point;

Thence S 44° 24' 18" W across the FPL Lot a distance of 254.20 feet to the northeasterly line of the County Right-of-Way Line as shown on plans titled "Maine State Highway Commission Plan of Proposed Relocation of State Highway "H", West Forks and The Forks", Somerset County, dated July 19, 1932, File # 13-9 and "Maine State Highway Commission Plan of Proposed Relocation of State Highway "H", West Forks and The Forks", Somerset County, dated June 1932, File # 23-7;

Thence N 65° 26' 21" W along said County Right of Way a distance of 53.16 feet to the point of beginning.

Easement 2 – A twenty-foot wide easement centered over the existing gravel way beginning at the northeasterly line of Easement 1, above, and extending northeasterly and easterly to the easterly line of the FPL Lot, a distance of 500 feet, more or less.

Easement 1 and Easement 2 to benefit the Grantee herein, in common with others, in connection with Easement A, Easement B, Easement C and Easement D, under the same terms and conditions as set forth in the above referenced conveyance to FPL Energy Maine Hydro LLC.

All bearings and distances used to describe Easement 1, Easement 2, Easement A, Easement B, Easement C and Easement D are based Grid North, NAD 83, UTM Zone 19.

Also hereby conveying for the benefit of Parcel 4 and Parcel 5, a non-exclusive right to utilize, in common with Grantor and others, certain rights-of-way between highway Route 201 and Parcel 4 and Parcel 5, over, along and across land formerly of S.D. Warren Company in West Forks Plantation, Chase Stream Township (T1, R6, BKP WKR) and Johnson Mountain Township (T2, R6, BKP WKR) under the same terms and conditions as set forth in a deed from S.D. Warren Company to Central Maine Power Company dated March 18, 1988, recorded in said Registry in Book 1416, Page 127.

MOXIE GORE

ACROSS RETAINED LAND OF CENTRAL MAINE POWER COMPANY

Also hereby conveying, for the benefit of Parcels 7 and Parcel 8, the following rights and easements, in common with others for access by foot and with vehicles, over, under and across other land of the Grantor acquired from W. S. Wyman, et al. in a deed dated September 19, 1935 and recorded in the Somerset County Registry of Deeds in Book 434, Page 89, from Bessemer Securities Corporation in a deed dated May 15, 1951 and recorded in said Registry in Book 536, Page 131, from Edward C. Park, Executor of Henry Harriman, in a deed dated May 18, 1951 and recorded in said Registry in Book 536, Page 138, from Realty Operators Corporation in a deed dated May 14, 1951 and recorded in said Registry in Book 536, Page 135, from Gordon D. Harriman in a deed dated May 16, 1951 and recorded in said Registry in Book 536, Page 141 and from T-M Corporation in a deed dated March 22, 1989 and recorded in said Registry in Book 1506, Page 288 (together "Lost Camp Road Parcel"), said Lost Camp Road Parcel being located in Moxie Gore T1 R5 BKP EKR northerly of and adjacent to the Lake Moxie Road and adjacent, in part, to Parcel 7 and Parcel 8, described above, said easement rights being the perpetual right and easement to construct, maintain, repair, replace or remove roads, driveways and recreational trails, including the right to cut and remove those trees and vegetation necessary for the foregoing, over, under and across the Lost Camp Road Parcel more particularly described as follows:

Beginning at a point in the northerly line of the Lake Moxie Road at the southwesterly corner of the Lost Camp Road Parcel and a southeast corner of land of the State of Maine as described in a deed recorded in said Registry in Book 878, Page 928 (the "State Deed");

Thence N 05°27'03"E along lands of the State of Maine a distance of 435.21 feet to a point;

Thence N 38°48'57" W along lands of the State of Maine a distance of 1223.85 feet to a point;

Thence N 45°01'57" W along lands of the State of Maine a distance of 360.41 feet to a point;

Thence N 66°29'57" W along lands of the State of Maine a distance of 1569.74 feet to a point;

Thence N 26°27'57" W along lands of the State of Maine a distance of 130 feet more or less to the southeasterly line of Parcel 8, described above;

Thence continuing on the same bearing along said Parcel 8 a distance of 143 feet, more or less to a 1 inch iron rebar, 30 inches high, painted yellow in stones marking a line of spotted trees first marked by Hutchinson and Colby at the end of a 100 foot wide strip for a proposed road, the centerline being as depicted on a plan entitled, "Plan of Highway from Moxie Road to Site "F" East Branch of Kennebec River" filed by Fidelity Trust Co., Trustee, dated December 20, 1919 and recorded as Plan No. 18 in the Somerset County Registry of Deeds, as revised September 15, 1920 as Plan No. 18A and also shown on the BPL Land Plan, said tangent having a length of 273.69 feet between the last angle point and said 1 inch iron rebar;

Thence continuing N 26°27'57" W along Parcel 8 a distance of 50.55 feet to a point;

Thence N 64°59'02" W along Parcel 8 a distance of 396.70 feet to a point;

Thence N 04°22'56" W along Parcel 8 a distance of 333.62 feet to a point;

Thence N 39°53'05" E along Parcel 8 a distance of 581.90 feet to a point;

Thence N 30°46'00" E along Parcel 8 and crossing Moxie Stream a distance of 405.48 feet to a point;

Thence N 18°34'47" W along Parcel 8 a distance of 415.83 feet to a point;

Thence N 59°21'30" W along Parcel 8 a distance of 432.27 feet to a point;

Thence N 20°37'41" E along Parcel 8 a distance of 354.71 feet to a point;

Thence N 61°06'31" E along Parcel 8 a distance of 187.75 feet to a point;

Thence N 23°02'24" E along Parcel 8 a distance of 1027.37 feet to a point;

Thence N 59°05'26" E along Parcel 8 a distance of 129.65 feet to a point;

Thence N 41°56'53" E along Parcel 8 a distance of 278.82 feet to other retained land of Central Maine Power Company;

Thence S 52°16'13" E along said other retained land a distance of 100.27 feet to a point being the westerly line of Parcel 7;

Thence S 41°56'53" W along Parcel 7 a distance of 301.27 feet to a point;

Thence S 59°05'26" W along Parcel 7 a distance of 112.18 feet to a point;

Thence S 23°02'24" W along Parcel 7 a distance of 1029.33 feet to a point;

Thence S 61°06'31" W along Parcel 7 a distance of 185.38 feet to a point;

Thence S 20°37'41" W along Parcel 7 a distance of 233.95 feet to a point;

Thence S 59°21'30" E along Parcel 7 a distance of 385.55 feet to a point;

Thence S 18°34'47" E along Parcel 7 a distance of 498.94 feet to a point;

Thence S 30°46'00" W along Parcel 7 and crossing Moxie Stream a distance of 459.39 feet to a point;

Thence S 39°53'05" W along Parcel 7 a distance of 549.20 feet to a point;

Thence S 04°22'56" E along Parcel 7 a distance of 234.51 feet to a point;

Thence S 64°59'02" E along Parcel 7 a distance of 373.20 feet to a point;

Thence S 26°27'57" E along Parcel 7 a distance of 24.38 feet to a 1 inch iron rebar, 18 inches high and leaning, painted yellow in stones marking a line of spotted trees first marked by Hutchinson and Colby at the end of a 100 foot wide strip for a proposed road, the centerline being as depicted on a plan entitled, "Plan of Highway from Moxie Road to Site "F" East Branch of Kennebec River" filed by Fidelity Trust Co., Trustee, dated December 20, 1919 and recorded as Plan No. 18 in the Somerset County Registry of Deeds, as revised September 15, 1920 as Plan No. 18A and also shown on the BPL Land Plan;

Thence continuing S 26°27'57" E along Parcel 7 a distance of 147 feet, more or less to the southeasterly line of Parcel 7;

Thence continuing on the same bearing along lands of the State of Maine a distance of 152 feet, more or less to a point, said tangent having a length of 298.38 feet between said iron rebar and this point;

Thence S 66°29'57" E along lands of the State of Maine a distance of 1552.26 feet to a point;

Thence S 45°01'57" E along lands of the State of Maine a distance of 384.79 feet to a point;

Thence S 38°48'57" E along lands of the State of Maine a distance of 1269.95 feet to a point;

Thence S 05°27'03" W along lands of the State of Maine a distance of 431.73 feet to the northerly line of the Lake Moxie Road;

Thence westerly along the northerly line of Lake Moxie Road a distance of 109 feet, more or less, to the point of beginning, said point being S 71°37'41" W a distance of 109.31 feet from the last mentioned point.

Said easement rights to include the right of MDOC to place a bridge, with the necessary abutments and wing walls, over Moxie Stream provided MDOC first obtain the written approval of its bridge design from the Grantor, said approval not to be unreasonably withheld. Grantor may, at Grantor's sole discretion, increase the size and/or carrying capacity of said bridge provided Grantor pay all incremental costs for such increased size and/or carrying capacity.

MDOC and Grantor shall maintain any road on the Lost Camp Road Parcel to the extent of their respective use. For the purpose of this paragraph, the use by the public shall be considered as use by MDOC.

MDOC may place a gate or gates on any road on the Lost Camp Road Parcel at such locations as MDOC determines in its sole discretion provided, however, that Grantor, its successors, assigns, agents or contractors shall have access through any such gate at all times by use of a dual lock system.

MOXIE GORE

ACROSS LAND OF OTHERS

Also hereby conveying, for the benefit of Parcel 6, Parcel 7 and Parcel 8, the non-exclusive right, in common with Grantor and others, to utilize certain roads and/or rights-of-way between the Harris Dam Road, so called, extending from Moxie Village to Harris Dam, and Parcel 6, Parcel 7, and Parcel 8, described above, certain rights to remove and use gravel and other earth materials and certain flowage rights appurtenant to Parcel 6, Parcel 7 and Parcel 8, over, along and across land formerly of T-M Corporation in Moxie Gore (T1, R5, BKP EKR), being the rights described in items 4, 5, 6 and 8 and under the same terms and conditions as set forth in a deed from T-M Corporation to Central Maine Power Company dated November 10, 1988 and recorded in said Registry in Book 1480, Page 89 together with the rights to utilize certain roads and/or rights-of-way extending between said Harris Dam Road and Parcel 6, Parcel 7 and Parcel 8 under the same terms and conditions as set forth in a deed from T-M Corporation to Central Maine Power Company dated November 6, 1989 and recorded in said Registry in Book 1573, Page 248.

Also hereby conveying the scenic easement benefiting Parcel 6 and Parcel 7, described above, described in a easement deed from T-M Corporation to Central Maine Power dated November 1, 1989 and recorded in said Registry in Book 1573, Page 250, said easement to prohibit any significant vegetation cutting on then-owned T-M Corporation lands within 125 feet of the common border of land of T-M Corporation and Central Maine Power Company as described in a deed from T-M Corporation to Central Maine Power Company dated March 22, 1989 and recorded in said Registry in Book 1506, Page 288, said easement rights to be effective after January 1, 1992 and the significance of the cutting to be determined by Central Maine Power Company in its sole discretion.

Exhibit B-1 Reservations and Exceptions

RESERVATIONS AND EXCEPTIONS

This conveyance is subject to the following rights and easements:

WEST FORKS PLANTATION

Reserving to the Grantor and its successors and assigns, the right to use existing roads and trails on the southern end of Parcel 4 and the northern end of Parcel 5, both described above, to periodically access with vehicles and equipment the retained land of the Grantor located between said Parcel 4 and Parcel 5 for purposes of the Grantor's business as a public utility.

Excepting from this conveyance a certain easement for a recreational trail to be granted to Western Mountains Charitable Foundation in an easement to be recorded in said Registry prior to Closing.

This conveyance is subject to a license for the use of certain lunch sites by commercial outfitters, said sites labeled "Northern Outdoors Lunch Site", "Windfall Rafting Lunch Site", "Magic Falls Lunch Site" and "Public Site Lunch Site", all as shown on the Plan, under the terms and conditions set forth in a license agreement between Central Maine Power Company and FPL Energy Maine Hydro LLC dated July 1999 (the "FPL License") a memorandum of which is recorded in said Registry in Book 4433, Page 325.

MOXIE GORE

Excepting from this conveyance the rights and easement to access the Kennebec River described in deeds from Central Maine Power Company to FPL Energy Maine Hydro LLC dated April 7, 1999 and recorded in said Registry in Book 2540, Page 24 and dated October 10, 2003 and recorded in said Registry in Book 3240, Page 295 (collectively the "Stairway Easement").

Reserving to the Grantor and its successors and assigns, the right and easement to cross on foot the conveyed lands in the Stairway Easement, described above, located between the retained land of Grantor described in a deed from T-M Corporation dated July 21, 1993 and recorded in said Registry in Book 1921, Page 327, and the Kennebec River.

This conveyance is subject to a license for the use of certain lunch sites by commercial outfitters, said sites labeled "Wilderness Rafting Lunch Site", "Crab Apple Lunch Site", "Downeast / Adventure Bound Lunch Site", "Unicorn Lunch Site", "Moxie Outdoor Adventure Lunch Site", "New England Whitewater Lunch Site", "Former Magic Falls Lunch Site" and "North Country Rivers Lunch Site", all as shown on the Plan, under the terms and conditions set forth in the FPL License.

INDIAN STREAM, SQUARETOWN & CHASE STREAM TOWNSHIPS

Reserving to the Grantor and its successors and assigns, the right and easement to place electric and communication transmission and distribution lines over or under Parcel 1, Parcel 2 and Parcel 3, from and to other lands of Grantor located in Indian Stream Township, Squaretown Township and Chase Stream Townships provided, however, that the placement of such electric

and communication lines does not necessitate the cutting or removal of vegetation or the placing of structures on or within said Parcel 1, Parcel 2 or Parcel 3.

Reserving to the Grantor and its successors and assigns, the right and easement to cross on foot any conveyed lands in Parcel 1, Parcel 2, and Parcel 3, described above, located between the retained land of Grantor and the Kennebec River.

ALL LANDS

Said Parcel 1, Parcel 2, Parcel 3, Parcel 4, Parcel 5, Parcel 6, Parcel 7 and Parcel 8 are subject to certain restrictive covenants described in a Declaration of Covenants and Restrictions pursuant to State of Maine Department of Environmental Protection Site Location of Development Act and Natural Resources Protection Act Orders, Project Number #L-24620-26-A-N/L-24620-TG-B-N/L-24620-VP-C-N/L-24620-IW-D-N/L-24620-L6-E-N and U.S. Army Corps of Engineers Permit Number NAE-2008-03017 to be recorded prior to Closing.

Attachment III



March 29, 2018

Mr. James R. Beyer
Maine Department of Environmental Protection
Division of Land Resources Regulation
106 Hogan Road
Bangor, ME 04401

**RE: Responses to Data Requests
New England Clean Energy Connect Project
Natural Resources Protection Act and Site Location of Development Act permit
applications**

Dear Mr. Beyer:

Central Maine Power Company (CMP) is pleased to provide responses to the Maine Department of Environmental Protection's (MDEP) November 20, 2017, and December 12, 2017, information requests associated with the Site Location of Development Act and Natural Resources Protection Act permit applications submitted by CMP on September 27, 2017, for the New England Clean Energy Connect (NECEC) project.

The attached document provides responses in two formats. The first provides responses to general questions included in the MDEP's information request. The second provides responses in tabular format to questions specific to the project natural resource maps included with the applications.

If you have any questions regarding these responses, please give me a call at (207) 626-9557 or email gerry.mirabile@cmpco.com.

Sincerely,

A handwritten signature in blue ink that reads "Gerry J. Mirabile".

Gerry J. Mirabile
Manager – Environmental Projects
Environmental Permitting
AVANGRID Networks, Inc.

Enclosures

cc: Samantha Horn, LUPC; Bill Hinkel, LUPC; Jay Clement, USACE; Christopher Lawrence, USDOE; Melissa Pauley, USDOE; Bernardo Escudero, CMP; Mark Goodwin, Burns & McDonnell; Matt Manahan, Pierce Atwood; Jared des Rosiers, Pierce Atwood
File: New England Clean Energy Connect



**Response to the
November 20, 2017, and December 12, 2017
MDEP Information Requests**

New England Clean Energy Connect (NECEC)



Prepared for:
Maine Department of Environmental Protection

March 29, 2018

ENVIRONMENTAL INFORMATION REQUEST
General Questions
November 20, 2017

- 1. Can the applicant use the entire ROW and move the line and structures to avoid wetland impacts? If the answer to the question above is no, then would the project result in fewer impacts if it was located entirely on the north side of the ROW?**

RESPONSE

CMP normally sites transmission lines and structures on one side of a corridor to retain the adjacent unobstructed corridor for future use. This practice also minimizes environmental impacts by reducing the need to locate future transmission lines in additional corridors by either expanding corridor or establishing new greenfield corridor.

Locating the line in an alternating fashion from one side of the corridor to the other to avoid certain natural resources (or to cross them at their narrowest points) would result in additional impacts due to an increase in the total number of structures required to construct the line, including more costly angle structures. These structures potentially require reinforced concrete foundations. Angle structures also require more space and clearing of low lying brush to install than single pole tangent structures. Shifting the transmission line within the corridor would also likely increase impacts from guy wire anchors, where angle structures require guying. Increasing the "footprint" of the line by installing numerous angle structures also increases the overall area of disturbed soils and the risk of erosion and sedimentation.

Aesthetics and visibility are also considered in locating transmission lines within a corridor. If future co-located transmission lines must cross over or under adjacent lines, structures must be considerably taller and larger than would otherwise be required, to maintain minimum safe conductor-to-ground clearances and conductor-to-conductor clearances.

CMP has utilized the considerable span length (averaging 1,000 feet) of the proposed HVDC transmission line to avoid or minimize direct fill impacts in protected natural resources within the corridor to the extent practicable, while maintaining reasonable structure heights to minimize visual impacts. While individual structure locations may change as design progresses, average span lengths between structures on the natural resource maps is unlikely to change significantly. CMP does not anticipate placing additional structures along the corridor or between those structures depicted in CMP's pending applications, but this will be confirmed as the design is finalized.

CMP conducted a preliminary comparative analysis of the greenfield portion of the NECEC project (Segment 1) to determine if shifting the transmission line to the north side of the ROW would result in fewer impacts to natural resources. For purposes of this comparison, access roads were not included in this analysis. This analysis considered direct wetland fill impacts (structures) conversion of forested wetlands (tree clearing).. The methodology for this analysis

was to shift the current alignment and structure locations to the northern side of the corridor. The south alignment as proposed directly impacts 0.024 acres, whereas the north alignment may impact approximately 0.022 acres. This results in a net change of -0.002 acres or -49 square feet or -4.83% in favor of the north alignment. For conversion of forested wetlands, the south alignment as proposed impacts approximately 72.48 acres, whereas the north alignment may impact approximately 77.05 acres. This results in a net change of +4.57 acres or +6.31% in favor of the south alignment. Based on these results, when comparing the south alignment (CMP's proposed option) to the north alignment, the difference in natural resource impacts is comparatively minor.

The preliminary comparative analysis described above did not include a detailed engineering review of the shifted alignment and structure locations and, as a result, direct impacts to resources on the northern alignment may not be optimized. To further refine the comparison and more accurately compare the southern alignment to the northern alignment, CMP is nearing completion on a 30% engineering design on the northern alignment. Once the engineering design work is complete (anticipated for late March), CMP will conduct an engineering feasibility and natural resource impact analysis and comparison, and will provide the results of that process to the MDEP. CMP will amend the application if a shift in alignment is warranted based on the results of this analysis.

2. The crossing of the Kennebec River at the gorge is over an Outstanding River Segment (38 M.R.S. § 480-P(8) and 12 M.R.S. § 403). The applicant will need to demonstrate that no reasonable alternative exists that would have less adverse effect upon the natural and recreational features of the river segment.

RESPONSE

Please see NRPA application Chapter 2: Alternatives, Section 2.4.1.2 and Site Law application Chapter 25, Section 25.3.1.2 for a detailed alternatives discussion for the Kennebec River Gorge. Those materials demonstrate that no reasonable alternative crossing location exists that would have less adverse effect upon the natural and recreational features of this river segment.

This crossing north of Moxie Stream between Moxie Gore and West Forks Plantation (the Preferred Alternative) is the least environmentally damaging practicable alternative and there is no reasonable alternative that would have less adverse impact on the natural and recreational features of the river segment when the Preferred Alternative is compared with the three potential alternatives: a crossing on CMP land about one mile downstream of Harris Dam (the CMP Land Alternative), a crossing near the Harris Station powerhouse (the Brookfield Alternative), and an underground alternative at the gorge crossing.

Portions of the CMP Land Alternative are bordered by conservation easements, portions would require new corridor, and that alternative would cross the upper gorge across the MPRP conserved lands. The Brookfield Alternative suffers similar issues, with the exception that the route would cross the river at Harris Dam. The CMP Land Alternative and the Brookfield Alternative would also result in greater environmental impacts due to increased transmission line length (the CMP Land and Brookfield Alternatives are 5.1 and 6.3 miles longer than the Preferred Alternative, respectively), and would result in a significant visual impact on

recreational users of the upper Kennebec Gorge and Indian Pond area. Accordingly, these alternatives would not have a less adverse effect on the natural and recreational features of the river segment than the Preferred Alternative. To the contrary, both alternatives present similar perceived visual concerns as the Preferred Alternative, and the Brookfield Alternative would be visible to all rafters and private boaters putting into the Kennebec River and most likely would be directly over the area where rafters are given instructions before launching. These alternatives therefore do not have less adverse effect on the natural and recreational features of the river segment, and are unreasonable as they would cost approximately \$30 million more than the Preferred Alternative.

The same is true of the underground alternative at the gorge crossing. The underground alternative would use horizontal directional drill (HDD) technology to cross beneath the Kennebec River Gorge, also costing approximately \$31 million more than standard overhead construction (see table below), and requiring additional facilities described in the applications (transition structures and a control building, as well as permanent roads on either side of the river, and the likely installation of a backup circuit in the event the primary circuit failed), rendering it more environmentally damaging than the Preferred Alternative.

The HDD would be approximately 2,900 feet in length and 360 feet in depth and would be utilized for the Kennebec River crossing to install a duct bank. The bore would pass beneath the river with approximately thirty feet (30') of clearance from the river bottom. The HVDC underground cable installation would require approximately fifteen hundred feet (1500') of open trenching to connect to the Cable Termination Stations on each side of the river. Upgrades on approximately fifteen miles of unimproved roads and associated bridges would be required to provide access to the Termination Stations in addition to the grading necessary for the stations and laydown area for drilling equipment. The two Termination Stations would be similar on both sides of the river, with an approximately 200 foot by 250 foot station footprint. CMP anticipates there would be significant natural resource impacts associated with these improvements.

Not only does the underground alternative therefore have an adverse effect on the natural features of the river segment and adjacent riparian areas, it also is exponentially more expensive than the Preferred Alternative and is therefore not a reasonable alternative. CMP estimated costs for the underground transmission line crossing and the overhead transmission line-three pole option. It should be noted that the overhead transmission line-three pole option is a design update to the five pole option originally submitted with the Project's applications on September 29, 2017. This redesign was completed to increase and maximize the forested buffer on both sides of the river bank and to remove three structures (3006-21, 3006-22 and 3006-23) from the line of sight of the users approaching the crossing point from upriver. The following table provides a cost estimate for both options and also provides the cost of each option as a percentage of the overall Project cost, for comparative purposes.

Alternatives	Cost (2021)	Cost as a percentage of overall Project cost
Underground Transmission Line	\$36,889,395	3.9%
Overhead Transmission Line (3 pole option)	\$6,076,287	0.6%

Not only is the Preferred Alternative the least expensive of the three alternatives, but it also has been designed to minimize impact to the P-RR subdistrict at the gorge by positioning transmission line structures outside of the P-RR subdistrict. Additionally, where terrain conditions permit, trees will be allowed to grow within the P-RR subdistrict adjacent to the gorge in areas where maximum tree heights are anticipated to remain below the conductor safety zone. Accordingly, the Preferred Alternative will have the least adverse effect on the natural and recreational features of the river segment when compared with the three potential alternatives.

- 3. At the site visit on November 13, 2017 the applicant appeared to be working on a redesign of the crossing which would reduce the number of structures near the Kennebec River, elevate the conductors farther above the river, increase the undisturbed buffer along the river. Please provide the new design as soon as possible and include photosimulations which show the view looking directly into the corridor from the river. Also, quantify the vegetation that will need to be cut in the “buffer” area of the Gorge, both during construction and maintenance activities. The Department will need to have an understanding of the height of the conductors and the wire safety zone as well as the height of the capable vegetation that currently exists. If vegetation will be removed in this area (through maintenance activities) we need to evaluate that.**

RESPONSE

In its NECEC Site Law application submitted on September 27, 2017, CMP proposed a five-structure configuration over the Kennebec River Gorge crossing. Based on the original cross section and photosimulation, three of the five structures would be within the line of sight of users on the river. A 150-foot wide forested buffer was proposed on the southeastern river bank and a 250-foot wide forested buffer was proposed on the northwestern river bank. The vertical distance from the lowest conductor to the river was 150 feet (+/-) at maximum sag based on this five-structure design.

CMP has since redesigned the Kennebec River Gorge crossing to increase and maximize the forested buffer on both sides of the river bank and to remove Structures 3006-21, 3006-22 and 3006-23 from the line of sight of users approaching the crossing point from upriver.

On the southeastern river bank approximately 300 feet of forested buffer will be maintained, with trees within this buffer at an average mature height of 75 feet. On the northwestern river bank approximately 550 feet of forested buffer will be maintained, with trees within this buffer also at an average mature height of 75 feet. At the centerline of the river, the conductor will be approximately 200 feet above the water level at maximum sag.

Individual trees within the two forested buffers that grow to heights which encroach into the conductor safety zone will be selectively cut and removed to maintain minimum required conductor clearance. Trees and vegetation which do not encroach into the conductor safety zone will not be cut. The conductor safety zone is depicted on the Kennebec River Gorge crossing cross-section and is approximately 30 feet below the lowest conductor at maximum sag.

Advantages of the proposed 3-Structure design compared to the 5-Structure design include: fewer structures; greater vertical clearance over water; greater vertical clearance over trees; retention of trees over a larger area of forested buffer; and screened views of the transmission line structures and the cleared corridor from the perspective of river users.

CMP provided revised photosimulations and cross sections depicting the 3-pole structure redesign in an email to MDEP on December 12, 2017. Upon further conversations with LUPC, CMP is providing (attached to this submittal) revised photosimulations, dated January 22, 2018, of the 3-pole structure redesign, at a “normal view,” removing the distortion and providing a more accurate depiction of the conductor sag over the river. Additionally, the mark-up of the panoramic photos includes overlaid scale references and additional detail of the low point of the conductor sag and the assumed average of the 75-foot existing tree height. See Attachment A: Kennebec River Gorge Photosimulations.

4. The crossing of the Kennebec River below Wyman Dam is over an Outstanding River Segment (38 M.R.S. § 480-P(8)). The applicant will need to demonstrate that no reasonable alternative exists that would have less adverse effect upon the natural and recreational features of the river segment.

RESPONSE

As discussed in detail in Chapter 2 of the NRPA Application, the Preferred Route for the HVDC line was considered against Alternative 1 (HQ Legacy) and Alternative 2 (Bigelow). Alternative 2 proposes the same route at this river crossing. Alternative 1 would avoid crossing the Kennebec River below Wyman Dam, however, when considering all other criteria, the Preferred Route causes the least environmental impacts. The crossing of the Kennebec River at this location is co-located within an existing, developed CMP transmission line corridor. The proposed crossing location and design minimizes required clearing width (75 feet) and will also minimize impacts to the long-leaved bluet natural plant community.

An alternative Kennebec River crossing location would entail establishing a new corridor and river crossing, would require additional land acquisition, and would cause additional resource impacts and approximately 150 feet of new clearing width to accommodate the new line. Accordingly, no reasonable alternative exists which would have less adverse effect upon the natural and recreational features of this river segment. The current proposed alignment within the existing CMP corridor, which minimizes clearing and natural resource impacts, is the option with the least adverse effect upon the natural and recreational features of this river segment.

- 5. The crossing of the Carrabasset River is an Outstanding River Segment. The applicant needs to demonstrate that no reasonable alternative exists that would have less adverse effect upon the natural and recreational features of the river segment. Also, please provide photosimulations for this crossing, including simulations looking directly into the corridor.**

RESPONSE

As discussed in detail in Chapter 2 of the NRPA Application, the Preferred Route for the HVDC line was considered against Alternative 1 (HQ Legacy) and Alternative 2 (Bigelow). Alternative 2 proposes the same route at this crossing. Alternative 1 would avoid crossing the Carrabasset River in this location, however, when considering all other criteria, the Preferred Route causes the least environmental impacts. The crossing of the Carrabasset River is co-located within an existing CMP corridor. The proposed crossing location and design minimize required clearing (75 feet).

An alternative Carrabasset River crossing location would entail establishing a new corridor and river crossing, would require additional land acquisition, and would cause additional resource impacts and approximately 150 feet of new clearing width to accommodate the new line. Accordingly, no reasonable alternative exists which would have less adverse effect upon the natural and recreational features of this river segment. The current proposed alignment within the existing CMP corridor minimizes clearing and natural resource impacts and is the option with the least adverse effect. The requested photosimulations will be provided in a subsequent submittal.

- 6. The Sandy River in the location of the proposed crossing is an Outstanding River Segment and the applicant will need to demonstrate that no reasonable alternative exists that would have less adverse effect upon the natural and recreational features in the river segment. Also, please provide photosimulations for this crossing including simulations that look directly into the corridor from the river.**

RESPONSE

As discussed in detail in Chapter 2 of the NRPA Application, the Preferred Route for the HVDC line was considered against Alternative 1 (HQ Legacy) and Alternative 2 (Bigelow). Alternative 2 proposes the same route at this river crossing. Alternative 1 would avoid crossing the Sandy River in this location, however, when considering all other criteria, the Preferred Route causes the least environmental impacts. The transmission line is co-located within an existing CMP corridor at this river crossing. The proposed crossing location and design minimize required clearing (75 feet).

An alternative Sandy River crossing location would entail establishing a new corridor and river crossing, would require additional land acquisition, and would cause additional natural resource impacts and approximately 150 feet of new clearing width to accommodate the new line. Accordingly, no reasonable alternative exists which would have less adverse effect upon the natural and recreational features of this river segment. The current proposed alignment within

the existing CMP corridor minimizes clearing and natural resource impacts and is the option with the least adverse effect. The requested photosimulations will be provided in a subsequent submittal.

- 7. The West Branch of the Sheepscot River is over an Outstanding River Segment in the location of the proposed crossing and the applicant will need to demonstrate that no reasonable alternative exists that would have less adverse effect upon the natural and recreational features in the river segment. Also, please provide photosimulations for this crossing including simulations that look directly into the corridor from the river.**

RESPONSE

The crossing of the West Branch of the Sheepscot River is co-located within an existing CMP corridor and requires no additional tree clearing. An alternative crossing location of the West Branch of the Sheepscot River would entail establishing a new corridor and river crossing, would require additional land acquisition, and would cause additional natural resource impacts and approximately 150 feet of new clearing width to accommodate the new line.

The West Branch of the Sheepscot River is rated as an "A" river and an Outstanding River Segment in the 1982 Maine Rivers Study for its anadromous fisheries resources. The Study determined that the scenic resources of the West Branch of the Sheepscot River were not unique or significant, i.e., they did not meet a minimum standard of significance. The proposed transmission line should have a relatively minor visual impact on the West Branch of the Sheepscot River at the crossing location, since there are already multiple transmission lines in the immediate vicinity of the river crossing and the width of the maintained transmission line corridor will not change. The current alignment in the existing CMP corridor minimizes clearing and natural resource impacts and is the option with the least adverse effect upon the natural and recreational features of this river segment. Accordingly, no reasonable alternative exists which would have less adverse effect upon the natural and recreational features of this river segment. The requested photosimulations will be provided in a subsequent submittal.

ENVIRONMENTAL INFORMATION REQUEST
General Questions
December 12, 2017

- 1. Please describe the non-specular conductors. Where are these to be located, along the entire length of the project or only in certain locations?**

RESPONSE

Non-specular conductor is aluminum conductor that has had its surface either mechanically or chemically treated to reduce its reflectivity. Non-specular conductor surface has a smooth matte gray finish which blends in with the environment. Non-specular finish is typically achieved by passing the conductor through a sandblast machine in which the conductor surface is blasted with a very fine mild abrasive grit to produce this matte finish. The reflectivity and color of the finished cable is specified by ANSI C7.69 Specifications. Non-specular conductor is proposed only at the Kennebec River Gorge crossing.

- 2. How durable is the coating and does weathering change its appearance?**

RESPONSE

As described above, the process does not entail applying a coating that would weather over time, revealing a conductor surface that is more reflective. The conductor is physically altered to produce a less reflective surface, and this finish will endure for the life of the conductor. Furthermore, standard conductor is initially reflective but over a period of 2-5 years it weathers and exhibits characteristics similar to non-specular conductor.

- 3. Despite what Section 7 of the Site Location application says at the top of page 44, there are numerous structures located within 25 feet of rivers, streams, or brooks identified on the Waterbody Crossing Table. The closest one is a structure located with one-foot of Chase Stream in Moscow. For those crossings where a structure is located within 25 feet of the river, stream, or brook please provide a site-specific erosion control plan for that crossing. Also, please provide additional information on why these structures cannot be located further from these resources.**

RESPONSE

As the transmission design progresses, structure locations will be modified to maintain a minimum 25-foot setback from waterbodies to the maximum extent practicable. CMP will prepare and submit a site-specific erosion and sedimentation control plan for all structures that cannot be sited greater than 25 feet from a waterbody. A revised waterbody table will be provided in a subsequent submittal.

- 4. There appears to be some discrepancies in the Waterbody Crossing Table, particularly around the streams in mile 73 on Segment 2. The table has a crossing listed of ISTR-73-04, but I could not locate that stream on the resource maps. There is a stream labeled PSTR-73-04. Please recheck the crossing table with the resource maps to make sure they are correct.**

RESPONSE

ISTR-73-04 was delineated as part of the NECEC resource data collection, however, upon final route selection, this resource was outside the project right-of-way. Waterbodies outside of the project corridor were inadvertently included on the Waterbody Crossing Table. The table will be revised to omit those resources that are outside of the NECEC project right-of-way/CMP's ownership, and this table will be provided in a subsequent submittal.

- 5. Between Maine Yankee and structure 3027-204 there are no proposed structures and the line appears to run on existing structures. Is this correct? Are you going to utilize the existing structures?**

RESPONSE

Yes, as shown on the typical cross sections included in Attachment 1 of the Site Law application, the Section 3027 transmission line will be installed on existing lattice tower structures in this portion of Segment 5.

- 6. The Compensatory Mitigation package only deals with impacts to freshwater wetlands, IWWHs and SVPs. There is no discussion about compensation for impacts to other resources, such as cold-water fisheries or impacts to existing recreational uses of the Outstanding River Segments. The project crosses 67 rivers, streams, or brooks which contain brook trout habitat and five Outstanding River Segments and according to the vegetation management plan all vegetation over ten feet tall will be removed. While the Department has not yet made a determination whether the impacts to these resources are unreasonable there will certainly be impacts to these resources. Please provide a mitigation package to compensate for these impacts. The Department envisions this mitigation package will be the responsibility of CMP to implement, not simply providing additional ILF monies.**

RESPONSE

As stated in Section 13.0 of the NRPA Application, CMP intends to offset unavoidable impacts to natural resources through a contribution to the In-Lieu Fee ("ILF") Compensation Program. CMP used the ILF Fact Sheet as the foundation to identify those resources which have prescribed "ILF resource compensation rates" and "resource multipliers." Those resources with associated compensation formulas were identified in the Summary of Resource Impacts (Table 13-1). CMP will continue to engage the MDEP and USACE to assess project impacts to functions and values of protected natural resource areas and methods to avoid, minimize or mitigate those impacts through design, location, construction practices, ILF contribution and/or

compensatory mitigation parcels. CMP will request an interagency meeting with the MDEP and the USACE in Spring 2018 and will come to a mutually acceptable agreement on the terms of compensation for project impacts.

7. The noise report for the Fickett Road Substation states, “Without the operation of the cooling fans, the STATCOM would be under 40 dBA at the north property line...” What would the sound levels be with the cooling fans included in the modeling? In addition, the report indicates that this portion of the project may generate tonal sounds and therefore be subject to a 5-dBA penalty meaning the sound levels would need to be less 40-dBA at the nearest protected location. The noise contour map shows the 40-dBA line crossing the property line to the north and impacting PL1 and PL2. Please describe what noise mitigation measures will be taken to bring the project into compliance with the noise standard.

RESPONSE

For the Fickett Road Substation, cooling fan sound is included in the modeling results and associated figures. The above-referenced statement was intended to explain that broadband cooling fan noise (not tonal) dominates sound levels at the property line on the north side of the substation (PL2). Therefore, a 5 dBA tonal penalty was not added at this location. Mitigation measures would not be needed at this location since overall levels are modeled and anticipated to be below 45 dBA, and no tonal penalty would be added to the measured levels. Sound levels at all receivers with the fans off are modeled and anticipated to be below 40 dBA.

Note: the footnotes on Table 5-14 in the application are incorrect. The table should look like the table shown below. PL2 is dominated by non-tonal cooling fan noise, and therefore was not assessed a 5 dBA penalty.

Table 5-14: Modeled Operational Sound Levels

Modeled Receptor	Modeled Sound Level ^a (dBA)	Sound Level Requirement (dBA)
PL1 – Property Line	40.7	45
PL2 – Property Line ^b	41.9	45
PL3 – Property Line	35.9	45
PL4 – Property Line	36.4	45
PL5 – Property Line	27.5	45
PL6 – Property Line	30.7	45

(a) Modeled sound level is the substation sound level with an expected 5-dBA tonal penalty added.

(b) No tonal penalty applied to this location. Sound is dominated by cooling modules which are not tonal.

8. The noise report for the Coopers Mills Road Substation states that it is unclear whether this portion of the project will produce tonal sound, but even without a 5 dBA penalty, the anticipated sound levels will exceed the noise standards. Please analyze the sound levels from the equipment to be installed to determine if it creates tonal sound. Please describe what additional noise mitigation measure you propose to bring the project into compliance with the noise standards.

RESPONSE

As a conservative approach, it is assumed the substation will emit tonal sounds at the property line. The substation equipment (i.e., transformers and reactors) generates tones, per the MDEP definition, that could be measured at the property line when background sounds are low. For compliance demonstration, a 5 dBA penalty would be added to overall measured sound levels if a tone were present at that location, and the sound level with the penalty applied must remain below 45 dBA. Therefore, mitigation has been designed and proposed to limit sound emitted by the substation below 45 dBA minus the 5 dBA penalty (i.e., 40 dBA) at all points along the property line.

Source sound levels for the existing transformers and STATCOM equipment have been updated in the model to reflect the recently provided, vendor-specific sound levels for similar STATCOM equipment currently being installed at Coopers Mills Substation. With the change, the model-predicted sound levels are slightly higher than the previous submission. The substation property lines have also been updated to include all properties owned by CMP near the Coopers Mills Substation.

In order to limit substation sound to below 40 dBA at all property lines, walls were modeled next to the main transformer and next to the new STATCOM cooling fans. The transformer sound wall was designed to be 20 feet tall by 105 linear feet, in an “L” shape on the north and east sides of the transformer. The wall next to the STATCOM cooling fans was designed to be 10 feet tall by 70 linear feet, located on the north side of the fans. The new substation layout with the sound wall locations is depicted in Figure B-1 of Attachment B. The sound contours for the new substation layout are included as Figure B-2 of Attachment B.

The updated maximum property line sound levels are provided below in Table 1. The table includes sound levels for the substation with and without the walls. Each sound level shown in the table has been increased by 5 dBA to reflect the potential tonal penalty that could be applied when compared with the limits.

Table 1: Modeled Operational Sound Levels with Tonal Penalty

Modeled Receptor	Modeled Sound Level without Sound Walls ^a (dBA)	Modeled Sound Level with Sound Walls ^a (dBA)	Sound Level Requirement (dBA)
PL1 – Property Line	39.9	40.1	45
PL2 – Property Line	46.2	44.3	45
PL3 – Property Line	46.1	43.4	45
PL4 – Property Line	47.6	44.3	45

(a) Modeled sound level is the substation sound level including the addition of an expected 5 dBA tonal penalty.

Modeling indicates that with the two sound walls installed, the Coopers Mills Substation with the new STATCOM would remain below the MDEP sound level limits at all points along all property lines.

If subsequent modeling (using vendor-provided sound data on STATCOM equipment to be installed as part of the NECEC project) predicts that applicable MDEP sound level limits will be exceeded at any property lines, CMP will update its proposal to include sound walls. These walls would be designed to be mostly absorptive sound panels with standard sound reduction properties. Specific wall properties and dimensions will be determined during detailed design of the project.

9. Table 5-18 indicates that the predicted sound level at PL2 is 45.5-dBA and at PL3 is 45.8-dBA, however the sound contour map (figure 5.5.5) indicates that the predicted sound levels at these two property lines is near 40-dBA. Please indicate which is correct.

RESPONSE

The Modeled Sound Level shown in the various tables included an additional 5 dBA for the tonal penalty, as opposed to lowering the statutory limit (i.e., each level has been increased by 5 dBA to account for the tonal penalty if one is expected to occur). In Table 5-18 specifically, PL2 was modeled to equal 40.5 dBA, the level shown in the contour, but a 5 dBA penalty was added to this. Therefore, the sound level compared to the sound level limit shown in the table is 45.5 dBA with the penalty included, for a modeled/anticipated 40.5 dBA impact. Similarly, PL3 was increased to account for tonal sound (as was PL1). The footnote on Table 5-18 was incorrect. The correct footnote is shown below.

Table 5-18: Modeled Operational Sound Levels

Modeled Receptor	Modeled Sound Level ^a (dBA)	Sound Level Limit (dBA)
PL1 – Property Line	36.2	45
PL2 – Property Line	45.5	45
PL3 – Property Line	45.8	45

(a) Modeled sound level is the substation sound level with an expected 5-dBA tonal penalty added

As discussed in the response to information request #9 above, modeling indicates that, if needed, the installation of two sound walls would allow the Coopers Mills Substation to remain below the MDEP sound level limits at all points along all property lines.

10. Exhibit 7-3 provides information concerning impacts to IWWHs including the amount of acreage to be cleared. Please provide the cumulative amount of total of area to be cleared in IWWH.

RESPONSE

The cumulative total acreage to be cleared within all IWWHs is 22.30 acres. Exhibit 7-3 will be revised to accurately reflect the cumulative total acreage to be cleared in all IWWHs. The revised exhibit will be provided in a subsequent submittal.

11. Unlike the exhibit for IWWH, Exhibit 7-5 does not provide the amount of area to be cleared in the vernal pool habitats. Please provide the cumulative amount of area to be cleared in vernal pool habitats broken down by whether the pools are significant, potentially significant, or amphibian breeding areas.

RESPONSE

CMP will provide a response to this request concurrent with its response to the December 20, 2017, Maine Department of Inland Fisheries and Wildlife vernal pool data request provided to CMP by the MDEP.

12. The majority of the poles for the DC portion of the line are single-pole, self-weathering, structures that are approximately 100 feet tall. Will these structures be placed on a foundation or will they be placed in a drilled hole similar to other utility line structures? If they are to be placed on a foundation, please provide typical dimensions. Also, please provide typical dewatering plans for foundation holes, and site-specific plans for those structures within 75 feet of a protected natural resource.

RESPONSE

Whenever soil and loading conditions allow, structures on the DC portion of the line will be direct embed structures installed by excavating native soil, inserting the pole(s), and backfilling with suitable fill material which may include native soil, sand, rock, clean stone, concrete, and/or flowable fill (also known as controlled low strength material; flowable fill is a concrete-like mix used as non-structural fill primarily as a replacement for compacted backfill). Concrete or flowable fill will remain at or slightly above grade and the surface around the direct embed structure will be restored with native material and will cover the backfill material. The fill area for direct embed structures is approximately 40 square feet.

A number of concrete caisson-type foundations are likely to be required for angle and dead-end structures. While it is possible that some dead-end and angle structures could be direct embed structures with guy wires, CMP took the most conservative approach when estimating impacts by assuming that all angle and dead-end structures would require concrete foundations. As the design progresses, a final accounting of structures requiring concrete foundations (based on

construction access, subsurface soil profiles, structural analysis, etc.) will be performed. The fill area for concrete foundations will typically occupy approximately 80 square feet per pole.

Dewatering will be performed in all excavations containing water prior to backfill or concrete pouring activities. It is important to note that site conditions across the project vary widely and not all excavations will contain water or require dewatering. Topography and soil characteristics, as well as seasonal and weather variations, are just a few variables that can affect the presence of water and the need for dewatering, thus making it impractical to develop site specific plans for dewatering prior to construction activities. In all cases when dewatering is necessary, it will be conducted in a manner that minimizes impacts to water resources to the fullest extent practicable and maintains compliance with permit conditions and water quality standards. Such dewatering details are outlined in the attached NECEC Project Construction Dewatering Plan (see Attachment C).

13. The VCP states that there will be no accumulation of slash within 250 feet of an IWWH and impacts to scrub-shrub vegetation in and within 250 of an IWWH will be minimized. Do you mean within 250 of the wetland that creates the IWWH or do you mean 250 back from the edge of the IWWH? An IWWH includes the wetland as well as a 250-foot area around the wetland.

RESPONSE

Exhibit 10-1: NECEC Construction Vegetation Clearing Plan (“VCP”), Section 6.0 defines the IWWH as the “inland wetland complex used by waterfowl and wading birds, plus a 250 foot nesting habitat area surrounding the wetland. The nesting habitat is considered to be part of the mapped IWWH.” This definition is consistent with MDEP Regulations Chapter 305 (Natural Resources Protection Act – Permit by Rule Standards) and Chapter 335 (Wetlands and Waterbodies Protection). This section also states, “No additional buffers are proposed for IWWHs beyond this mapped habitat, and as such the vegetation maintenance restrictions apply to the mapped habitat only.”

Section 6.1 includes additional vegetation clearing restrictions within the IWWH, which (based on the definition in Section 6.0) apply only within the mapped habitat. Section 6.1, subsections g. and h. refer to accumulation of slash and impacts to vegetation “within 250 feet of the edge of the IWWH,” and “in and within 250 of the IWWH,” respectively. These subsections are inaccurate.

Consistent with the IWWH definition in MDEP regulations and in VCP Section 6.0, subsections g. and h. will be revised as follows:

g. No accumulation of slash will be left within the IWWH.

h. Impacts to scrub-shrub and herbaceous vegetation within the IWWH will be minimized to the maximum extent practicable.

A revised VCP will be submitted to MDEP in a subsequent submittal.

14. The VMP states that all woody vegetation in the wire zone, whether capable or non-capable will be cut during routine maintenance. Much of the DC line will be hung from structures that are approximately 100 feet tall, with the conductors, at the structure location approximately 75 feet above the ground. This will result in the conductors being substantially higher than other transmission lines with 45-foot tall structures. Why do non-capable species that are over ten feet tall need to be removed within 25 feet of streams and brooks, especially in that portion of the project from Beattie Township to the Forks?

RESPONSE

The VMP states: "Follow-up maintenance activities during operation of the line require the removal of 'capable species', dead trees, and 'hazard trees.' Capable trees are those plant species and individual specimens that are capable of growing tall enough to violate the required clearance between the conductor and vegetation established by NERC. Due to the sag of the electric transmission lines between the poles, which varies with the distance between poles, tension on the wire, electrical load, air temperature and other variables, the required clearance is typically achieved by removing all capable species during each maintenance cycle." The HVDC transmission line spans are a much greater distance than typical existing transmission lines supported by 45-foot tall poles. As such, conductor sag and height between the two is not an equal comparison. Further, there are additional restrictions that apply to vegetation maintenance within stream buffers, specifically "within that portion of the 25-foot stream buffer that is within the wire zone (i.e., within 15 feet, horizontally, of any conductor, see Figure 1 located at the end of the VMP). In this case all woody vegetation over 10 feet in height, whether capable or non-capable, will be cut back to ground level and resulting slash will be managed in accordance with the Maine Slash Law." The reason for removal of non-capable species over 10 feet tall within 25 feet of streams and brooks within the wire zone is because they have the potential to grow into the conductor safety zone between periodic (every 4 years) maintenance cycles. Additionally, allowing the vegetation to grow taller and larger prior to its cutting or removal would entail a more intensive maintenance effort requiring heavy equipment operation, would cause increased ground disturbance, and would result in a higher risk of sedimentation as well as temporary (e.g., wetland and waterbody crossings) and secondary impacts during each maintenance cycle.

15. In the vegetation maintenance restrictions within stream buffers, the VMP states that these additional restrictions will allow for taller vegetation within the 25-foot buffer area to provide additional shading and reduce impacts. With the exception of cutting by hand, restrictions on herbicide use, and restrictions on refueling, what different practices does CMP utilize during maintenance that allows for taller vegetation to grow? The first bullet in that sections states that all woody vegetation, whether capable or non-capable will be cut.

RESPONSE

The first bullet cited in the above question (#15), further clarifies that within the **wire zone** (i.e., within 15 feet, horizontally, of any conductor) all woody vegetation over 10 feet in height, whether capable or non-capable, will be cut back to ground level. This Plan also allows for taller vegetation within the 25-foot stream buffer to remain if it is located outside of the “wire zone” (see Figure 1 located at the end of the VMP). The “wire zone” does not include the full width of the ROW.

16. In the Installation of Crossings section of the Environmental Guidelines for Construction and Maintenance Activities on Transmission Line and Substation Projects, section 4.2, Installation of Culverts states, “Compaction should be done in no less than 8-inch lifts.” Should this read, “Compaction should be done in no more than 8-inch lifts”?

RESPONSE

Yes, CMP will revise this document accordingly.

17. In the Groundwater section of the application there is a discussion about abandoning groundwater wells. Do you know of any wells that will need to be abandoned as part of this project?

RESPONSE

No, the project as currently designed does not require that any groundwater wells be abandoned. The discussion was included in the application in the event of a design change that necessitates well abandonment or if a well is discovered that requires abandonment to protect groundwater or address safety concerns.

18. You will need to provide estimated quantities of construction debris and final disposal location(s).

RESPONSE

As discussed in Section 18.0 of the Site Law Application, CMP anticipates that solid waste generated from construction and demolition activities associated with the NECEC Project will be limited to land clearing and construction debris. The following table provides estimated quantities of wastes anticipated to be generated during the construction of the NECEC.

MATERIAL	Estimated Disposal Quantity (cubic yards)*
Wood (timber, slash, stumps, etc.)	30,000
Treated wood (poles, cross arms)	600
Metals (Ferrous and Non-Ferrous)	25
Porcelain Insulators	10
Food waste, plastics, common trash	50
Wooden Cable Spools & Pallets	120
Wooden Insulator Crates	8
Concrete Debris	25
Spoils (Transmission Lines)	5,700
Spoils (Substations)	31,000
Total	67,538

Note*: Wood materials associated with clearing will be sold as marketable timber, chipped for biomass facilities, manufactured into erosion control mulch (i.e., stumps), and/or chipped and spread within the Project right-of-way. CMP does not anticipate these materials to be shipped to a landfill. Wastes that will be recycled include metals, porcelain insulators, wooden cable spools, concrete debris and some plastics. Excess spoils will either be re-used on site, spread and revegetated within the right-of-way, or disposed of at an approved location.

CMP's priority is to minimize solid waste generation by implementing and utilizing environmentally responsible construction management practices. Furthermore, in the contract process for the project's general contractors, CMP will require, and provide oversight during construction to ensure, that the contractor complies with all applicable laws including the Maine Solid Waste Management and Recycling Law (38 M.R.S. § 2101 et seq.); federal hazardous waste regulations (Title 40 Code of Federal Regulations [CFR] Parts 260-279 and Part 124); and PCB regulations (US EPA Toxic Substances Control Act (TSCA) – 40 CFR 761). Under CMP's typical contract structure, demolition debris becomes the property of the contractor, which is contractually obligated to dispose of materials at an appropriate CMP-approved, state-licensed disposal facility or scrap yard. In the contract documents, CMP provides a list of owner-

**New England Clean Energy Connect
Response to Information Requests
March 29, 2018**

approved recycling and disposal facilities for each anticipated waste stream (See Attachment D). CMP allows the contractor to propose alternate disposal facilities, however these facilities must be pre-approved by CMP and in compliance with all applicable laws.

ENVIRONMENTAL INFORMATION REQUEST
Natural Resource Map Questions

New England Clean Energy Connect - Natural Resource Map Data Requests			
Project Segment	Map Page	MDEP Request For Information	CMP Response
November 20, 2017 Data Request			
2	123	Map ONLY included with Data Request. This row added to the spreadsheet by the Applicant.	The arrow drawn on the map seems to request a shift in the access road to the south to avoid WET-55-01. We agree that the access road should be shifted to the south side of structure 3006-S-476 to avoid the resource. This change to the maps and impact calculations will be incorporated once 60% engineering design is complete. Development of the more detailed design may shift some structure locations and access roads project-wide. CMP will analyze all access road locations from an impact and constructability standpoint. The updated maps and impact calculations will be submitted to the agencies for review as an amendment to the application.
2	148	There is construction access that crosses wetland 66-05 which is not needed. Structure 3006-S-418 can be accessed from the west and 3006-S-417 can be accessed from the east	Agreed, this section of access road is not needed. This change to the maps and impact calculations will be incorporated in a subsequent submittal.
2	155-156	Structure 3006-S-399 could be accessed from the east, eliminating the road from 3006-S-400 and two wetland crossings	Agreed. This change to the maps and impact calculations will be incorporated in a subsequent submittal.
2	157	The construction road to 3006-S-396 could be extended to 3006-S-395 eliminating one wetland crossing	This change will not eliminate wetland impact; WET-71-100 spans the entire cleared corridor width so some wetland impact is unavoidable in this location.
2	160	The construction road to 3006-S-388 can be relocated to avoid a wetland crossing	This change will not eliminate wetland impact; WET-71-100 spans the entire cleared corridor width so some wetland impact is unavoidable in this location. This access road will be slightly shifted to the south to traverse a narrower section of the wetland. This map change and impact calculations will be incorporated in a subsequent submittal.
3	188	Impacts to wetland 85-01 could be minimized by utilizing an upland island	Agreed, impacts to WET-85-01 can be minimized by shifting the access road to the west of the HVDC line. The changes will be incorporated in a subsequent submittal.
3	190	Impacts to wetland 86-03 can be completely avoided if the access road goes around it.	Agreed, the access road will be shifted to avoid the resource in a subsequent submittal.
3	193	Impacts to wetland 87-08 could be minimized by realigning the road	Agreed, the access road will be shifted to minimize impacts in a subsequent submittal.
3	194	Impacts to wetland 88-04 could be minimized by realigning the road	This access road will be reevaluated to minimize wetland impact and reduce conflicts in traveling under the existing line. The changes will be incorporated in a subsequent submittal.
3	212	Impacts to wetlands 96-02 & 96-03 could be minimized by realigning the road	Agreed, this access road will be shifted south of the existing overhead line, to minimize impacts to both of these resources. The changes will be incorporated in a subsequent submittal.
3	202	Impacts to wetland 91-07 could be reduced by accessing structure 3006-S-287 from the opposite direction	WET-91-07 cannot be accessed from the opposite direction; the proposed access change would conflict with a railroad bed.
3	217	Impacts to wetlands 98-03, 98-04, & 98-05 could be minimized by realigning the road	Agreed, the changes will be incorporated in a subsequent submittal.
3	218	Impacts to wetland 98-06 could be minimized by realigning the road	Agreed, the changes will be incorporated in a subsequent submittal.

New England Clean Energy Connect - Natural Resource Map Data Requests			
Project Segment	Map Page	MDEP Request For Information	CMP Response
3	220	Crossing PSTR 99-05 is not in the crossing table	Confirmed, this is included in Exhibit 7-7 NECEC Waterbody Crossing Table. Due to the way the Feature ID was named and organized, it is impossible to sort the table by geographic location. The table, as presented in the application, is sorted by Segment only, however all resources are included.
3	221	Impacts to wetland 100-03 can be avoided by realigning the road	Agreed, the changes will be incorporated in a subsequent submittal.
3	223	Impacts to wetlands 101-01 & 101-02 can be avoided by realigning the road	Impacts to WET-101-01 could be avoided completely by access road realignment. Impact to WET-101-02 will remain the same because this resource extends across the entire corridor width. The map mark-up suggests that impacts to WET-101-02 can be partly avoided by hugging the treeline, however avoidance won't be possible since the access road must be located a safe distance away from the trees.
3	226	Impacts to wetland 102-04 and SVPs 102-02 & 102-03 could be minimized by realigning the road	Agreed, access in this location will be realigned to minimize impacts and avoid conflict with the existing overhead lines and structures. Changes to access and impact calculations will be incorporated in a subsequent submittal.
3	227	Impacts to wetland 103-07 could be avoided by using what appears to be an existing road that runs along the edge of the cleared ROW	Agreed, the access road will be shifted to the west side of the corridor, which will avoid WET-103-07. Changes to access and impact calculations will be incorporated in a subsequent submittal.
3	229	Structure 3009-S-221 could be accessed using an existing road in the already cleared ROW and eliminate the crossing of wetland 104-01	While it appears that the existing road could be utilized, it also appears that there is an existing snowmobile bridge over PSTR-103-02, which may not accommodate heavy equipment travel. The existing road runs parallel to ISTR-103-01 suggesting that additional stream impacts would be incurred from this change. Accessing structure 3006-S-220 as proposed in the application involves temporary fill in WET-104-01 and avoids the two stream crossings, ISTR-103-01 or PSTR-103-12, reducing impacts to the streams and risk of sedimentation.
3	237	Impacts to wetland 107-06 could be avoided by realigning the road	Agreed, the changes will be incorporated in a subsequent submittal.
3	261	Impacts to wetland 116-02 and PSVP 118-02 could be minimized by utilizing an existing road to access structure 3006-S-142 all the way through the habitats and then turning to the structure	Agreed, the changes will be incorporated in a subsequent submittal.
3	264	Impacts to PSVP 119-03 could be minimized by utilizing an existing road to access structure 3006-S-135	The current alignment has some impacts to upland portions of the 250-foot critical terrestrial habitat associated with PSVP-119-03. This access was chosen to minimize temporary fill in WET-119-03 and VP-119-04 (also located within the CTH). The access road also runs adjacent to the clearing limits, which will be impacted by clearing crews. For these reasons, CMP favors the current access layout.
3	268	Impacts to wetland 121-03 could be minimized by access structure 3006-S-126 from the opposite direction	The current access road was chosen to avoid crossing stream PSTR 121-04. For this reason CMP favors the current access road alignment.
3	269	Impacts to wetland 121-04 could be eliminated by access structure 3006-S-124 from Moose Hill Road and structure 3006-S-125 from the Turmel Road	Agreed, the changes will be incorporated in a subsequent submittal.
3	277	Impacts to wetland 125-06 could be avoided by realigning the road	Agreed, the changes will be incorporated in a subsequent submittal.
3	285	Impacts to wetland 129-02 could be avoided by realigning the road	Agreed, the changes will be incorporated in a subsequent submittal.
3	288	Impacts to wetland 130-S-01 and PSVP 130-08 could be minimized by realigning the road and utilizing an existing road along the edge of the ROW to access structure 3006-S-79	The current access road was chosen to minimize wetland impact to WET-130-01, while staying close to the clearing limits, which will be traversed by clearing equipment. CMP favors the current access road layout.
3	310	Impacts to wetland 140-06 could be avoided by realigning the road	Agreed, the changes will be incorporated in a subsequent submittal.

New England Clean Energy Connect - Natural Resource Map Data Requests			
Project Segment	Map Page	MDEP Request For Information	CMP Response
3	311	Impacts to PSVP-140-04 could be minimized by straightening the road and utilizing the existing disturbed area along the edge of the cleared ROW	Agreed, changes will be incorporated in a subsequent submittal.
3	316	Impacts to wetland 143-01 could be reduced by accessing structure 3006-S-12 from an extension of the access road to structure 3006-S-11	Agreed, changes will be incorporated in a subsequent submittal.
4	342	Impacts to wetlands 154-02 & 154-03 could be avoided by realigning the road.	Agreed, changes will be incorporated in a subsequent submittal.
4	354	Impacts to wetland 159-08 could be minimized by realigning the access to structure 62-97 to an area outside the wetland	Agreed, changes will be incorporated in a subsequent submittal.
4	356	Impacts to wetland 160-08 could be avoided by realigning the road	Agreed, changes will be incorporated in a subsequent submittal.
4	358	Impacts to wetland 161-16 could be minimized by relocating the road to structures 62-133, 64-258, 62-122, & 64-238 to and area outside the wetland	Agreed, changes will be incorporated in a subsequent submittal.
4	358	Impacts to wetland 161-16 could be minimized by relocating the road to structures 64-260, 64-240, 64-123, & 64-239 to and area outside the wetland	Agreed, changes will be incorporated in a subsequent submittal.
5	366	The center line of the project between structures 3027-207 and 3027-208 goes outside of the ROW owned by CMP	The corridor alignment in this location was misinterpreted during the preparation of project mapping resulting in the omission of an angle in the corridor. The corrected map will show that the project as designed remains within the ownership of CMP. Tree clearing will be required between structure 3027-208 and 3027-204. These items will be corrected as the project design progresses. Additional impacts resulting from this change and updated natural resource maps will be provided in a subsequent submittal.
5	370	Impacts to wetland 183-01 could be minimized by utilizing an existing road to access structures 3027-189 and 3027-190	The access road will be reevaluated to minimize impacts to WET-183-01.
5	381-382	There is a road between structures 3027-142 and 3027-141 that does not appear to have any way to access it. Also, the structure numbering in this section appears to be out of sequence	Access was not proposed through this wetland/stream complex (PSTR-178-01, PSTR-178-02 and WET-178-06) due to sedimentation risk and constructability of access. The access road to structure 3027-142 enters the ROW at Gardiner Road on Map 374. The access road to structure 3027-141 enters the ROW at Lothrop Road on Map 383. The structures are numbered sequentially from north to south (Coopers to Maine Yankee), but the map set is laid out from south to north, creating some confusion to the reviewer. The map set will be laid out from south to north consistent with the structure numbering to clear up such confusion.
5	405	The road to structures 3027-57 through 3027-51 is between Cooper Road and Gardiner Road and impacts to wetland 167-01 could be minimized by eliminating the access from Cooper Road	This access cannot be eliminated since it provides access to structures 3021-51 through 49. Access is not proposed between 3027-49 and 48 due to known swampy/boggy area between these two structures. Impacts are minimized in this area by avoiding access between structure 3027-49 and 48.
December 12, 2017 Data Request			
1	3	Structure within 21 feet of PSTR-00-10	As the transmission design progresses, structure locations will be modified to maintain a minimum of 25 feet from waterbodies to the greatest extent practicable. CMP will prepare and submit a site-specific erosion and sedimentation control plan for all structures that cannot be sited greater than 25 feet from a waterbody. A revised waterbody table will be provided in a subsequent submittal.
1	115	Structure within 3 feet of ISTR51-14	See discussion regarding 25-foot waterbody setback above
1	35	Structure within 12 feet of ISTR-15-05	See discussion regarding 25-foot waterbody setback above
1	26	Structure within 8 feet of ISTR-RR-11-04	See discussion regarding 25-foot waterbody setback above
1	63	Structure within 5 feet of ISTR-SRDI-28-03	See discussion regarding 25-foot waterbody setback above

New England Clean Energy Connect - Natural Resource Map Data Requests			
Project Segment	Map Page	MDEP Request For Information	CMP Response
1	13	Structure within 8 feet of PSTR-05-02	See discussion regarding 25-foot waterbody setback above
1	100	Structure within 7 feet of PSTR-45-03	See discussion regarding 25-foot waterbody setback above
1	86,87	Structure within 8 feet of PSTR-38-06	See discussion regarding 25-foot waterbody setback above
1	63	Structure within 6 feet of PSTR-SRD1-28-01	See discussion regarding 25-foot waterbody setback above
2	161, 162	Structure within 15 feet of ISTR-73-05	See discussion regarding 25-foot waterbody setback above
2	162	Structure within 20 feet of ISTR-73-06	See discussion regarding 25-foot waterbody setback above
2	159, 160	Structure within 1-foot of PSTR-72-103	See discussion regarding 25-foot waterbody setback above
2	162	Structure within 21 feet of ISTR-73-04 according to the crossing table, but I could only locate ISTR-73-06 which does have a structure near it	The waterbody crossing table included a typographic error. The correct name of the waterbody is PSTR-73-04. A revised waterbody table will be provided in a subsequent submittal.
2	148	Structure within 3 feet of ISTR-66-09	See discussion regarding 25-foot waterbody setback above
2	149	Structure within 5 feet of ISTR-66-10	See discussion regarding 25-foot waterbody setback above
2	131	Structure within 16 feet of ISTR-59-02	See discussion regarding 25-foot waterbody setback above
3	289	Structure within 15 feet of ISTR-131-01	See discussion regarding 25-foot waterbody setback above
3	307	Structure within 24 feet of ISTR-138-01	See discussion regarding 25-foot waterbody setback above
3	321, 322	Structure within 8 feet of pSTR-145-01	See discussion regarding 25-foot waterbody setback above
4	358	Structure within 15 feet of PSTR-161-01	See discussion regarding 25-foot waterbody setback above
5	366	Structure within 23 feet of ISTR-185-03	See discussion regarding 25-foot waterbody setback above
5	MULTIPLE	Many of the distances to the nearest structure on Segment 5 are thousands of feet away. Are these distances correct? There is one, the crossing of ISTR-188-01, that the closest structure is 15,388 feet away. How is this possible?	Waterbodies within the project area that are thousands of feet away from the nearest new structure on Segment 5 are located on maps 359 through 364. As shown on the typical cross sections included in Attachment 1 of the Site Law application, the Section 3027 transmission line will be installed on existing lattice tower structures in this portion of Segment 5.
March 19, 2018 Data Request			
1	11, 12	End construction road at Structure 3006-263 and access Structure from 3006-262 from opposite direction and eliminate impacts to Wetland LT-6 and PSVP LT-3.	An off ROW access road is incorrectly identified as entering the ROW near Wet-LT-12. We have eliminated this access road from consideration because it would require additional clearing and improvements in the LUPC P-RR subdistrict. Access road impacts between structure 3006-263 and 262 will be within an area impacted by clearing activities.
1	22	Move access road to avoid Wet 09-01.	We will make the suggested adjustment near WET-09-01.
1	30	Move access road to minimize impacts to Wet 0913-13 and 13-15.	We propose to eliminate the access road between 3006-218 and 3006-2017, avoiding impact to WET-13-13, WET-13-15, WET-13-16, WET-13-17, WET-13-09, ISTR-13-15 and ISTR 13-16. To access 3006-2017, the access road from 3006-16 would be extended which would impact WET-13-07 and ISTR-13-10, however this option would minimize the number of resources impacted and the overall impact (square feet) at this location.

New England Clean Energy Connect - Natural Resource Map Data Requests			
Project Segment	Map Page	MDEP Request For Information	CMP Response
1	37	Move access road to avoid Wet 16-14.	The suggested access road shift would result in additional tree clearing in an area outside the clearing limit. The existing access road depicted on Map 37 shows the use of an existing road turnout off of Spencer Road. Not using the existing turnout, which would include matting the wetland, might result in contractor personnel mistakenly utilizing the turnout regardless, with additional risk to WET-16-14.
1	39	End construction road at Structure 3006-198 and access Structure 3006-197 from opposite direction and eliminate impacts to Wetland 17-11.	The current access road layout extends the access between 3006-198 and 3006-197, proposing temporary fill of timber mats in WET-17-11. An access road between 3006-196 and 3006-197 was not considered, due to the potential impact to PSTR-17-07 and PSTR-17R-03, a braided perennial stream. There is higher risk of sedimentation to this coldwater fishery from equipment tracking or soil disturbance on either side of the crossing if travel were to be permitted. The access through WET-17-11 will be matted in an area that will have been already disturbed by clearing crews and will be allowed to revegetate during the following growing season.
1	67, 68	Eliminate the construction access road in Wet-SR-30-02 and access Structure 3006-127 from an existing logging road that crosses the ROW between Structures 3006-127 and 3006-126.	It appears that the access between 3006-127 and 3006-128 is not needed and we will make this change to the maps.
1	82	Move the construction access road to minimize impacts to Wet-36-07.	We will change the access road alignment to minimize impacts to WET-36-07.
1	115	Move the construction access road to minimize impacts to Wet-51-08.	We will change the access road alignment to minimize impacts to WET-51-08.
1	90	Move the construction access road to minimize impacts to Wet-40-18.	The suggested access road shift is outside of the clearing limit and would require additional tree removal and potential ground disturbance. To minimize impact to this resource, we propose to shift the access road to the north side of the proposed centerline but remain with the clearing limits.

Attachment A
Kennebec River Gorge Photosimulations

PHOTOSIMULATION 11: KENNEBEC GORGE Looking North, Moxie Gore, 3 Structure Option



Proposed Conditions: Panoramic view looking from north to east from near the picnic area on the Kennebec River, 1,400'+/- south of the proposed HVDC transmission line crossing. The top of one structure will be visible from this viewpoint at a distance of 1,530'. A forested buffer of approximately 550' will be maintained along the northwest shore between the shoreline and the closest structure. The conductors would be approximately 200' above the water level. Approximately eighteen marker balls will be placed on the shield wires. See Appendix B: Study Area Photographs for additional images.

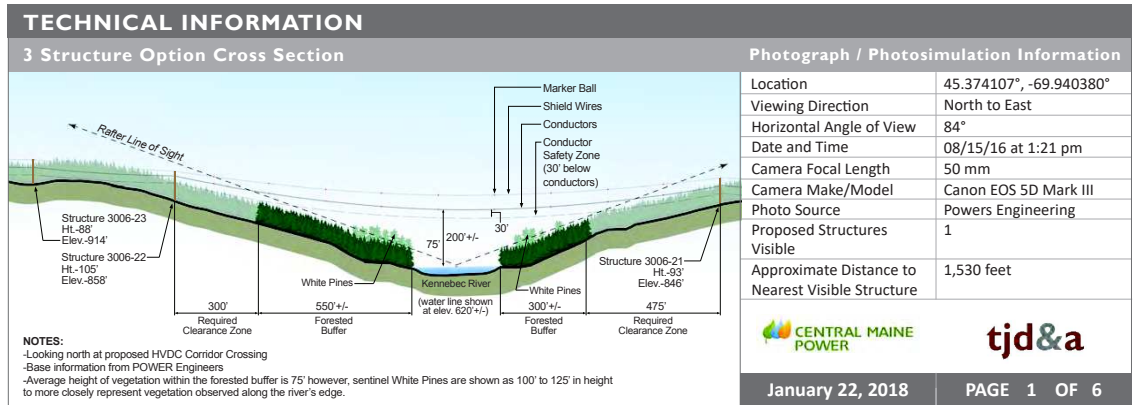
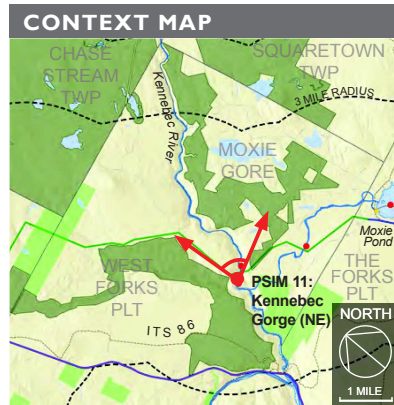
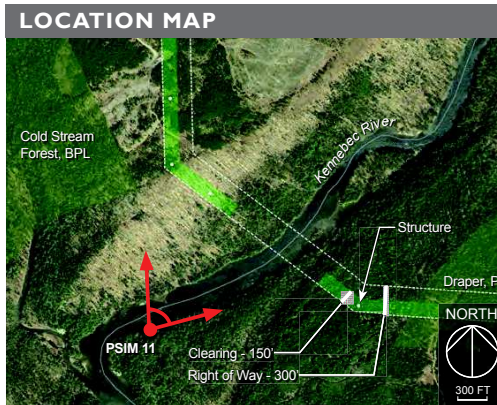

PHOTOSIMULATION 11: KENNEBEC GORGE Looking North, Moxie Gore, 3 Structure Option

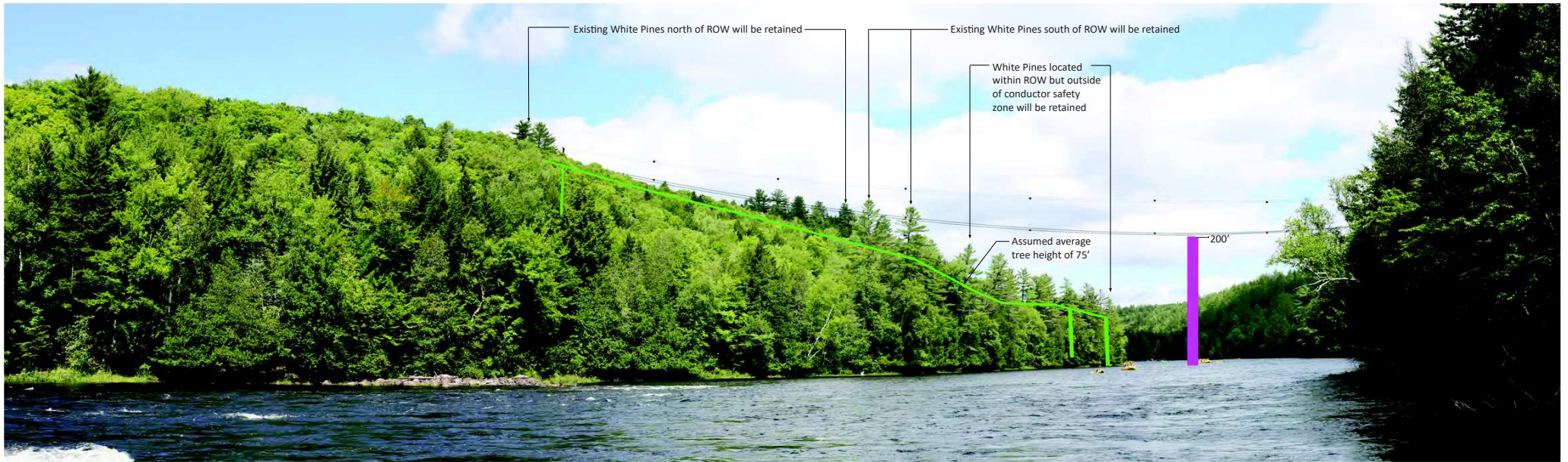

Proposed Conditions: Panoramic view looking from north to east from near the picnic area on the Kennebec River, 1,400'+/- south of the proposed HVDC transmission line crossing. The top of one structure will be visible from this viewpoint at a distance of 1,530'. A forested buffer of approximately 550' will be maintained along the northwest shore between the shoreline and the closest structure. The conductors would be approximately 200' above the water level. Approximately eighteen marker balls will be placed on the shield wires. See Appendix B: Study Area Photographs for additional images.

Scale Reference from 3D Model: The green lines represent an assumed average height of 75' for existing trees. Several white pines along the river's edge appear taller than 75' in height. The magenta line represents 200' from the water surface directly beneath the proposed conductors (lowest point in conductor sag).

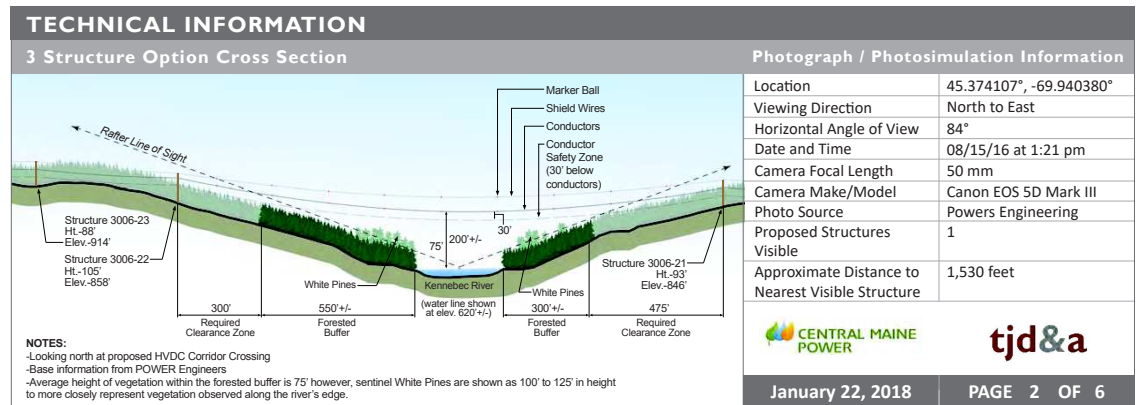
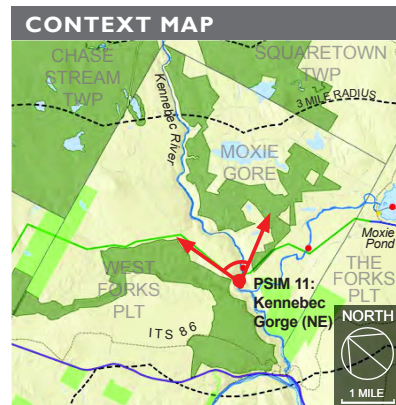
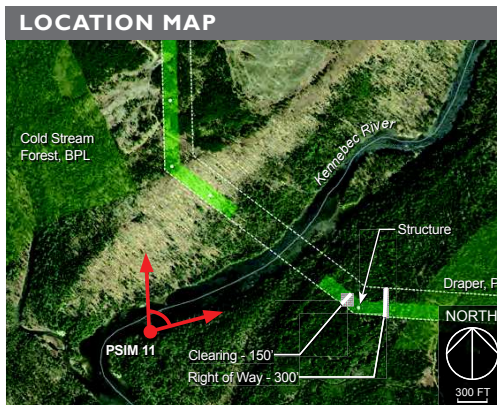



Existing Conditions: Normal view looking northeast from the Kennebec Gorge.

PHOTOSIMULATION IIA: KENNEBEC GORGE Looking Northeast, Moxie Gore, 3 Structure Option



Proposed Conditions: Normal view looking northeast from near the picnic area on the Kennebec River 1,400' +/- south of the proposed HVDC transmission line crossing. The top of one structure will be visible from this viewpoint at a distance of 1,530'. The lowest point of the conductors would be approximately 200' above the water level. Approximately eighteen marker balls will be placed on the shield wires and conductors above the Kennebec Gorge.



Existing Conditions: Normal view looking northeast from the Kennebec Gorge.

PHOTOSIMULATION IIB: KENNEBEC GORGE Looking Northeast, Moxie Gore, 3 Structure Option



Proposed Conditions: Normal view looking northeast from near the picnic area on the Kennebec River 1,400'+/- south of the proposed HVDC transmission line crossing. The lowest point of the conductors would be approximately 200' above the water level. Approximately eighteen marker balls will be placed on the shield wires and conductors above the Kennebec Gorge.

PHOTOSIMULATION 32: KENNEBEC GORGE PICNIC AREA Looking Southwest, 3 Structure Option
MODEL OVERLAY REFERENCE

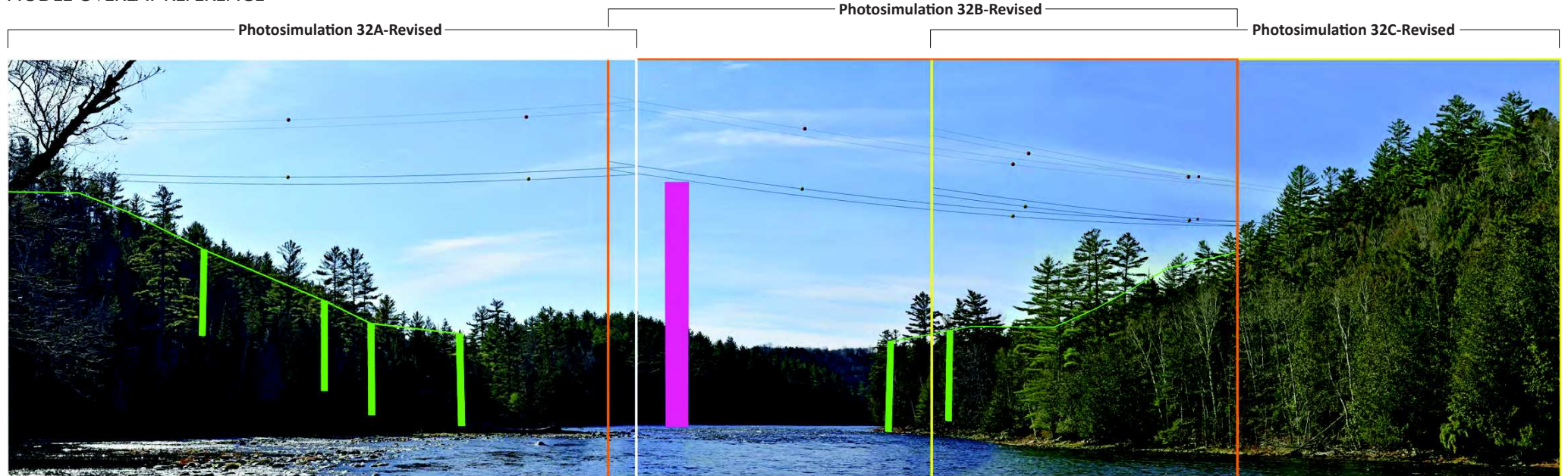

Proposed Conditions: Panoramic view looking from south to southwest from a point 750' +/- north of the proposed HVDC transmission line crossing of the Kennebec River near a rafting company picnic area. The closest structure, screened by vegetation in this view, is 850' +/- to the south. Conductors, approximately 200' above the river, will be visible to recreational boaters for approximately 1,600' approaching the crossing. Marker balls will be visible on the shield wires and conductors.

3D MODEL Scale Reference: This panoramic diagram shows the 'normal' view output from the modeling software over the merged panoramic image. Due to the relatively close (750') distance of the viewer to the proposed conductors, the lines appear similar to a "fish eye" lens (i.e. the conductors seem wider and higher over the middle of the river). In the photosimulation submitted on 12/12/17, the location of the conductors were adjusted to appear as continuous lines which resulted in the lines appearing to be approximately 25' lower than they would appear from this viewpoint. The proposed Project visibility is best assessed by reviewing the normal views because there is no distortion, see the updated images included on the following pages. Also included in the image above are scale references from the 3D Model; the magenta line represents 200' from the water surface directly beneath the proposed conductors (lowest point of conductor sag) and the green lines represent an assumed average height of 75' for existing trees within the Project corridor. Several white pines along the river's edge appear taller than 75' in height.

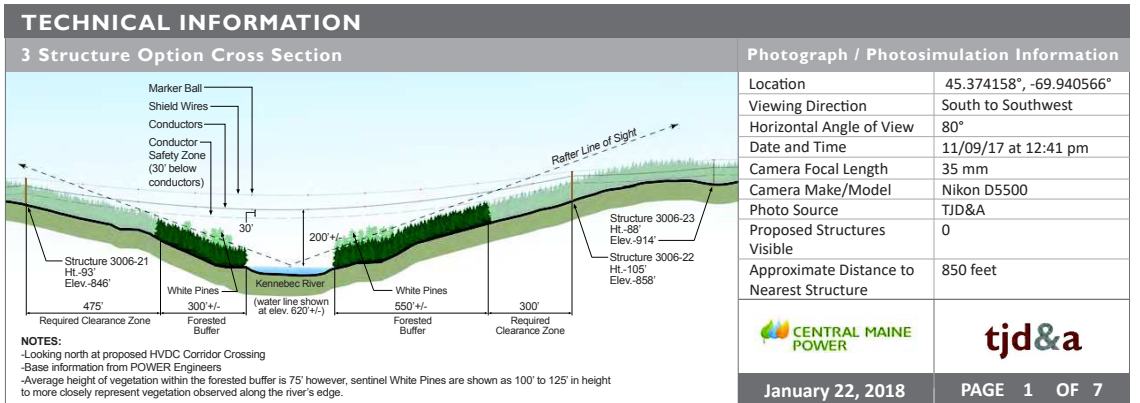
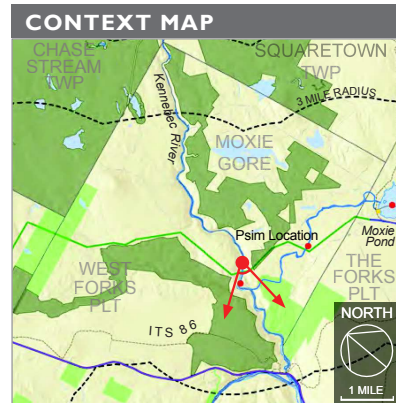
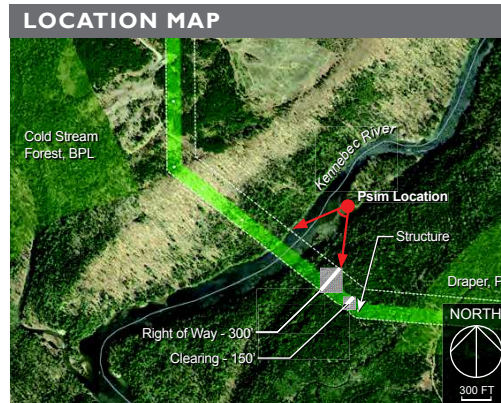



Existing Conditions: Normal view looking south from a picnic area on the Kennebec River.

PHOTOSIMULATION 32A Revised: KENNEBEC GORGE PICNIC AREA Looking Southwest, 3 Structure Option



Proposed Conditions: Normal view looking south from a point 750' +/- north of the proposed HVDC transmission line crossing of the Kennebec River near a picnic area. The closest structure, screened by vegetation in this view, is 850' +/- to the south. Conductors over the river will be visible to recreational boaters for approximately 1,600' approaching the crossing.



Existing Conditions: Normal view looking southwest from a picnic area on the Kennebec River.

PHOTOSIMULATION 32B Revised: KENNEBEC GORGE PICNIC AREA Looking Southwest, 3 Structure Option



Proposed Conditions: Normal view looking southwest from a point 750' +/- north of the proposed HVDC transmission line crossing of the Kennebec River near picnic area. The closest structure, screened by vegetation in this view, is 850' +/- to the south. Conductors over the river will be visible to recreational boaters for approximately 1,600' approaching the crossing.



Existing Conditions: Normal view looking southwest from a picnic area on the Kennebec River.





Proposed Conditions: Normal view looking southwest from a point 750' +/- north of the proposed HVDC transmission line crossing of the Kennebec River near picnic area. The closest structure, screened by vegetation in this view, is 850' +/- to the south. Conductors over the river will be visible to recreational boaters for approximately 1,600' approaching the crossing.

Attachment B
Coopers Mills Substation Noise Modeling Figures



<ul style="list-style-type: none">• Sound Sources— Sound Walls▭ Buildings	<p style="text-align: center;">NORTH</p> <p style="text-align: center;">200 100 0 200</p> <p style="text-align: center;">Scale in Feet</p>		<p style="text-align: center;">Figure B-1</p> <p style="text-align: center;">CMP NECEC Coopers Mills Road Substation Modeling Layout</p>
---	--	---	--

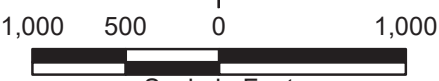

<ul style="list-style-type: none"> — 25 dBA — 30 dBA — 35 dBA — 40 dBA — 45 dBA — 50 dBA — 55 dBA — 60 dBA 	<ul style="list-style-type: none"> — Property Line ● Property Line Receivers 		 <p>Scale in Feet</p>		<p>Figure B-2</p> <p>CMP NECEC Coopers Mills Road Substation Sound Contours</p>
--	---	---	---	---	---

Attachment C
NECEC Project Construction Dewatering Plan

NECEC Project Construction Dewatering Plan

Construction dewatering may be necessary and may be the best option to manage stormwater or groundwater that enters a construction site on the project. Ground excavations that do not naturally drain to existing grade can trap rain and groundwater and this water must be removed from the site before certain operations can be performed safely. Stormwater and groundwater will be managed by the project with adequate treatment at discharge points to prevent sedimentation of downslope water resources.

Dewatering activities will be conducted in a manner as to:

- Prevent discharge waters from eroding soils or directly entering adjacent water resources
- Remove sediment from the collected water
- Preserve downslope natural resources and adjacent property
- Be located at a site that best achieves the necessary objectives

Considerations

Dewatering locations will be chosen at sufficient distances away from downslope water resources and on a surface that can treat or absorb the discharged waters. A well-vegetated upland buffer with a level or gently sloping terrain will be preferred as these areas provide the best filtration and/or absorption.

All dewatering activities from construction sites will be done in a manner as to not mix with oil, grease or other petroleum-based products, or with other hazardous materials. Contaminated runoff will be contained, treated, discharged or removed in accordance with all local, state, and federal permit conditions and consistent with Maine Erosion and Sediment Control Best Management Practices (BMPs). Dewatering activities will be stopped if project requirements cannot be met, i.e., if the dewatering or discharge site shows signs of erosion or instability, or if turbid water is threatening to enter or is visibly entering adjacent water resources.

Maintenance

All dewatering sites or dewatering structures will be routinely inspected by the contractor and by CMP's environmental inspectors for deficiencies, signs of erosion, or indications that discharge flows may damage the buffer vegetation or degrade the underlying soil. During the dewatering activity, the contractor will be required to continuously monitor discharge water conditions and to ascertain if additional treatment is necessary to effectively remove silt and other pollutants and to prevent erosion or sedimentation of downslope receiving waters.

Specifications

Discharged waters that are visually clear of sediment and turbidity, and have not mixed with other contaminants, will be directly discharged across a generally level, well-vegetated upland buffer, in a manner that promotes sheet flow with low energy. The Project will not discharge waters directly over bare or newly

vegetated soils, and the dewatering process will be stopped if the receiving area shows signs of instability or erosion, or if downslope waters shows signs of sedimentation or turbidity.

The following techniques will be considered based on the site conditions and to best facilitate the water removal process:

- Installation of diversion ditches or berms to minimize or prevent offsite stormwater runoff from entering the excavated area.
- Excavations and disturbance areas will be limited to only what is necessary for the current task and the excavated material will be placed on the upslope side of the work site.
- The water removal process may include, but may not limited to, drainage through stabilized channels, mechanical pumping, siphoning or use of a bucket from construction equipment.
- All channels, swales and ditches used for discharge will be adequately stabilized so that flow velocities do not cause erosion and instability. Stone lining or check dams are options for channel stabilization and energy dissipation.
- Dewatering activities will be avoided during forecasted heavy rain events to the extent practicable.

To best facilitate the sediment removal process, the following options may be used as standalone techniques or in combination, and will be considered and implemented as appropriate based on site-specific conditions:

- Use of a fabric bag (silt sack or dirt bag) to filter pumped water to be located within or near a vegetated upland buffer or natural depression, or within a temporary basin or sediment trap, generally constructed in the shape of a corral (either earth material, haybales, or erosion control mix berms) with silt fence and or geotextile fabric lining. See Figure 1.
- An excavated pit or settling pond for dewatering discharge may be dug where site conditions allow.
- Portable storage tanks may be brought onsite to store and treat larger volumes of water that require longer settling periods.
- If water quality/treatment objectives cannot be achieved with various dewatering methods, onsite discharge will not occur and off-site disposal via a pump truck may be necessary. Approval of the off-site disposal location will be required by CMP.

Figure 1. Typical Dewatering System

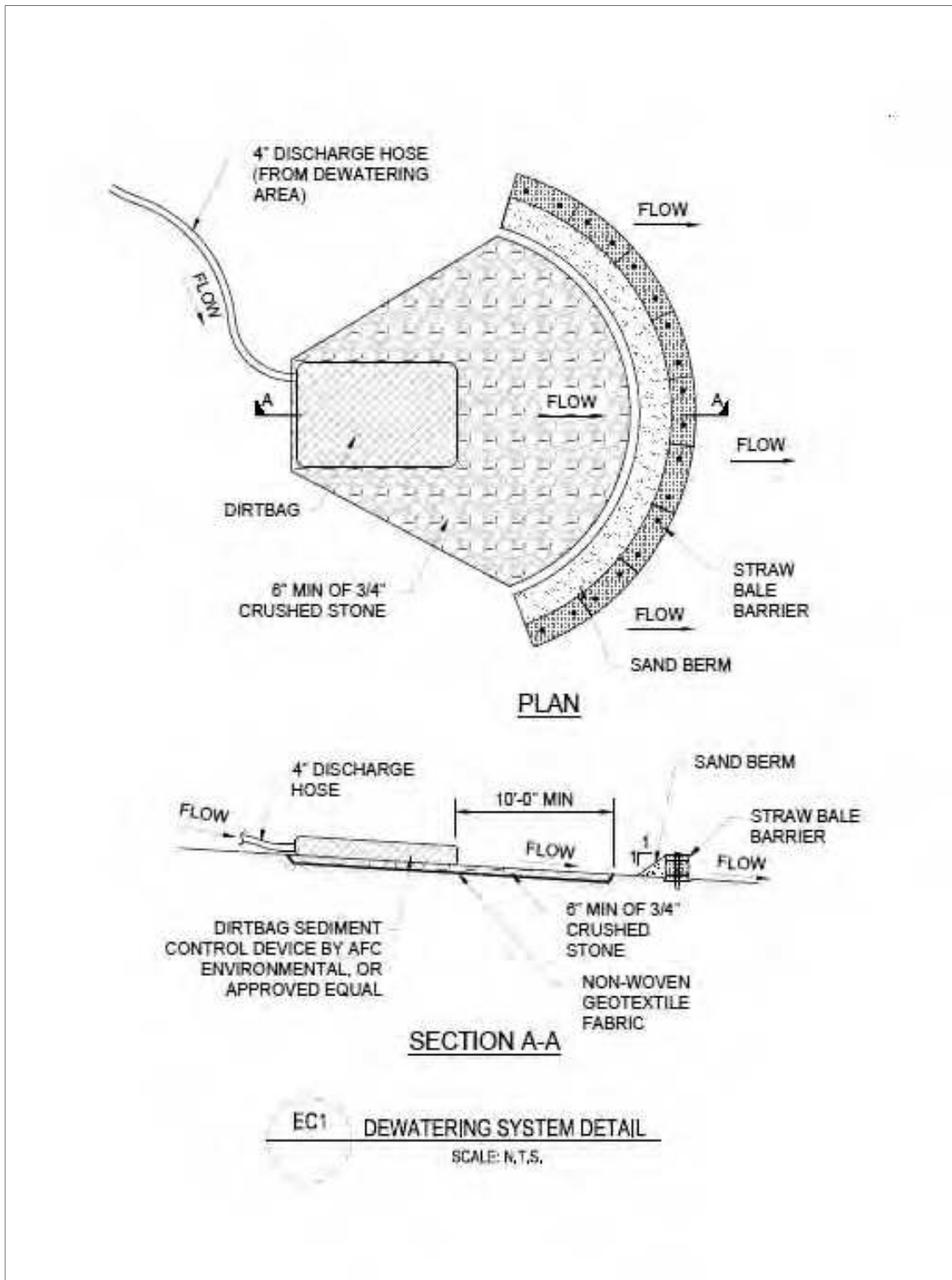

Note: Alternatives to the crushed stone underlayment include well vegetated surfaces and erosion control mulch. Straw bale barriers may be replaced by silt fence, erosion control mulch, or a combination thereof. Sand berms and geotextile fabric may be used as necessary to prevent turbid discharges to receiving waters.

Attachment D
CMP Waste Types and Approved Disposal Facilities

CMP Waste Types and Approved Disposal Facilities

Table 1: Types of Construction Wastes and Intended Disposal Methods

MATERIAL	DISPOSAL METHOD	CMP PROPOSED FACILITIES			
Excess Soil and Rock Material	Reuse on site for fill or construction needs or as off-site commercial fill or road base material, as practical	Waste Management Crossroads Landfill 357 Mercer Road Norridgewock, ME 04957 207-634-2714 207-562-7999	Juniper Ridge Landfill 2828 Bennoch Road Old Town, ME 04468 207-394-4372	Casella Waste Systems, Inc. Hampden landfill 358 Emerson Mill Road Hampden, ME 04444 207-862-4200	CPRC Recycling a.k.a. Commercial Paving 2 Gibson Road Scarborough, Maine 04074 207-883-3325
Untreated Wood (poles, timber, slash, stumps, etc.)	Remove for sale, recycling, on-site chipping and spreading, or off-site disposal	Contractor to propose			
Treated wood (poles, crossarms)	Transfer to Contractor or third parties or dispose of	Aggregate Recycling Corp. 434 Dow Highway (Rt. 236) Eliot, ME 03903 800-639-7303	Casella Waste Systems, Inc. Juniper Ridge Landfill 2828 Bennoch Road Old Town, ME 04468 207-394-4372	Waste Management Crossroads Landfill 357 Mercer Road Norridgewock, ME 04957 207-634-2714 207-562-7999	
Wooden Insulator Crates	Place in landfill as daily cover or waste	Casella Waste Systems, Inc. Juniper Ridge Landfill 2828 Bennoch Road Old Town, ME 04468 207-394-4372	Casella Waste Systems, Inc. Hampden landfill 358 Emerson Mill Road Hampden, ME 04444 207-862-4200	Contractor Alternate	
Wooden Cable Spools & Pallets	Reconditioned and/or reused	Stuart Irby Company 977 West River Rd. Waterville, ME 04901 207-872-7921	Contractor Alternate		

MATERIAL	DISPOSAL METHOD	CMP PROPOSED FACILITIES			
Scrap Cable Metals (Ferrous and Non-Ferrous) Aluminum	Recycled via third party or reused by CMP as the opportunity avails itself	E. Perry Iron & Metal 115 Lancaster Street Portland, ME 04101 207-775-3181	Maine Metals Recycling Co. 522 Washington Street Auburn, ME 04210 207-786-3531	Schnitzer Northeast-NEMR, LLC 25-39 Somerset St. Portland, ME 04101 207-772-8329	Contractor Alternate
Aerosol Cans	Recycled				
Paper	Recycled via third party or reused by CMP as the opportunity avails itself	FCR / Pine Tree Waste Owned by Casella Waste Systems, Inc. (various Maine locations) Local Contact Pine Tree Waste Services 87 Pleasant Hill Road Scarborough, ME, 04074 207-883-9777	Contractor Alternate		
Porcelain Insulators	Crushed and used as road sub-base material	CPRC Recycling a.k.a. Commercial Paving 2 Gibson Road Scarborough, Maine 04074 207-883-3325	Aggregate Recycling Corp. 434 Dow Highway (Rt. 236) Eliot, ME 03903 800-639-7303	Contractor Alternate	
Concrete Debris	Reuse as road sub-base or utilize/dispose of as inert fill				

MATERIAL	DISPOSAL METHOD	CMP PROPOSED FACILITIES			
Redeemable drink containers	Redeemed for recycling	Contractor to propose			
Paint Waste (Non-Hazardous)	Shipped to licensed MSW landfill, transfer station, or incinerator	Casella Waste Systems, Inc. Hampden landfill 358 Emerson Mill Road Hampden, ME 04444 207-862-4200	Contractor Alternate		
Food waste, plastics, common trash	Shipped to licensed MSW landfill, transfer station, or incinerator	Casella Waste Systems, Inc. Hampden landfill 358 Emerson Mill Road Hampden, ME 04444 207-862-4200	Contractor Alternate		
Housing Demolition Debris (asphalt roofing, painted wood and plywood, junk /abandoned cars, special or hazardous waste)	Waste will be managed on a case specific basis depending on the type of waste and the specific generation location	Veolia 218 Canton St Stoughton, MA 02072-2219 (781) 341-6080	Waste Management Crossroads Landfill Street Norridgewock, ME Zip 207-562-7999	Contractor Alternate	
PCBs	Any PCBs found on the site will be managed according to applicable Federal (TSCA) and State regulations	Contractor shall use one of the facilities in Table 2 that are approved by CMP			
Asbestos	Shipped to approved landfill	Contractor to propose			
Lead Paint chips or debris (not adhered to equipment)	Incinerated or otherwise managed as hazardous waste	Contractor shall use one of the facilities in Table 2 that are approved by CMP			
Mercury Containing Switches	Shipped to approved recycling facility	Contractor to propose			

Table 2: CMP-Approved Hazardous Waste Disposal Facilities

Company Name	Location	EPA ID #	CMP Material Disposed Of
Chemical Waste Management, Inc.	Model City, NY	NYD049836679	Oily Debris \geq 50 ppm PCB
Clean Harbors LLC	Ashtabula, OH	OHD986975399	PCB-Contaminated Electrical Equipment
Cyn Oil Corporation	Stoughton, MA	NHD981211832	Waste Mineral Oil <50 ppm PCB
Enpro Services of Maine	South Portland, ME	MED019051069	Gasoline Contaminated Debris
Enviro-Safe Corporation	Lowell, MA	CCC	Lead Acid Batteries and Spent Chemicals
General Chemical Corporation	Framingham, MA	MAD019371077	Lead Acid Batteries
Jones Environmental Services Northeast, Inc.	Lowell, MA	MAD047075734	Spent Chemicals
Pollution Control Industries	East Chicago, IN	IND000646943	Aerosol Cans, Gasoline Filters, Waste Paint, acetylene cylinders, petroleum distillates
Safety Kleen Systems - KY	Smithfield, KY	KYD053348108	Spent Chemicals, waste paint materials, aerosol cans, acetylene cylinders
Spring Grove Resource Recovery	Cincinnati, OH	OHD000816629	Electrical Equipment PCB Contaminated
Trans-Ind Inc.	Richmond, VA	VAD988224002	Electrical Equipment PCB Contaminated and non-PCB
Trans-Cycle Industries, Inc.	Pell City AL	ALD983167891	Electrical Equipment PCB Contaminated, Waste Mineral Oil \geq 50 ppm PCB, Mineral Oil \geq 500 ppm PCB, Oily Debris \geq 50 ppm PCB
Concorde Specialty Gases, Inc.	Eatontown, NJ	NA	Sulfur Hexafluoride (SF ₆) Gas

Attachment IV

March 23, 2018

Mr. Jay Clement
U.S. Army Corps of Engineers
Maine Project Office
442 Civic Center Drive, Suite 350
Augusta, Maine 04330

**RE: Responses to USACE February 23, 2018, Data Request
New England Clean Energy Connect Project
Application for Department of the Army Permit**

Dear Mr. Clement:

Central Maine Power Company (CMP) is pleased to provide responses to the United States Army Corps of Engineers (USACE) February 23, 2018, request for information associated with the Department of the Army Permit application submitted by CMP on September 29, 2017, for the New England Clean Energy Connect (NECEC) project.

The enclosed CD contains CMP's response and associated attachments along with the copy of the Presidential Permit Application you requested.

If you have any questions regarding these responses, please give me a call at (207) 626-9557 or email gerry.mirabile@cmpco.com.

Sincerely,



Gerry J. Mirabile
Manager – Environmental Projects
Environmental Permitting
AVANGRID Networks, Inc.

Enclosures

cc: James Beyer, MDEP; Samantha Horn, LUPC; Christopher Lawrence, USDOE; Melissa Pauley, USDOE; Bernardo Escudero, CMP; Mark Goodwin, Burns & McDonnell; Matt Manahan, Pierce Atwood; Jared des Rosiers, Pierce Atwood
File: New England Clean Energy Connect



NEW ENGLAND
CLEAN ENERGY
CONNECT

**Response to the
February 23, 2018
USACE Information Request**

New England Clean Energy Connect (NECEC)



**CENTRAL MAINE
POWER**

*Prepared for:
Department of the Army
New England District, Corps of Engineers
Application No. NAE-2017-01342*

March 23, 2018

ENVIRONMENTAL INFORMATION REQUEST FEBRUARY 23, 2018

Submission of the Application Form

RESPONSE

CMP provided a hard copy and digital version of the Corps application form (ENG FORM 4345, DEC 2014) along with the application materials on September 29, 2017. The December 2014 form was the most recent form available at the time of submission. CMP is providing an updated form, ENG FORM 4345, SEP 2017, as provided by the Corps with the February 23, 2018 data request. For your convenience, we have attached a copy of both the December 2014 and September 2017 forms in Attachment A of this response.

NRPA APPLICATION

- 1. Section 2.2, Purpose & Need. Please verify the project purpose has not changed in the view of the various state and utility decisions to date. Should Massachusetts ultimately decide not to select the NECEC project you will likely have to revisit this issue. CMP alleges that the project would move forward regardless, but such decision would not be supported by the project purpose which is currently MA-centric. Similarly, it would be unclear whether a capacity of 1200 MW was necessary or whether a smaller scale project could suffice. And presumably the air benefits that are sited (also MA-centric) may have to be re-addressed.**

RESPONSE

As of the date of this response, the Project's purpose has not changed. As you are aware, Massachusetts Department of Energy Resources (DOER) provided a public update to the Status of Section 83D Procurement on February 16, 2018 in light of the New Hampshire Site Evaluation Committee's (SEC) vote to deny Northern Pass Hydro (NPT) a Certificate of Site and Facility. As a result of the Certificate denial and the likely impact to NPT's schedule, the Electric Distribution Companies (EDCs) have entered into concurrent conditional contract negotiations with NECEC. If contract negotiations with NPT are not successful by March 27, 2018, the NECEC Project (Project) will move forward as the selected project in the Commonwealth's 83D clean energy Request for Proposal (RFP). Should NECEC not move forward under the current proposal, the Project's purpose will be updated and provided to the regulatory agencies.

The Status of Section 83D Procurement is available at <https://macleanenergy.com/2018/02/16/doer-update-on-section-83d-procurement-process/>.

- 2. Section 2.3.1, No Action Alternative. The discussion of the no action alternative needs to be clarified. The no action alternative presumably means a) the project is not built and the needs are not met; or b) some other project is built which addresses the needs. The reference to the economic benefits that CMP will lose through a no action alternative is immaterial and has no bearing in this discussion.**

RESPONSE

The no action alternative means maintaining the status quo (i.e., no project) in cases where a new project is proposed. 43 C.F.R. § 46.30. In this case, the no action alternative means no Project. It does not include the alternative of another project being built that addresses the need for the NECEC. And even if the Project does not move forward in the Commonwealth's RFP, the Project will still seek to fulfill the purpose and need of delivering renewable hydropower energy from Canada to New England, which has a continuing need for such power.

As explained in CMP's NRPA application, not constructing the Project is the no action alternative. Maintaining the status quo and not constructing the Project would not meet the Project's purpose of CMP delivering 1,200 MW of clean energy generation from Quebec to the New England Control Area at the lowest cost to ratepayers (see NRPA Application Section 2.3.1 No Action Alternative and Section 2.2 NECEC Purpose and Need). Nor would maintaining the status quo and not constructing the Project meet the need for the Project, as the no action alternative would not reduce greenhouse gas emissions, would not reduce the wholesale cost of electricity for the benefit of retail customers across the region, and would not enhance electric reliability.

There is no discussion in the Section 2.3.1 No Action Alternative narrative of any economic benefits that CMP would lose through a no action alternative. It merely states that the project purpose would not be met if the Project is not built. Nevertheless, should the Project not be built, the economic benefits to Maine (economic benefits during construction) and New England in general (reduced wholesale cost of electricity) would be lost. See Site Law Application Sections 1.4 and 1.6, referenced at NRPA Application Section 1.0.

- 3. Section 2.3.2, Alternatives. We suggest that the discussion of alternatives be reworded. Other alternatives may be more environmentally damaging but are they ‘impracticable’ as you note, probably not. I remind you of the Section 404(b)(1) Guidelines- an alternative is only impracticable if it is unavailable or incapable of being done after taking into consideration cost, existing technology, and logistics in light of overall project purposes. An alternative may also be dismissed if it is more environmentally damaging. If you dismiss an alternative as economically impracticable (too costly), you must put that into context with the overall cost of the project. For example, if burying the line in some segment will be multiple times more expensive than not burying it, how does the overall cost of the project change? The Corps encourages that all alternatives be analyzed and dismissed in accordance with the Section 404(b)(1) Guidelines. With a minimum of additional wording, the language in the guidelines could be added to make the analysis more fully compatible with the requirements of the Corps, the Maine DEP, and the federal resource agencies (US EPA, USFWS, and NMFS).**

RESPONSE

As stated in Section 2.3.2, the HVDC Alternative 1 and HVDC Alternative 2 are more environmentally damaging than the Preferred Route, and thus may be dismissed. See also Sections 2.3.2.2.2 and 2.3.2.3.2. As explained in the NRPA application, the Preferred Route is environmentally preferable because it is less environmentally damaging.

Cost was discussed in Section 2.3.2 only in reference to the cost and complexity of an underground Appalachian Trail corridor in HVDC Alternative 2. See Section 2.3.2.3.1 (Bigelow Corridor Description) (“The cost and complexity of an underground crossing, whether buried roadside in the Route 27 right of way or placed underneath the Appalachian Trail corridor via directional bore, would pose a financial barrier and an engineering challenge.”). As explained in CMP’s NRPA application, there is a probable need for HVDC Alternative 2 to cross the Appalachian Trail underground. CMP stated that underground transmission line construction costs can be approximately 4-10 times that of overhead construction, a cost that would not be borne in the Preferred Alternative, which would cross the Appalachian Trail in an existing corridor owned by CMP. See Section 2.3.2.3.1 (Bigelow Corridor Description).

With respect to the greenfield segment of the Project transmission line, CMP has now designed the transmission line in the north side of this 300 foot wide right of way to the same level (30%) as the south side design. CMP and its consultants are now evaluating and comparing the engineering and environmental aspects and impacts of the northern versus southern alternatives, and will make a decision regarding which orientation to advance to detailed design based on this evaluation. CMP will provide the results of this evaluation, consistent with the Section 404(b)(1) Guidelines, to the Corps in the near future.

4. Section 2.3.2.2.1. Why didn't the PUC approve the 1980 project? Please clarify.

RESPONSE

CMP acquired title, right, or interest on a significant portion of a transmission corridor in connection with a long-term power purchase agreement (PPA) proposed in Maine Public Utilities Commission (MPUC) Case No. 88-111. In that case, CMP petitioned for approval of a significant PPA with Hydro-Quebec (HQ) and proposed an interconnection between HQ and CMP that consisted of HVDC and AC lines and associated facilities. The MPUC, in a 2-1 decision (Gordon dissenting), determined that the economic benefits to CMP and its customers from the PPA were not materially better than other alternatives and therefore denied the petition. Because the PUC rejected the proposed PPA, it did not engage in more than a general inquiry with respect to the physical line itself.

5. Section 2.3.3, Merrill Road Converter Station. The narrative boils the discussion down to the preferred alternative and then alternative #1 but then speaks to alternative #2; a typo perhaps? And the narrative indicates that alternative #2 (#1?) is not practicable but it is, you allege that it's dismissed because it is just more environmentally damaging, correct?

RESPONSE

The narrative does include a typo when referencing "Alternative Parcel 2." The discussion eliminates the "CMP parcel" and "Alternative Parcel 2" as not being large enough to accommodate the substation site. A third alternative, "Alternative Parcel 3," was ruled out due to the presence of poorly drained and wetland soils. The discussion further identifies two properties as being the most suitable: 1) the "Preferred Parcel" and 2) "Alternative Parcel 1." Later in the discussion, the reference to "Alternative Parcel 2" is indeed a typo and should reference "Alternative Parcel 1."

The narrative contends that the "Alternative Parcel 1" is not practicable, however, in light of other factors it could be considered practicable, but it is not preferred due to greater environmental impacts associated with the additional transmission line length of 0.5 miles required for use of that site. Based on the discussion presented in Section 2.3.3, the "Preferred Parcel" is the least environmentally damaging practicable alternative and, therefore, preferred by the Project.

6. Section 2.4.1.1, Beattie Pond. CMP reportedly attempted to negotiate an alternative alignment south of the pond but could not come to mutually acceptable terms with the landowner. Was a reasonable good faith effort made relative to the value of the gross cost of the project and anticipated revenue?

RESPONSE

CMP did make a good faith effort to negotiate an alternative alignment south of the Beattie Pond P-RR subdistrict through Merrill Strip Township and offered the property owner three to four times the market value of the land. Avoiding the P-RR zone around Beattie Pond, located partially in Beattie Township (T2 R8 WBKP) and partially in Lowelltown Township (T1 R8 WBKP), would require the transmission line corridor to be located in Merrill Strip Township (T2 R7 WBKP) which is owned by Bayroot LLC. Bayroot LLC is managed by Wagner Forest Management (WFM).

CMP, through Dirigo Partners Ltd., its acquisition agent, approached WFM in the summer of 2014 with a proposal for an initial alignment for a transmission line corridor across Merrill Strip extending from the Quebec border to Skinner Township (T1 R7 WBKP). The proposed corridor had a length of about 3.4 miles and an area of about 82 acres. CMP offered \$2,000 per acre for the corridor, which was believed to be three to four times the market value of the land. WFM countered with a price of nearly \$46,000 per acre with limitations regarding future electric utility use of the corridor. This alignment had a segment that was close to the 2700 foot elevation and was several miles south of the current proposed border crossing point.

To avoid the higher elevation land and to have a border crossing point located in an area more acceptable to Hydro Quebec, Dirigo secured rights across land of E.J. Carrier in Beattie Township and then re-approached WFM with a revised alignment that was approximately 1 mile long with an area of about 40 acres. Dirigo had several discussions with WFM and offered additional modifications to the alignment to create more distance between the proposed corridor and a recreational lease located in Merrill Strip. However, WFM increased its price to about \$75,000 per acre for the corridor, again with limitations on the use of the corridor. WFM's price per acre for the 40 acres is equivalent to \$3 million, which is about 97% more per acre than CMP's above fair market value offer.

Finally, CMP senior management had several meetings with WFM with no better results. Dirigo then modified CMP's option agreements in both Skinner Township (Plum Creek Maine Timberlands) and Beattie Township (E.J. Carrier) to avoid Merrill Strip Township, and began negotiations with the Passamaquoddy Tribe for a crossing of the southwest corner of Lowelltown Township.

The CMP offer of \$2,000 per acre was a good faith offer and commensurate with the corridor purchase price of other new corridor on this Project when adjusted for corridor use and access. A higher price could have been justified if Bayroot was also willing to convey access rights and not place limitations on future utility use of the corridor but this adjusted price would still be only about 10% of Bayroot's counteroffer.

During the course of negotiations with WFM, CMP learned that WFM had entered into an option to lease with the Northern Pass Transmission Project for a transmission line corridor across land owned by Bayroot LLC in northern New Hampshire. CMP does not know if the agreement between WFM and Northern Pass affected the position (i.e., the high asking price and restrictions) of WFM in these negotiations. For these reasons, CMP determined that the land held by WFM was not available as an alternative.

7. Section 2.4.1.2, Kennebec River Gorge. Please confirm that the updated crossing designs and photo sims transmitted in your December 12, 2017 email are the most current (in view of our interagency site visit and any subsequent coordination you've had with DEP and LUPC staff). Is there any updated discussion of the directional drill alternative at this location we should be aware of?

RESPONSE

Upon further conversations with LUPC, CMP is providing revised photosimulations, dated January 22, 2018, which is an update to the December 12, 2017 photosimulations. The updated photosimulations are of the 3-pole structure redesign, at a "normal view," removing the distortion and providing a more accurate depiction of the conductor sag over the river. Additionally, the mark-up of the panoramic

photos includes overlaid scale references and additional detail of the low point of the conductor sag and the assumed average of the 75-foot existing tree height. See Attachment B: Kennebec River Gorge Photosimulations. At this time, there is no updated discussion of the directional drill alternative at the Kennebec River Gorge.

8. Section 2.4.1.2.1, Overhead Transmission Alternatives (for river crossing). A table comparing the environmental and other factors for the three options would be helpful here.

RESPONSE

To supplement the information provided in Section 2.4.1.2.1, CMP is providing the table below comparing the three transmission overhead alternatives for the Kennebec River crossing as depicted in Figure 2-6. CMP conducted the desktop analysis of the Preferred Alternative, Brookfield Alternative and CMP Land Alternative using publicly available Geographic Information System (GIS) data. The table presents several comparison criteria, consistent with Section 2.3.2.1. The findings in the table confirm the findings in the narrative, Section 2.4.1.2.1, and its support of the Preferred Route with respect to impacts to water resources (streams, wetlands and aquifers) and wildlife resources (IWWH). In addition, the application concludes that “both alternatives would present similar perceived visual concerns as the Preferred Alternative and would cost approximately \$30 million more than the Preferred Alternative”. The alternatives have therefore been dismissed due to the increased number of jurisdictional resources and greater environmental impacts associated with the additional transmission line length.

Kennebec River Crossing Overhead Alternative Comparison

Point of Comparison	Unit	Preferred Route	CMP Land Alternative	Brookfield Alternative
Conserved lands	no./acres	0 / 0	1 / 4.3	2 / 7.1
Undeveloped ROW	miles	8.3	6.7	6.6
Clearing	acres	151	147.3	157.9
Parcel count total	no.	1	24	25
Stream crossings	no.	3	13	13
Transmission line length	miles	8.2	13.3	14.5
NWI mapped wetlands	no./acres	6 / 6.8	38 / 17.4	38 / 14.0
Deer wintering areas (DWA)	no./acres	0 / 0	0 / 0	0 / 0
Inland waterfowl and wading bird habitat (IWWH)	no./acres	0 / 0	2 / 6.8	2 / 6.8
Public water supplies within 500 feet	no.	0	0	0
Significant sand and gravel aquifers	no.	0	1	1

9. Section 2.4.1.2.2, Directional Drill Alternative. Please put the noted additional cost of this alternative into perspective with the overall cost of the project.

RESPONSE

CMP conducted a study evaluating a ± 320 kV HVDC underground transmission line and termination stations at the Kennebec River crossing. The Horizontal Directional Drill (HDD) would be approximately 2,900 feet in length and 360 feet in depth and would be utilized for the Kennebec River crossing to install a duct bank. The bore would pass beneath the river with approximately thirty feet (30') of clearance from the river bottom. The HVDC underground cable installation would require approximately fifteen hundred feet (1500') of open trenching to connect to the Cable Termination Stations on each side of the river. Upgrades on approximately fifteen miles of unimproved roads and associated bridges would be required to provide access to the Termination Stations in addition to the grading necessary for the stations and laydown area for drilling equipment. The two termination stations would be similar on both sides of the river, with an approximate 200 foot by 250 foot station footprint. CMP anticipates there will be significant natural resource impacts associated with these improvements.

CMP's study included cost estimates for each alternative: the underground transmission line crossing and the overhead transmission line-three pole option. It should be noted that the overhead transmission line-three pole option is a design update to the five pole option originally submitted with the Project's applications on September 29, 2017. This redesign was completed to increase and maximize the forested buffer on both sides of the river bank and to remove three structures (3006-21, 3006-22 and 3006-23) from the line of the sight of the users approaching the crossing point from upriver. As noted in response to question 7, an updated photosimulation of the three-pole overhead option is attached to this submittal, Attachment B.

The table below provides a cost of both options and also provides the cost of each option as a percentage of the overall Project cost, for comparative purposes.

Alternatives	Cost (2021)	Cost as a percentage of overall Project cost
Underground Transmission Line	\$36,889,395	3.9%
Overhead Transmission Line (3 pole option)	\$6,076,287	0.6%

10. Section 12.1.2.2, Table 12-1. This table shows 4.49 acres of permanent wetland impact for substation development. Please verify that the remaining 0.21 acres of the referenced total project impact encompasses the entire project, Quebec- Southern Maine.

RESPONSE

We have reviewed the results of our GIS data query and have confirmed that the above referenced permanent wetland impact calculations encompass the entire Project. The 0.21 acres of permanent wetland impact are associated with permanent fill from 204 transmission poles. The Project has minimized permanent impact to wetlands by maximizing the average span for the HVDC line (~1,000 feet) and, to the extent practicable, siting structures sited outside of natural resource areas.

11. Section 13, Mitigation.

Please verify that Table 13-1 is reflective of the Corps current mitigation guidance (2016). Refer to our web site at:

https://www.nae.usace.army.mil/portals/74/docs/regulatory/Mitigation/2016_New_England_Compensatory_Mitigation_Guidance.pdf

- a. The table does not appear to address temporary conversion of wetlands, if any.
- b. How long will the temporary fills remain in place? Any temporary fills that remain in place longer than our prescribed time limits in the mitigation guidance may have required compensation.
- c. Please verify that the calculations for direct and indirect vernal pool impacts meet current state and federal guidance. For example, indirect impacts (clearing) that result in >25% loss of forested cover within 750' of the pool (250' for the DEP) may require compensation for an assumed full loss of pool productivity. Similarly, fills within 100' of the pool or within the pool itself may require compensation.
- d. I did not see the calculations in support of your suggested mitigation levels. Again, refer to our current mitigation guidance and capture all of the project's direct and indirect impacts to aquatic resources.
- e. Verify that for the 641 vernal pools identified along the existing alignment, that direct and indirect impacts don't rise to the level of requiring compensation.

RESPONSE

Section 13-1 of the NRPA application addresses compensatory mitigation requirements of both the MDEP and USACE, pursuant to NRPA 38 M.R.S. §480 (Z) and the 2016 USACE New England District Compensatory Mitigation Guidance ("USACE Guidance").

- a) The Project does not propose temporary conversion of wetlands. Forested wetlands within the clearing limits will be converted to early successional cover type wetlands, and maintained in such a state as part of CMP's permanently maintained transmission right-of-way.
- b) Section 13.2 of the NRPA Application states "All temporary impacts will be of short duration, i.e., less than 18 months, and typically much shorter than 18 months." CMP has been unable to identify prescribed time limits in the USACE Guidance and is awaiting further clarification from the USACE.
- c) CMP is in the process of developing this information and will provide a response to this request concurrent with its response to the December 20, 2017, Maine Department of Inland Fisheries and Wildlife vernal pool data request. The MDIFW data request was provided to CMP by the MDEP and forwarded to the USACE on February 13, 2018.
- d) CMP plans to meet with the ACOE and MDEP to determine mitigation ratios for the Project and to discuss mitigation that will be proposed to offset loss of functions and values to jurisdictional resources as a result of the Project. CMP will request an interagency meeting with the MDEP and the USACE in Spring 2018 and come to a mutually acceptable agreement on the terms of compensation for project impacts.
- e) See response to c (above).

SITE LAW APPLICATION

12. Section 1. Please verify that all of the descriptions and plans for other proposed upgrades to stations are up to date and they will not require new impacts to aquatic resources.

RESPONSE

As of the date of this response, the descriptions and plans provided in Section 1 of the Site Law Application have not changed and no additional impacts to aquatic resources are proposed. In the event the detailed design necessitates changes to the Project description or plans, they will be provided in a subsequent submittal.

13. Section 7.3.7.1, Canada lynx. Please summarize your latest coordination with USFWS.

RESPONSE

The Project has not had any post-filing coordination with USFWS regarding the Canada lynx. We are aware that the USFWS completed a scientific review of the Canada lynx and that the species may no longer warrant protection under the Endangered Species Act (USFWS News Release, 1/11/2018). We understand that the outcome of this analysis does not remove the species from Endangered Species Act protections, but the Agency may begin the process to delist the Canada lynx through the appropriate procedures. Despite the recent development, CMP plans to continue correspondence with wildlife biologists that specialize in Canada lynx and will provide its findings to the Army Corps.

14. Section 7.3.7.2, Bats. Please update the project's tree clearing limits (total for T-line and any substations). Section 7.4.4.2 notes a 1,809 acres of total conversion but elsewhere in the applications a figure of 124.14 acres is cited. Relative to the standard BMPs to minimize potential impacts to the species, can CMP restrict tree clearing to only the winter months (October 16 to April 19) and/or have no tree cutting between June 1-July 31 of any year?

RESPONSE

The total area of tree clearing for transmission lines and substations is approximately 1,809 acres as cited in Site Law Section 7.4.4.2. The total area of tree clearing in forested wetlands (permanent cover type conversion of forested wetlands) is 124.14 acres, as cited in NRPA Table 13-1: Summary of Resource Impacts.

As discussed in the Site Law application, the Project intends to meet the provisions described in the "Optional framework to Streamline Section 7 Consultation for the Northern Long-eared Bat." The Project will avoid prohibited incidental take outlined in the 4(d) Rule, by suspending tree clearing activities between June 1 through July 31 (maternity roost season) for any year during the NECEC's construction period to avoid disturbing known or unknown maternity roost trees. Additionally, CMP has confirmed with wildlife biologists that the Project is located greater than 0.25 miles from any known hibernaculum in the State, therefore clearing prohibitions outside of the maternity roost season would not apply.

In the July 19, 2017 Interagency Resource Consultation meeting between CMP, Burns & McDonnell, USACE, USFWS, MDIFW, and MNAP, Wende Mahaney (USFWS) stated that the agency recommends

winter clearing and that the action agency (USACE) will likely encourage the applicant to agree to no clearing between June 1 and July 31. As with all transmission line projects, CMP considers clearing during the winter months advantageous for numerous reasons including minimizing impacts to natural resources, and while a specific clearing schedule will not be determined until the project construction schedule is refined and a clearing contract is awarded, NECEC will strive to schedule clearing during the winter months.

15. Section 7.5.2.2, Salmon. There will apparently be no direct impacts to salmon streams but we need to quantify any indirect impact from clearing proximate to these resources.

RESPONSE

Approximately 40.3 acres of clearing will occur within 100 feet of salmon streams, all of which is in Segment 3 of the Project. Salmon streams were identified using NOAA's Atlantic Salmon Critical Habitat GIS data layer.

16. Exhibit 7-1, Agency Correspondence. The USFWS Official Species List notes the possible presence of small whorled pogonia. Guidance for field searches was provided by MNAP in June 2017, were plants or habitat found? Was this information coordinated with MNAP?

RESPONSE

CMP received the above referenced guidance from MNAP in June 2017 but did not conduct field surveys prior to the submission of the Project applications. CMP intends to perform a landscape analysis to identify areas for targeted field surveys for the small whorled pogonia, as well as other state listed rare plants and unusual natural communities, during the 2018 field season. CMP plans to perform the desktop review in April 2018, followed by field surveys during the summer of 2018. Both the desktop review and field survey effort will be coordinated closely with MNAP. The results will be provided to the agencies upon completion. Please see the preliminary schedule for rare plant studies and field work in Attachment C.

17. Section 9.1. The narrative indicates that surveys for state listed rare plants are not complete, what is the status of these investigations?

RESPONSE

Please refer to the response to question 16.

18. Section 10.1, Exhibit 10-1. Table 1 has a list of invasive species. This is far from a comprehensive list compared to those listed in our mitigation guidance. Please clarify.

RESPONSE

CMP will incorporate those species listed in *Appendix K: Invasive and Other Unacceptable Plant Species* within the *New England District Compensatory Mitigation Guidance*, dated 9-7-16 into its Exhibit 10-1: NECEC Plan for Protection of Sensitive Natural Resources During Initial Vegetation Clearing. CMP will develop an invasive species and vegetation monitoring plan based on the comprehensive species list provided by the Corps mitigation guidance. This plan will be submitted to the USACE and MDEP for review and approval prior to construction of the Project.

19. Section 19, Flooding. In the towns where the 30 structures and substations will be placed within or otherwise affect the 100 year flood plain you will be required to obtain a Flood Hazard Prevention Act permit. Any permit from the Corps will be so conditioned as a means of complying with Federal Executive Order 11988. You may wish to pursue these local permits now.

RESPONSE

During the municipal permitting phase of the Project, CMP will apply for and secure Flood Hazard Prevention Act permits in each affected municipality.

SITE LAW APPLICATION ATTACHMENT 1 Volume 1

20. Attachment 1, Plans. Please provide a master plan that shows the whole project route 1) on one sheet relative to the whole state; and b) in a more detailed view. This is for reference purposes in our future public notice.

RESPONSE

Attachment D contains a master sheet that shows the various Project segments in relation to the State of Maine. To provide a more detailed view, we have included area-specific depictions of the Project components on individual pages keyed to the master sheet.

21. Section maps. Please relabel the section maps with larger font so that they are more legible.

RESPONSE

The section maps, also known as natural resource maps, have been edited with larger font as requested. For reference, an example map page is provided in Attachment D. CMP intends to provide the entire updated map set and updated natural resource impact numbers when the engineered design is 70% complete.

22. Can the various sections be consolidated to a more limited number of 'typical' sheets for purposes of our future public notice? Can you also provide a generic web link that we can add to our public notice that would allow the public to view plans specific to their region or location of interest?

RESPONSE

As discussed with Jay Clement (USACE) on March 15, 2018, a subset of representative cross-sections, like those used in the public information meetings hosted by CMP, is included in Attachment D.

The application materials can be viewed at the MDEP's website:
<http://www.maine.gov/dep/land/projects/neccec/index.html>.

23. The Corps requires a more detailed set of plans for the border crossing. This is a requirement for our process, for our combined review with the Dept. of Energy (DOE), and for the review that must be conducted by the International Joint Commission.

RESPONSE

Please see the border crossing plan provided in Attachment D. CMP will update this plan with additional details if requested by the USACE or the DOE.

24. Please provide a 'typical' plan of a stream crossing using mats as well as a wetland crossing. If culverts or other measures will be used to insure wetland cross drainage or downstream flows, the section should show that.

RESPONSE

CMP will adopt the USACE New England District Construction Mat Best Management Practices (BMPs) and example typical figures included in Attachment E, and will require construction contractors to implement these BMPs. In addition, CMP will implement the BMPs for the use of construction mats included in Exhibit 10-1 and Exhibit 10-2 of the Site Law application. CMP is proposing to construct the Project with no in-stream construction activity. In the event atypical conditions necessitate the installation of a culvert, CMP will request a variance from the USACE and will not proceed without agency approval. The variance request will include a site-specific plan for the crossing that identifies the bank to bank width and other stream characteristics, photos of existing conditions at the crossing location, proposed culvert size, the anticipated duration that the culvert will be in place, and the restoration measures that will be implemented upon its removal.

25. Upon receipt of the additional information and application form the Corps will authorize a preliminary jurisdictional determination that will encompass the entire project. It will be necessary for CMP to sign this before we can issue a public notice.

RESPONSE

When available, please forward the applicable documents for CMP's signature.

26. In order to initiate Section 7 consultation with USFWS pursuant to the Endangered Species Act, the Corps will need to submit a biological assessment. The consultation process can be streamlined if you assist in the development of the BA. Please indicate your willingness to do so.

RESPONSE

CMP is willing to assist in the development of the BA. Please clarify CMP's and/or its consultants' role and expectation of draft deliverables as part of this process.

27. We are aware that the DEP has determined that a public hearing is a required element of their review. Since such a hearing may obviate the need to have a duplicative hearing by the Corps (and perhaps DOE), please update us on its proposed schedule. We would attend the hearing and if possible, reference it in our public notice.

RESPONSE

CMP and MDEP are currently discussing the scope of peer review on several components of the permit applications filed for the Project. In addition, CMP will be completing additional natural and cultural resource field surveys between April and September of 2018. It is currently anticipated that the hearing required by the MDEP will not be held until late summer or early fall of 2018 such that the results of the additional field survey and peer review work can be considered in that hearing. CMP will inform the USACE of the hearing date when it has been identified by the MDEP.

28. As you are aware, the Corps and DOE are coordinating our two permit processes in the interest of streamlining and avoiding duplication of effort. In addition to echoing the Corps request for plans for the border crossing, DOE has asked whether there have been any substantive changes to/refinement of the information previously provided to in their Presidential permit application. Please provide the Corps with a copy of their application and any updates.

RESPONSE

A copy of the Presidential permit application is being provided in CD format along with this response. There have been no updates to this application.

29. The DEP and by association, IF&W and MHPC have asked for additional information. Please copy the Corps on any response(s) to these requests. Of particular note, IF&W has asked for an updated vernal pool table. The Corps requests that all vernal pools be reflected on such a table, not just the 'significant' and 'natural' pools subject to state regulation. We're also interested in your response to DEP's technical questions on stormwater and erosion controls. And on November 28, 2017 MHPC requested additional survey information. That information must be provided in order for the Corps and DOE to continue consultation pursuant to Section 106 of the Historic Preservation Act.

RESPONSE

CMP will provide all data requests and responses to the Army Corps including, but not limited to the following agencies: DOE, MDEP, LUPC, MDIFW and MHPC.

30. We are aware that some of the other state data requests also require additional field work this season. It would be helpful to have a projected task list and timetable for anticipated field work and responses back to the interagency review team. Coupled with what we understand may be a late summer/early fall public hearing, it may make sense to delay issuance of our public notice and/or further processing. In the short term, it may also make sense to reconvene the interagency review team for a project update, particularly in light of the confusing (and apparently dynamic) MA and NH regulatory processes.

RESPONSE

CMP has prepared a preliminary schedule for tasks that require additional field work during the 2018 field season. CMP will execute the cultural resource surveys and rare plant surveys beginning in April 2018, as identified in Attachment C. These tasks will be advanced prior to a late summer/early fall hearing, and deliverables will be provided to the agencies as soon as they are available. CMP will update the Corps on anticipated deliverables availability dates as 2018 field work schedules are refined.

CMP plans to reconvene with the agencies for a Project update, and to continue compensatory mitigation discussions, in April of 2018.

Attachment A: USACE Application Forms

**U.S. ARMY CORPS OF ENGINEERS
APPLICATION FOR DEPARTMENT OF THE ARMY PERMIT**
33 CFR 325. The proponent agency is CECW-CO-R.

*Form Approved -
OMB No. 0710-0003
Expires: 30-SEPTEMBER-2015*

Public reporting for this collection of information is estimated to average 11 hours per response, including the time for reviewing instructions, searching existing data sources, gathering and maintaining the data needed, and completing and reviewing the collection of information. Send comments regarding this burden estimate or any other aspect of the collection of information, including suggestions for reducing this burden, to Department of Defense, Washington Headquarters, Executive Services and Communications Directorate, Information Management Division and to the Office of Management and Budget, Paperwork Reduction Project (0710-0003). Respondents should be aware that notwithstanding any other provision of law, no person shall be subject to any penalty for failing to comply with a collection of information if it does not display a currently valid OMB control number. Please DO NOT RETURN your form to either of those addresses. Completed applications must be submitted to the District Engineer having jurisdiction over the location of the proposed activity.

PRIVACY ACT STATEMENT

Authorities: Rivers and Harbors Act, Section 10, 33 USC 403; Clean Water Act, Section 404, 33 USC 1344; Marine Protection, Research, and Sanctuaries Act, Section 103, 33 USC 1413; Regulatory Programs of the Corps of Engineers; Final Rule 33 CFR 320-332. Principal Purpose: Information provided on this form will be used in evaluating the application for a permit. Routine Uses: This information may be shared with the Department of Justice and other federal, state, and local government agencies, and the public and may be made available as part of a public notice as required by Federal law. Submission of requested information is voluntary, however, if information is not provided the permit application cannot be evaluated nor can a permit be issued. One set of original drawings or good reproducible copies which show the location and character of the proposed activity must be attached to this application (see sample drawings and/or instructions) and be submitted to the District Engineer having jurisdiction over the location of the proposed activity. An application that is not completed in full will be returned.

(ITEMS 1 THRU 4 TO BE FILLED BY THE CORPS)

1. APPLICATION NO.	2. FIELD OFFICE CODE	3. DATE RECEIVED	4. DATE APPLICATION COMPLETE
--------------------	----------------------	------------------	------------------------------

(ITEMS BELOW TO BE FILLED BY APPLICANT)

5. APPLICANT'S NAME First - Gerry Middle - Last - Mirabile Company - Central Maine Power Company E-mail Address - gerry.mirabile@cmpco.com	8. AUTHORIZED AGENT'S NAME AND TITLE (agent is not required) First - Mark Middle - Last - Goodwin Company - Burns & McDonnell E-mail Address - magoodwin@burnsmcd.com
6. APPLICANT'S ADDRESS: Address- 83 Edison Drive City - Augusta State - ME Zip - 04336 Country - USA	9. AGENT'S ADDRESS: Address- 27 Pearl Street, 2nd Floor City - Portland State - ME Zip - 04101 Country - USA
7. APPLICANT'S PHONE NOs. w/AREA CODE a. Residence b. Business c. Fax (207) 626-9557	10. AGENTS PHONE NOs. w/AREA CODE a. Residence b. Business c. Fax (207) 517-8482

STATEMENT OF AUTHORIZATION

11. I hereby authorize, Mark Goodwin-Burns&McDonnl to act in my behalf as my agent in the processing of this application and to furnish, upon request, supplemental information in support of this permit application.



 SIGNATURE OF APPLICANT

9/25/2017

 DATE

NAME, LOCATION, AND DESCRIPTION OF PROJECT OR ACTIVITY

12. PROJECT NAME OR TITLE (see instructions) New England Clean Energy Connect (NECEC)	
13. NAME OF WATERBODY, IF KNOWN (if applicable) See attached.	14. PROJECT STREET ADDRESS (if applicable) Address See Sec. 1.0 Development Description of Site Law Applic.
15. LOCATION OF PROJECT Latitude: °N See attached. Longitude: °W See attached.	City - State - Zip -
16. OTHER LOCATION DESCRIPTIONS, IF KNOWN (see instructions) State Tax Parcel ID See attached. Municipality Section - Township - Range -	

17. DIRECTIONS TO THE SITE

See Section 1.0 Development Description of the Site Law application, attached.

18. Nature of Activity (Description of project, include all features)

A new HVDC transmission line, new transmission lines, and rebuild of existing transmission lines, with associated DC to AC converter station and STATCOM substation. See Section 1.0 Development Description of the Site Law application, attached.

19. Project Purpose (Describe the reason or purpose of the project, see instructions)

See Section 1.4 Needs Assessment of the Site Law application, attached.

USE BLOCKS 20-23 IF DREDGED AND/OR FILL MATERIAL IS TO BE DISCHARGED

20. Reason(s) for Discharge

Not applicable.

21. Type(s) of Material Being Discharged and the Amount of Each Type in Cubic Yards:

Type Amount in Cubic Yards	Type Amount in Cubic Yards	Type Amount in Cubic Yards
-------------------------------	-------------------------------	-------------------------------

Not applicable.

22. Surface Area in Acres of Wetlands or Other Waters Filled (see instructions)

Acres 4.70 acres of permanent wetland fill, 50.97 acres of temporary wetland fill

or

Linear Feet

23. Description of Avoidance, Minimization, and Compensation (see instructions)

See applicable sections of the attached Site Law and NRPA applications, attached.

24. Is Any Portion of the Work Already Complete? Yes No IF YES, DESCRIBE THE COMPLETED WORK

25. Addresses of Adjoining Property Owners, Lessees, Etc., Whose Property Adjoins the Waterbody (if more than can be entered here, please attach a supplemental list).

a. Address- See Abutter List- Exhibit 26-1 of the attached Site Law application.

City - State - Zip -

b. Address-

City - State - Zip -

c. Address-

City - State - Zip -

d. Address-

City - State - Zip -

e. Address-



City - State - Zip -

26. List of Other Certificates or Approvals/Denials received from other Federal, State, or Local Agencies for Work Described in This Application.

AGENCY	TYPE APPROVAL*	IDENTIFICATION NUMBER	DATE APPLIED	DATE APPROVED	DATE DENIED
MDEP	NRPA	n/a	9/27/2017		
MDEP	Site Law	n/a	9/27/2017		

* Would include but is not restricted to zoning, building, and flood plain permits

27. Application is hereby made for permit or permits to authorize the work described in this application. I certify that this information in this application is complete and accurate. I further certify that I possess the authority to undertake the work described herein or am acting as the duly authorized agent of the applicant.

_____ 9/25/2017 _____ 9.26.2017
 SIGNATURE OF APPLICANT DATE SIGNATURE OF AGENT DATE

The Application must be signed by the person who desires to undertake the proposed activity (applicant) or it may be signed by a duly authorized agent if the statement in block 11 has been filled out and signed.

18 U.S.C. Section 1001 provides that: Whoever, in any manner within the jurisdiction of any department or agency of the United States knowingly and willfully falsifies, conceals, or covers up any trick, scheme, or disguises a material fact or makes any false, fictitious or fraudulent statements or representations or makes or uses any false writing or document knowing same to contain any false, fictitious or fraudulent statements or entry, shall be fined not more than \$10,000 or imprisoned not more than five years or both.

17. DIRECTIONS TO THE SITE

See Section 1.0 Development Description of the Site Law application, attached.

18. Nature of Activity (Description of project, include all features)

A new HVDC transmission line, new transmission lines, and rebuild of existing transmission lines, with associated DC to AC converter station and STATCOM substation. See Section 1.0 Development Description of the Site Law application, attached.

19. Project Purpose (Describe the reason or purpose of the project, see instructions)

See Section 1.4 Needs Assessment of the Site Law application, attached.

USE BLOCKS 20-23 IF DREDGED AND/OR FILL MATERIAL IS TO BE DISCHARGED

20. Reason(s) for Discharge

Not applicable.

21. Type(s) of Material Being Discharged and the Amount of Each Type in Cubic Yards:

Type Amount in Cubic Yards	Type Amount in Cubic Yards	Type Amount in Cubic Yards
-------------------------------	-------------------------------	-------------------------------

Not applicable.

22. Surface Area in Acres of Wetlands or Other Waters Filled (see instructions)

Acres 4.70 acres of permanent wetland fill, 50.97 acres of temporary wetland fill

or

Linear Feet

23. Description of Avoidance, Minimization, and Compensation (see instructions)

See applicable sections of the attached Site Law and NRPA applications, attached.

24. Is Any Portion of the Work Already Complete? Yes No IF YES, DESCRIBE THE COMPLETED WORK

25. Addresses of Adjoining Property Owners, Lessees, Etc., Whose Property Adjoins the Waterbody (if more than can be entered here, please attach a supplemental list).

a. Address- See Abutter List- Exhibit 26-1 of the attached Site Law application.

City - State - Zip -

b. Address-

City - State - Zip -

c. Address-

City - State - Zip -

d. Address-

City - State - Zip -

e. Address-

City - State - Zip -

26. List of Other Certificates or Approvals/Denials received from other Federal, State, or Local Agencies for Work Described in This Application.

AGENCY	TYPE APPROVAL*	IDENTIFICATION NUMBER	DATE APPLIED	DATE APPROVED	DATE DENIED
MDEP	NRPA	n/a	9/27/2017		
MDEP	Site Law	n/a	9/27/2017		

* Would include but is not restricted to zoning, building, and flood plain permits

27. Application is hereby made for permit or permits to authorize the work described in this application. I certify that this information in this application is complete and accurate. I further certify that I possess the authority to undertake the work described herein or am acting as the duly authorized agent of the applicant.



 SIGNATURE OF APPLICANT DATE SIGNATURE OF AGENT DATE

The Application must be signed by the person who desires to undertake the proposed activity (applicant) or it may be signed by a duly authorized agent if the statement in block 11 has been filled out and signed.

18 U.S.C. Section 1001 provides that: Whoever, in any manner within the jurisdiction of any department or agency of the United States knowingly and willfully falsifies, conceals, or covers up any trick, scheme, or disguises a material fact or makes any false, fictitious or fraudulent statements or representations or makes or uses any false writing or document knowing same to contain any false, fictitious or fraudulent statements or entry, shall be fined not more than \$10,000 or imprisoned not more than five years or both.

Attachment B: Kennebec River Gorge Photosimulations

PHOTOSIMULATION 11: KENNEBEC GORGE Looking North, Moxie Gore, 3 Structure Option



Proposed Conditions: Panoramic view looking from north to east from near the picnic area on the Kennebec River, 1,400' +/- south of the proposed HVDC transmission line crossing. The top of one structure will be visible from this viewpoint at a distance of 1,530'. A forested buffer of approximately 550' will be maintained along the northwest shore between the shoreline and the closest structure. The conductors would be approximately 200' above the water level. Approximately eighteen marker balls will be placed on the shield wires and conductors above the Kennebec Gorge. Approximately twelve marker balls are visible in this photosimulation. See Appendix B: Study Area Photographs for additional images.

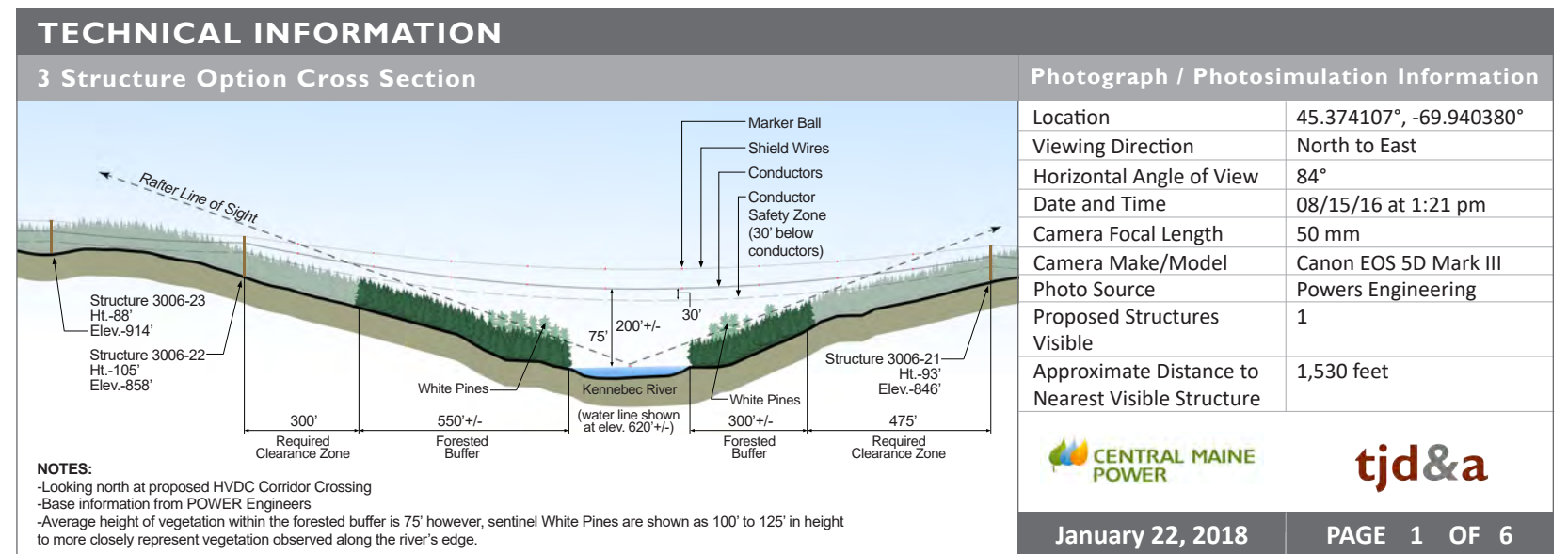
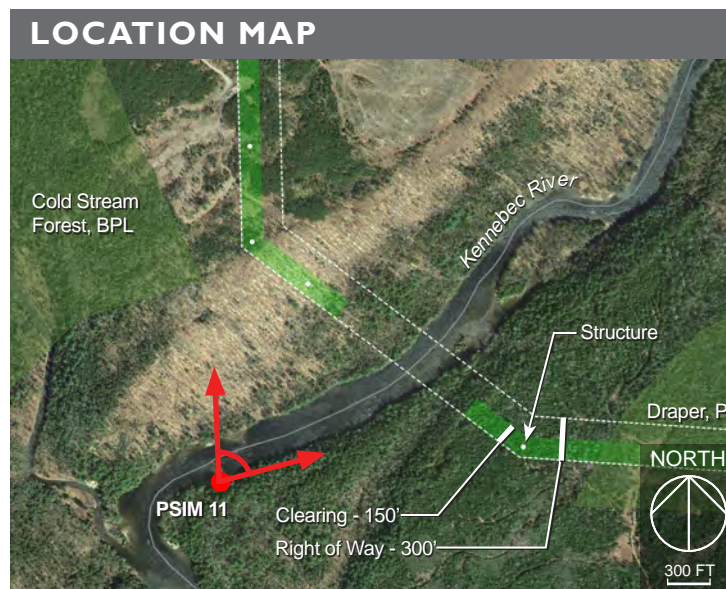

PHOTOSIMULATION 11: KENNEBEC GORGE Looking North, Moxie Gore, 3 Structure Option

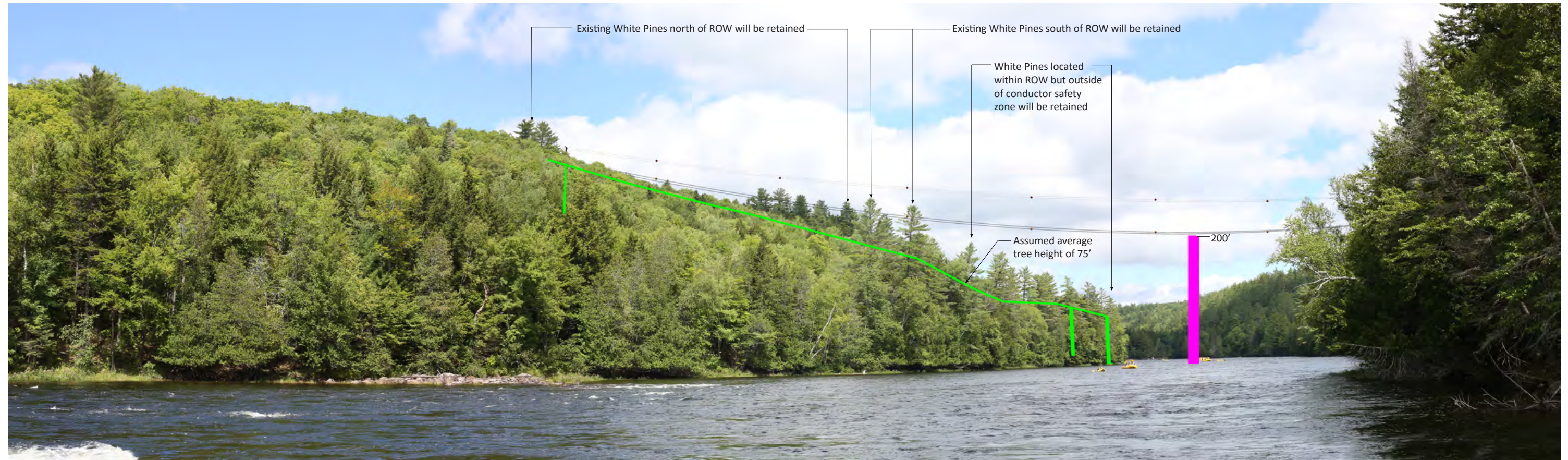

Proposed Conditions: Panoramic view looking from north to east from near the picnic area on the Kennebec River, 1,400'+/- south of the proposed HVDC transmission line crossing. The top of one structure will be visible from this viewpoint at a distance of 1,530'. A forested buffer of approximately 550' will be maintained along the northwest shore between the shoreline and the closest structure. The conductors would be approximately 200' above the water level. Approximately eighteen marker balls will be placed on the shield wires and conductors above the Kennebec Gorge. Approximately twelve marker balls are visible in this photosimulation. See Appendix B: Study Area Photographs for additional images.

Scale Reference from 3D Model: The green lines represent an assumed average height of 75' for existing trees. Several white pines along the river's edge appear taller than 75' in height. The magenta line represents 200' from the water surface directly beneath the proposed conductors (lowest point in conductor sag).

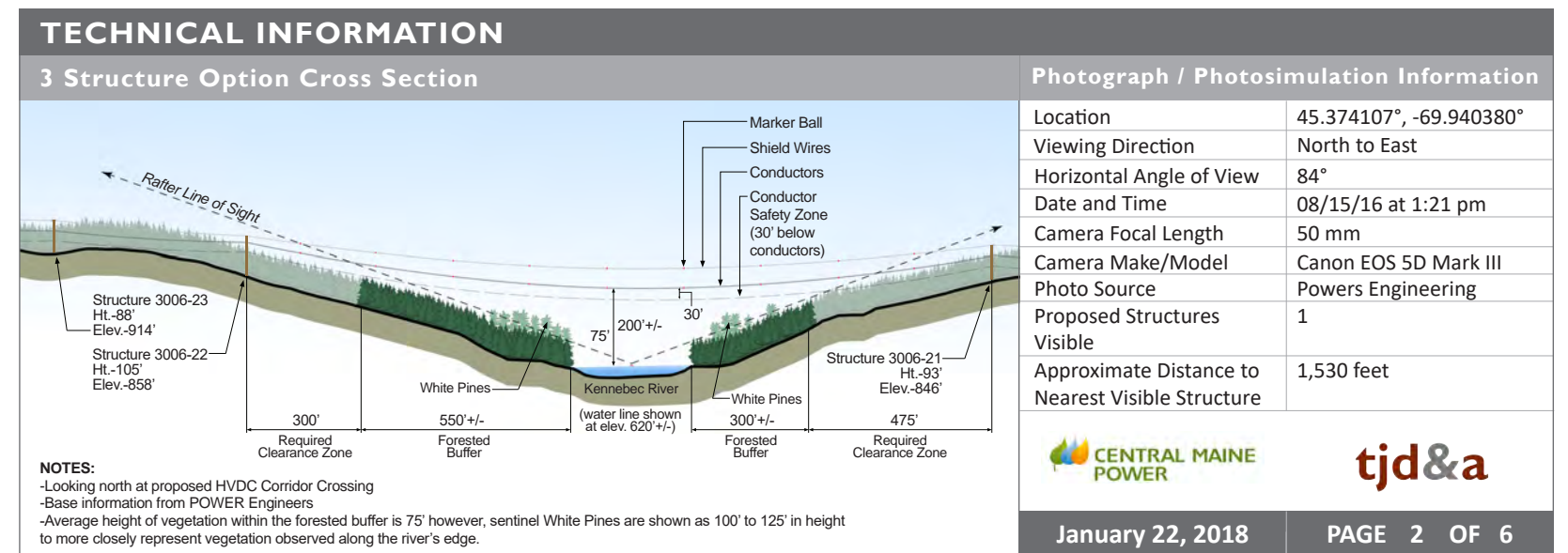
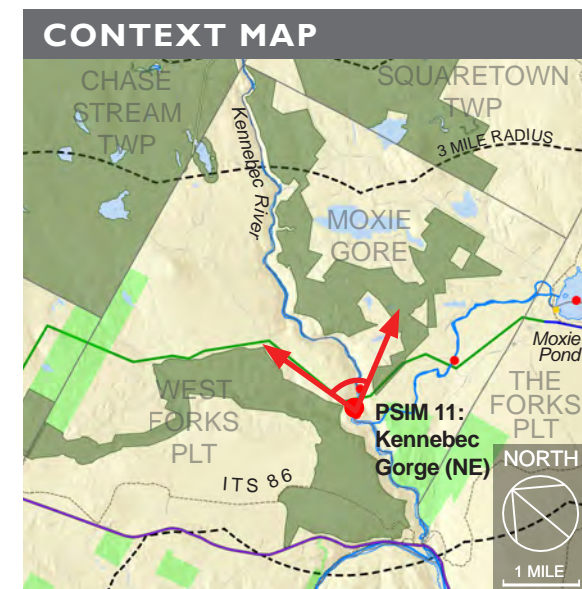
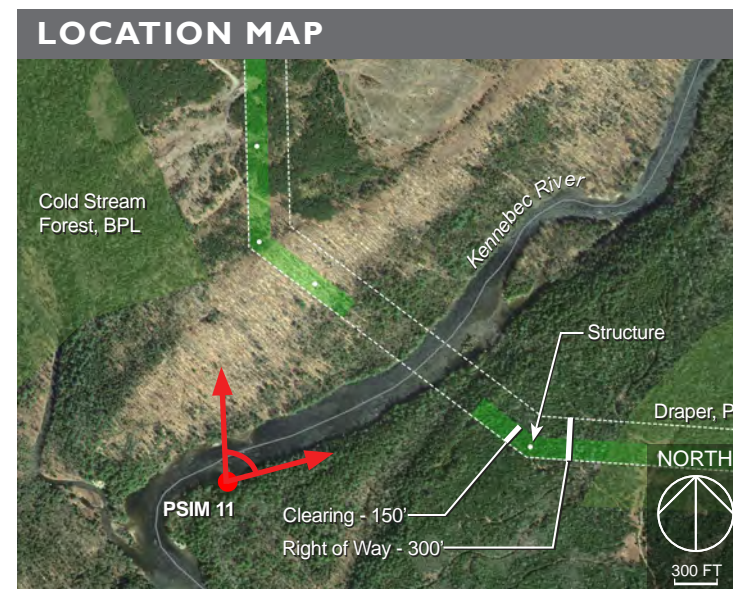



Existing Conditions: Normal view looking northeast from the Kennebec Gorge.

PHOTOSIMULATION I I A: KENNEBEC GORGE Looking Northeast, Moxie Gore, 3 Structure Option



Proposed Conditions: Normal view looking northeast from near the picnic area on the Kennebec River 1,400' +/- south of the proposed HVDC transmission line crossing. The top of one structure will be visible from this viewpoint at a distance of 1,530'. The lowest point of the conductors would be approximately 200' above the water level. Approximately eighteen marker balls will be placed on the shield wires and conductors above the Kennebec Gorge.



Existing Conditions: Normal view looking northeast from the Kennebec Gorge.

PHOTOSIMULATION I 1B: KENNEBEC GORGE Looking Northeast, Moxie Gore, 3 Structure Option



Proposed Conditions: Normal view looking northeast from near the picnic area on the Kennebec River 1,400'+/- south of the proposed HVDC transmission line crossing. The lowest point of the conductors would be approximately 200' above the water level. Approximately eighteen marker balls will be placed on the shield wires and conductors above the Kennebec Gorge.

PHOTOSIMULATION 32: KENNEBEC GORGE PICNIC AREA Looking Southwest, 3 Structure Option

MODEL OVERLAY REFERENCE

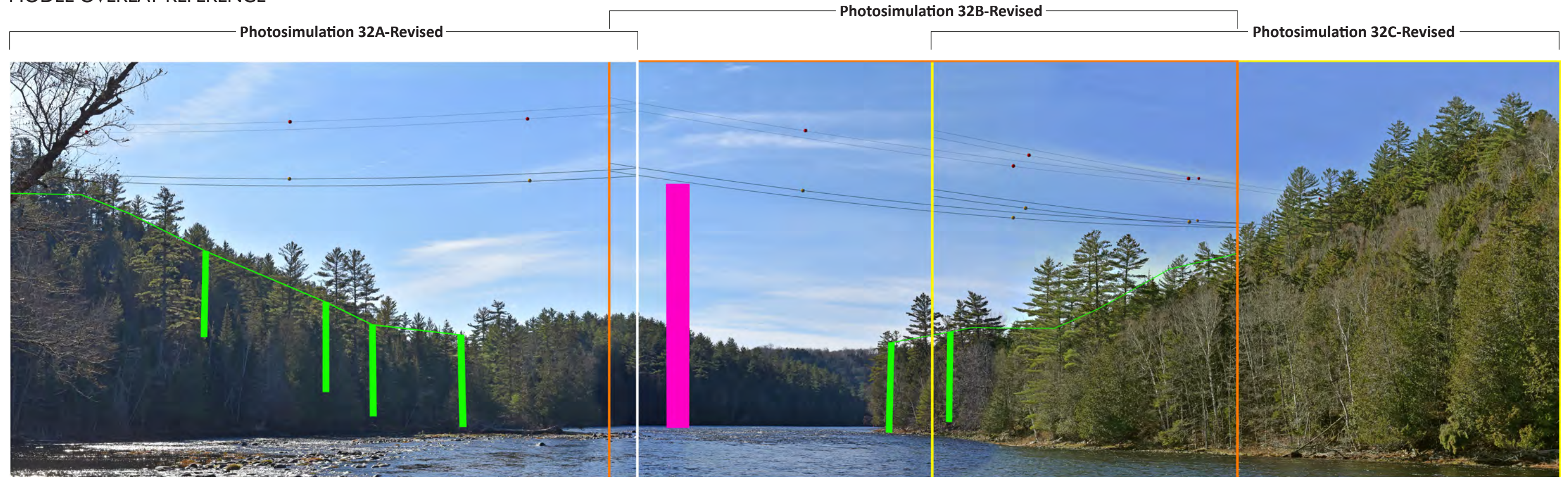

Proposed Conditions: Panoramic view looking from south to southwest from a point 750' +/- north of the proposed HVDC transmission line crossing of the Kennebec River near a rafting company picnic area. The closest structure, screened by vegetation in this view, is 850' +/- to the south. Conductors, approximately 200' above the river, will be visible to recreational boaters for approximately 1,600' approaching the crossing. Marker balls will be visible on the shield wires and conductors.

3D MODEL Scale Reference: This panoramic diagram shows the 'normal' view output from the modeling software over the merged panoramic image. Due to the relatively close (750') distance of the viewer to the proposed conductors, the lines appear similar to a "fish eye" lens (i.e. the conductors seem wider and higher over the middle of the river). In the photosimulation submitted on 12/12/17, the location of the conductors were adjusted to appear as continuous lines which resulted in the lines appearing to be approximately 25' lower than they would appear from this viewpoint. The proposed Project visibility is best assessed by reviewing the normal views because there is no distortion, see the updated images included on the following pages. Also included in the image above are scale references from the 3D Model; the magenta line represents 200' from the water surface directly beneath the proposed conductors (lowest point of conductor sag) and the green lines represent an assumed average height of 75' for existing trees within the Project corridor. Several white pines along the river's edge appear taller than 75' in height.

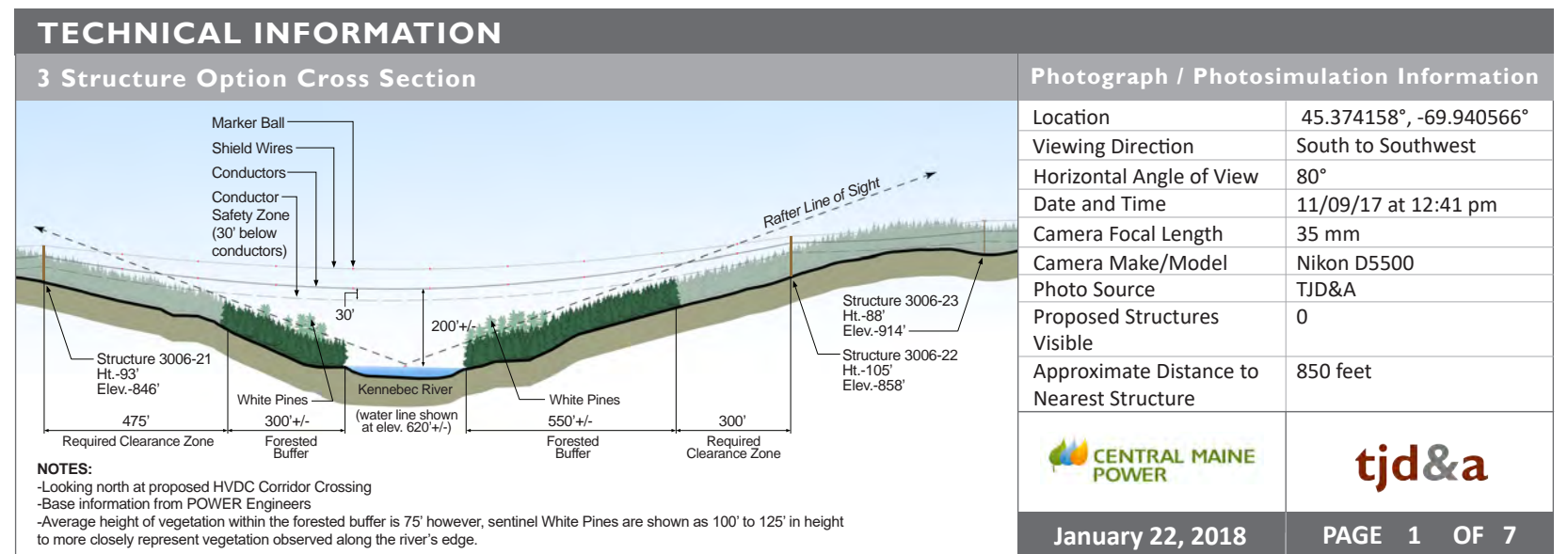
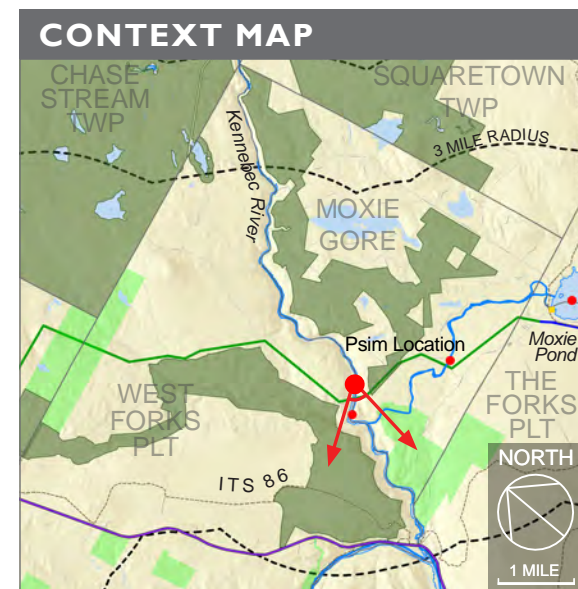
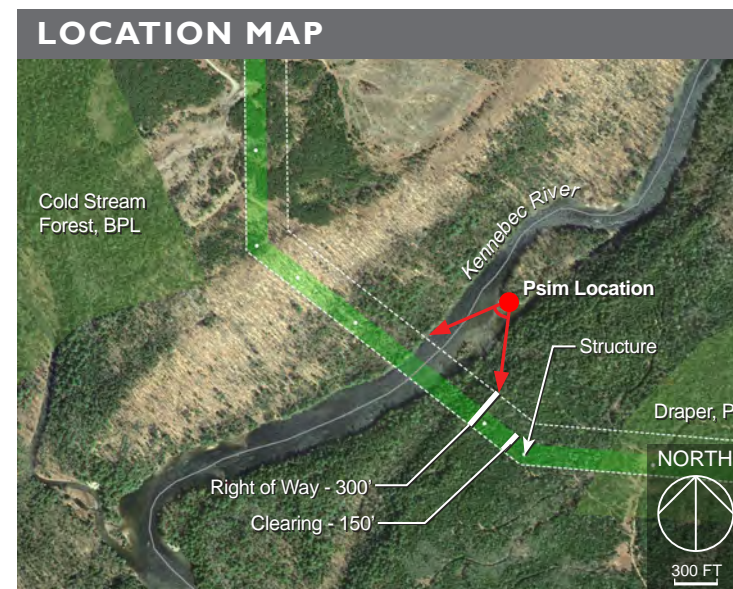



Existing Conditions: Normal view looking south from a picnic area on the Kennebec River.



Proposed Conditions: Normal view looking south from a point 750' +/- north of the proposed HVDC transmission line crossing of the Kennebec River near a picnic area. The closest structure, screened by vegetation in this view, is 850' +/- to the south. Conductors over the river will be visible to recreational boaters for approximately 1,600' approaching the crossing.



Existing Conditions: Normal view looking southwest from a picnic area on the Kennebec River.



Proposed Conditions: Normal view looking southwest from a point 750' +/- north of the proposed HVDC transmission line crossing of the Kennebec River near picnic area. The closest structure, screened by vegetation in this view, is 850' +/- to the south. Conductors over the river will be visible to recreational boaters for approximately 1,600' approaching the crossing.



Existing Conditions: Normal view looking southwest from a picnic area on the Kennebec River.



Proposed Conditions: Normal view looking southwest from a point 750' +/- north of the proposed HVDC transmission line crossing of the Kennebec River near picnic area. The closest structure, screened by vegetation in this view, is 850' +/- to the south. Conductors over the river will be visible to recreational boaters for approximately 1,600' approaching the crossing.

Attachment C: Preliminary 2018 Field Survey Schedules

NECEC 2018 Preliminary Field Survey Schedule



Historical Resources Surveys	Start Date	End Date	Calendar Days
1. Reconnaissance Field Survey	4/12/2018	4/24/2018	12
2. Draft Addendum Report and Phase I Archaeology and Intensive Architectural History SOW to MHPC	4/24/2018	5/15/2018	21
3. MHPC Review and Approval of Phase 1/ Intensive SOW by MHPC	5/15/2018	6/15/2018	30
4. Phase I Archaeology and Intensive Architecture Field Survey	6/15/2018	7/15/2018	30
5. Draft Phase I Archaeology and Intensive Architecture Survey Report to MHPC	7/15/2018	8/15/2018	30
6. MHPC Review and Approval of NRHP Evaluation SOW	8/15/2018	9/15/2018	30
7. Phase II Archaeological Investigations and Architectural History Evaluation Fieldwork/Research	9/15/2018	10/15/2018	30
8. NRHP Eligibility Evaluation Report to MHPC	11/1/2018	12/15/2018	45
9. Memorandum of Agreement Execution		12/31/2018	

Rare Plant Surveys	Start Date	End Date	Calendar Days
1. Desktop Review Period and Field Survey SOW Identification in Coordination with MNAP	3/28/2018	5/28/2018	60
2. Early Summer Field Survey	5/28/2018	6/27/2018	30
3. Late Summer Field Survey	8/1/2018	8/31/2018	30
4. Report Preparation and Review Period	9/1/2018	9/15/2018	15
5. Final Report Deliverable		9/15/2018	

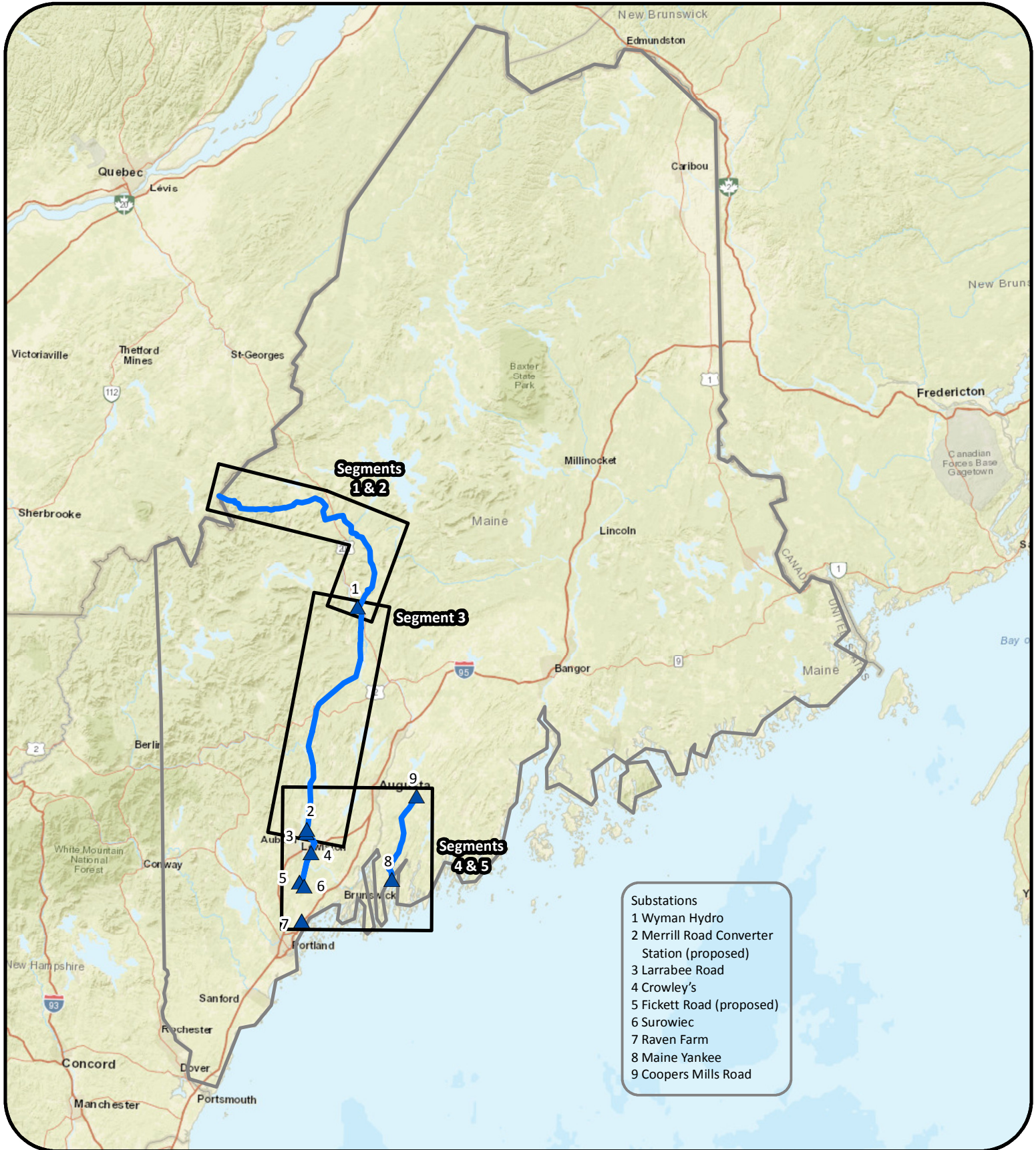
**Attachment D: Master Plan and Index Maps
Natural Resource Map Example
Representative Cross Section
Border Crossing Plan**



Legend

-  NECEC Project Route
-  Substation



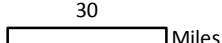

**New England
Clean Energy
Connect**

 **CENTRAL MAINE
POWER**

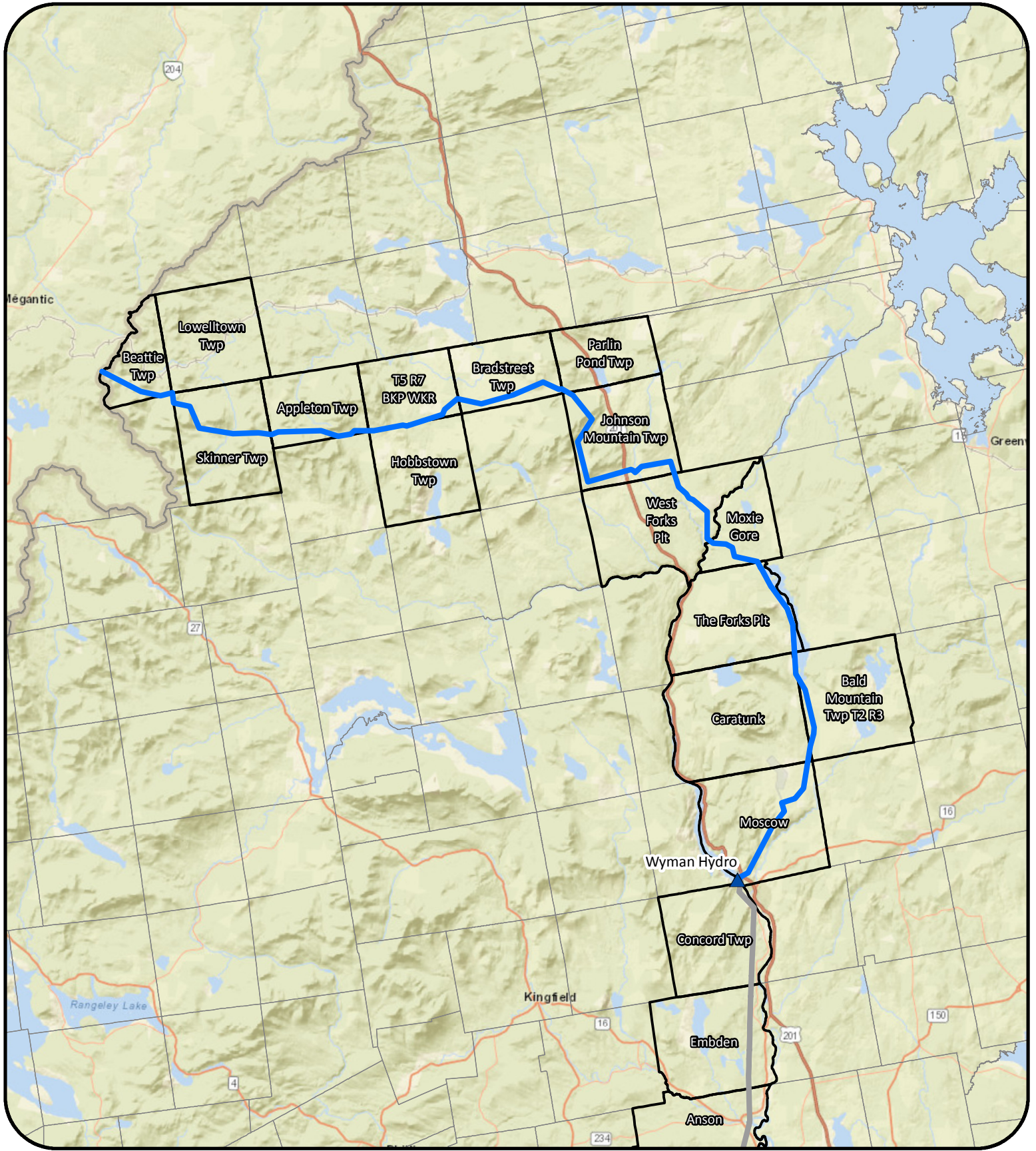

Legend

- Segments 1 & 2
- Other Segment
- ▲ Substation

5

 Miles

**New England
Clean Energy
Connect
Segments 1 & 2**

**CENTRAL MAINE
POWER**

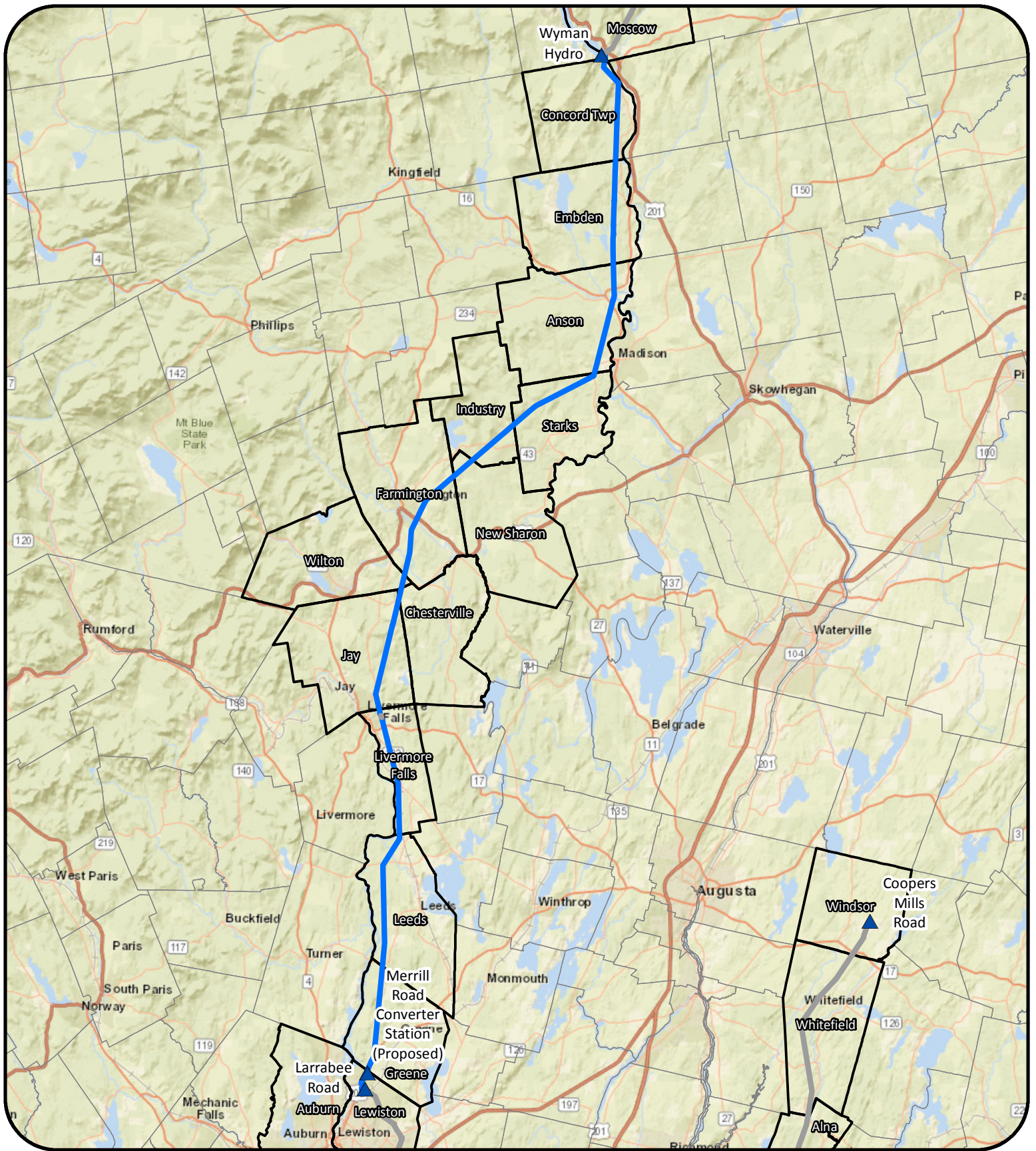

Legend

- Segment 3
- Other Segment
- ▲ Substation



**New England
Clean Energy
Connect
Segment 3**

 **CENTRAL MAINE
POWER**

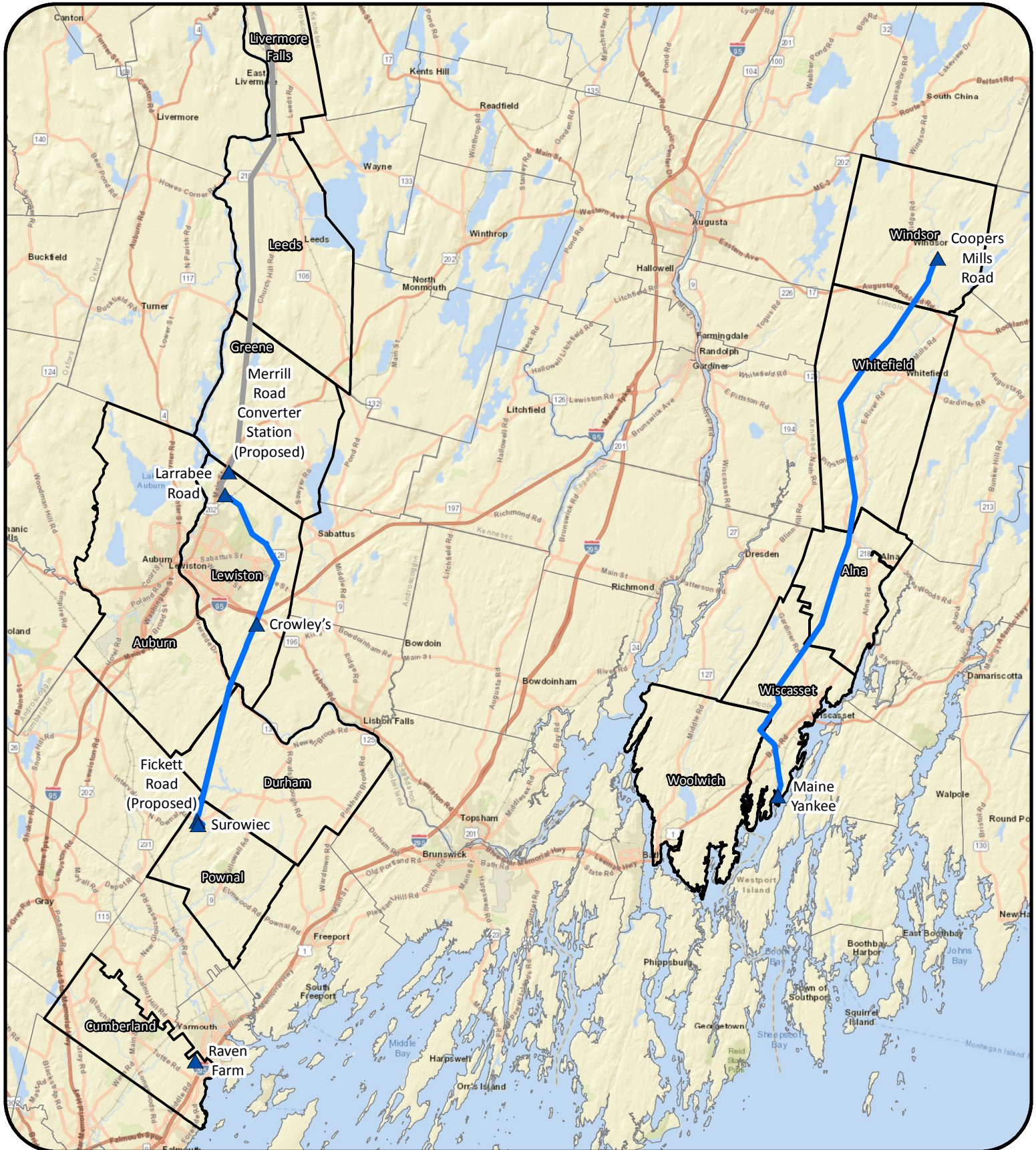

Legend

- ▬ Segments 4 & 5
- ▬ Other Segment
- ▲ Substation

4 Miles

**New England
Clean Energy
Connect
Segments 4 & 5**

**CENTRAL MAINE
POWER**

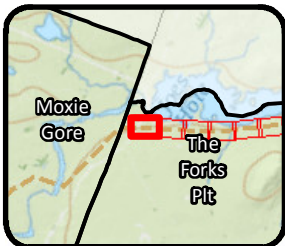
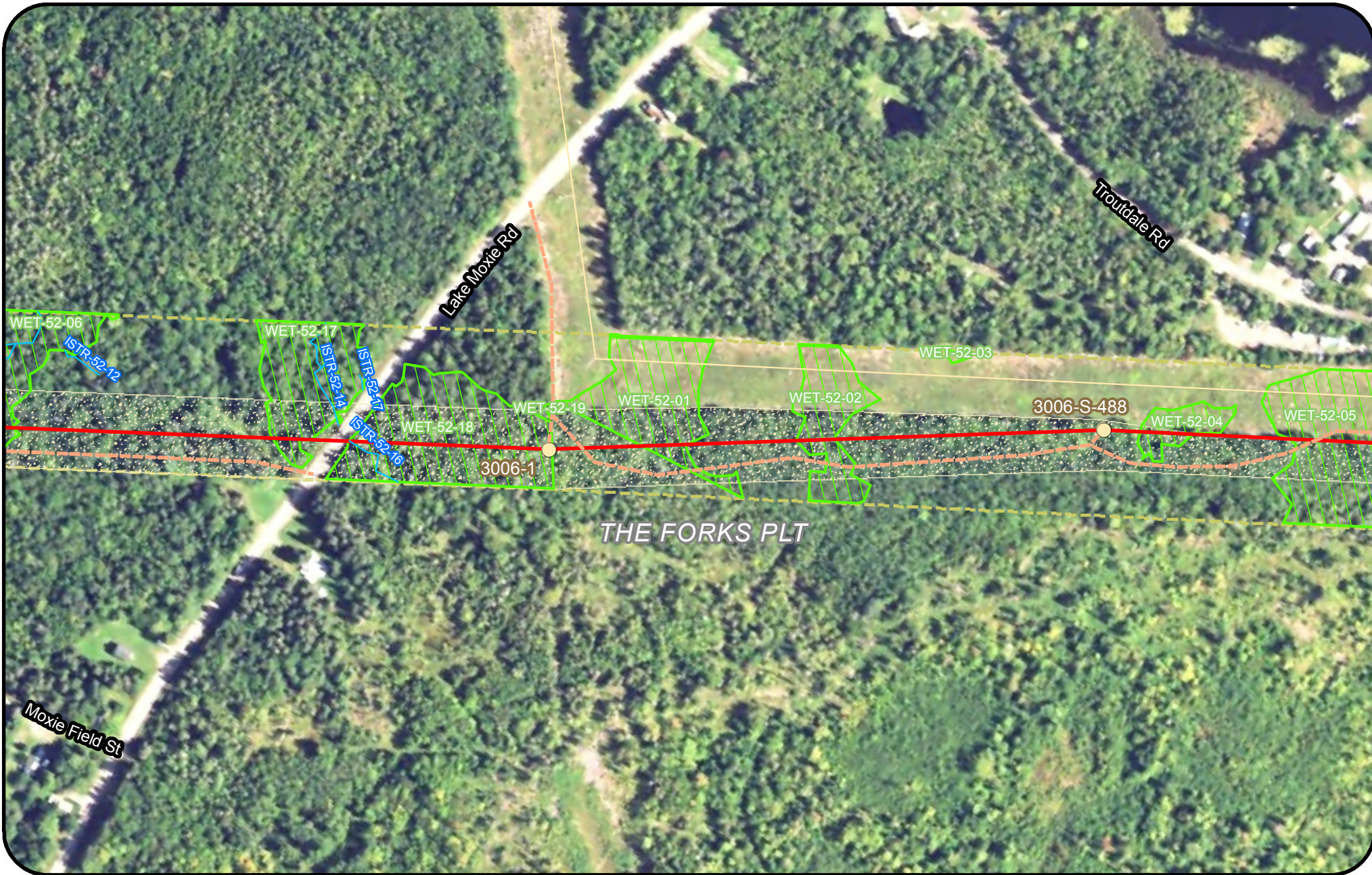

- | | | | |
|---------------------------------|----------------------------|--|---------------------------------|
| Clearing Limits | Proposed Structure | SVP/ PSVP | Waterfowl Wading Habitat (IWWH) |
| CMP Ownership / Easement Extent | Existing Structure | ABA | SVP and PSVP Buffer (250') |
| Town Boundary | Existing Substation | NVP | Substation Limit of Disturbance |
| Project Centerline | Proposed Converter Station | T and E Species | |
| Existing Transmission Line | Stream | Bald Eagle Nest | |
| Proposed Access Road | Wetland | Deer Wintering Area (DWA) | |
| | Rare Plant | Tidal Waterfowl Wading Bird Habitat (TWWH) | |

New England Clean Energy Connect
 Natural Resource Maps
 Segment 2
 250

CENTRAL MAINE POWER

**Representative Cross Section
from Quebec Border to
The Forks Plantation**

EXISTING

**PRELIMINARY
NOT FOR CONSTRUCTION**



LOOKING FROM QUEBEC BORDER TOWARDS WYMAN HYDRO SS
(APPROX. 53.5 MILES)

NOTE:
ADDITIONAL R.O.W. SECURED
TO ACCOMMODATE FUTURE
TRANSMISSION LINES.

PROPOSED

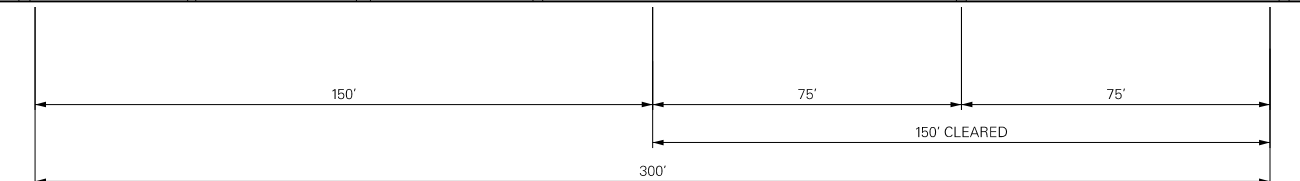
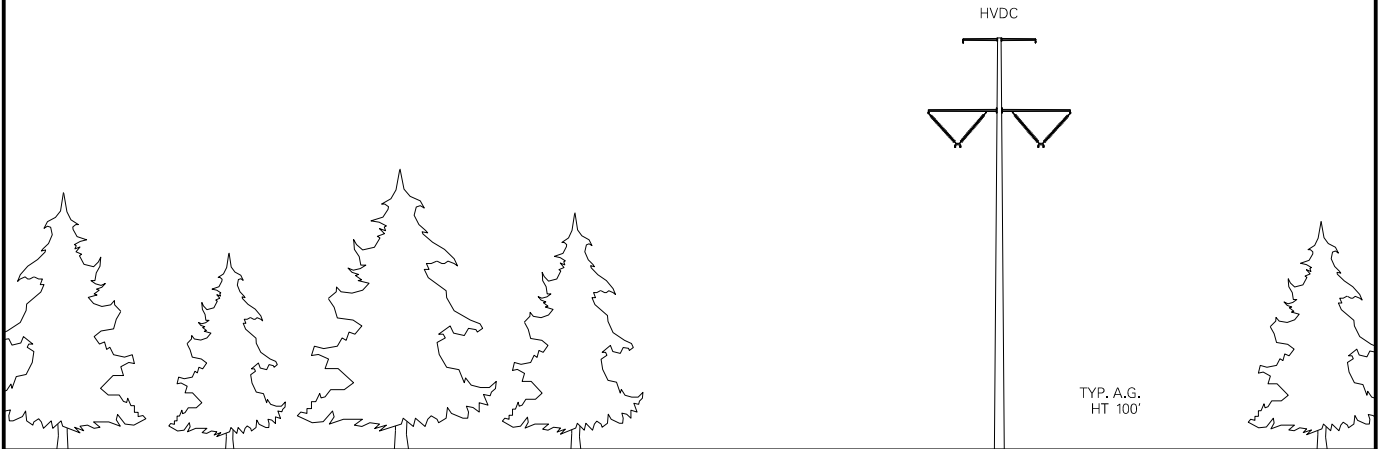

LOOKING FROM QUEBEC BORDER TOWARDS WYMAN HYDRO SS
(APPROX. 53.5 MILES)

THIS DRAWING SHALL
BE REVISED ON THE
CADD SYSTEM ONLY

-DRAFT- FOR REVIEW ONLY				S222 POLE 95 TO QUEBEC BORDER					
ENG. CONTRACTOR				NEW ENGLAND CLEAN ENERGY CONNECT					
				EXISTING AND PROPOSED R.O.W.					
				SEGMENT 1					
				CHECKED		DESIGNED JAR		DATE 3/2/17	
				CRM		DRAWN SCF		APPR.	
				4/11/17				SEGMENT I	
1	ISSUED FOR RFP RESPONSE		9/19/17	PEI					
NO.	REVISION	DATE	BY	SCALE	NTS	CENTRAL MAINE POWER		SHEET NECEC-I	

**Representative Cross Section
from The Forks Plantation to
Moscow**

EXISTING

**PRELIMINARY
NOT FOR CONSTRUCTION**

***Some areas may differ**

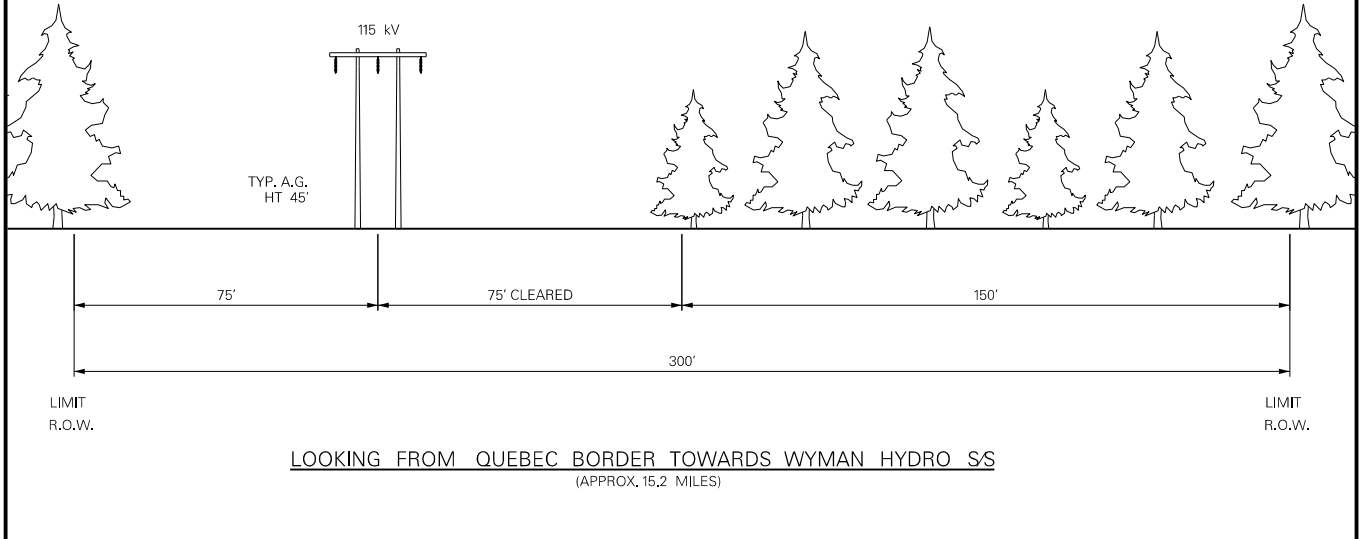

PROPOSED

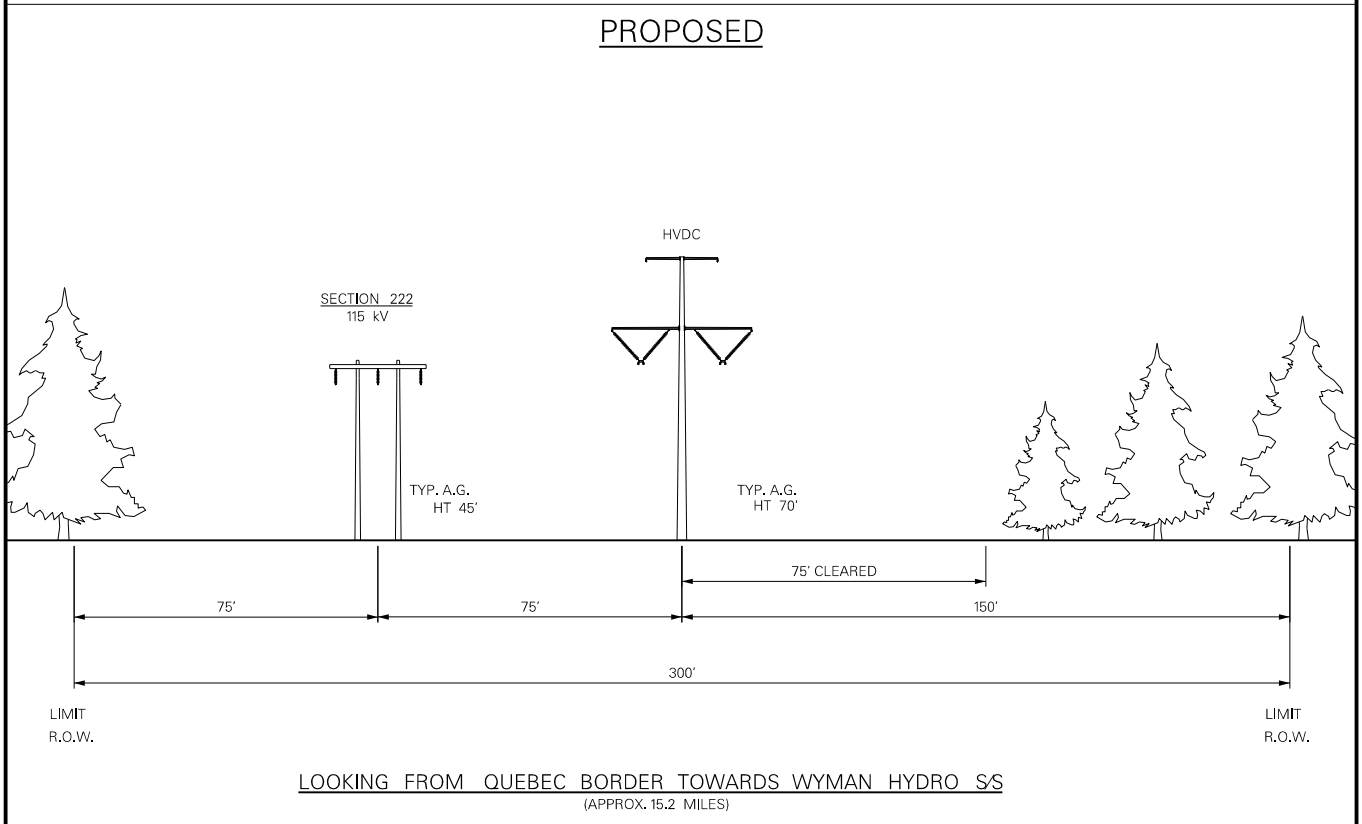

THIS DRAWING SHALL BE REVISED ON THE CADD SYSTEM ONLY

-DRAFT- FOR REVIEW ONLY				S222 POLE 95 TO S222 POLE 178					
ENG. CONTRACTOR				NEW ENGLAND CLEAN ENERGY CONNECT					
				EXISTING AND PROPOSED R.O.W.					
				SEGMENT 2					
				CHECKED		DESIGNED JAR		DATE 3/2/17	
2		REVISED STRUCTURE HEIGHTS		CRM		4/11/17		DRAWN SCF	
1		ISSUED FOR RFP RESPONSE						APPR.	
NO.		REVISION		DATE		BY			

**Representative Cross Section
from Moscow to Jay**

EXISTING

**PRELIMINARY
NOT FOR CONSTRUCTION**

***Some areas may differ**

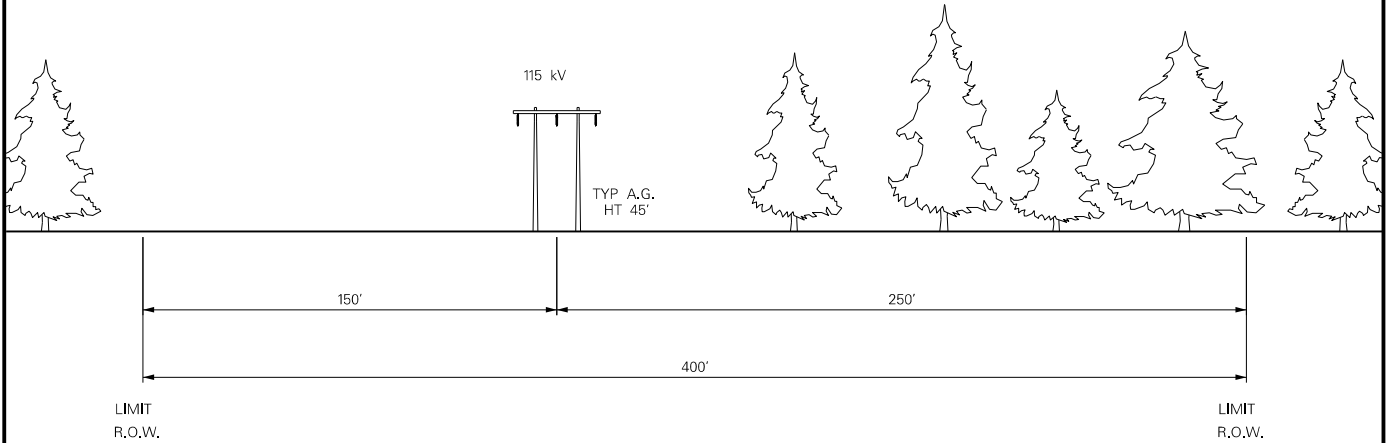

LOOKING FROM WYMAN HYDRO S/S TOWARDS MERRILL S/S
(APPROX. 25.2 MILES)

PROPOSED

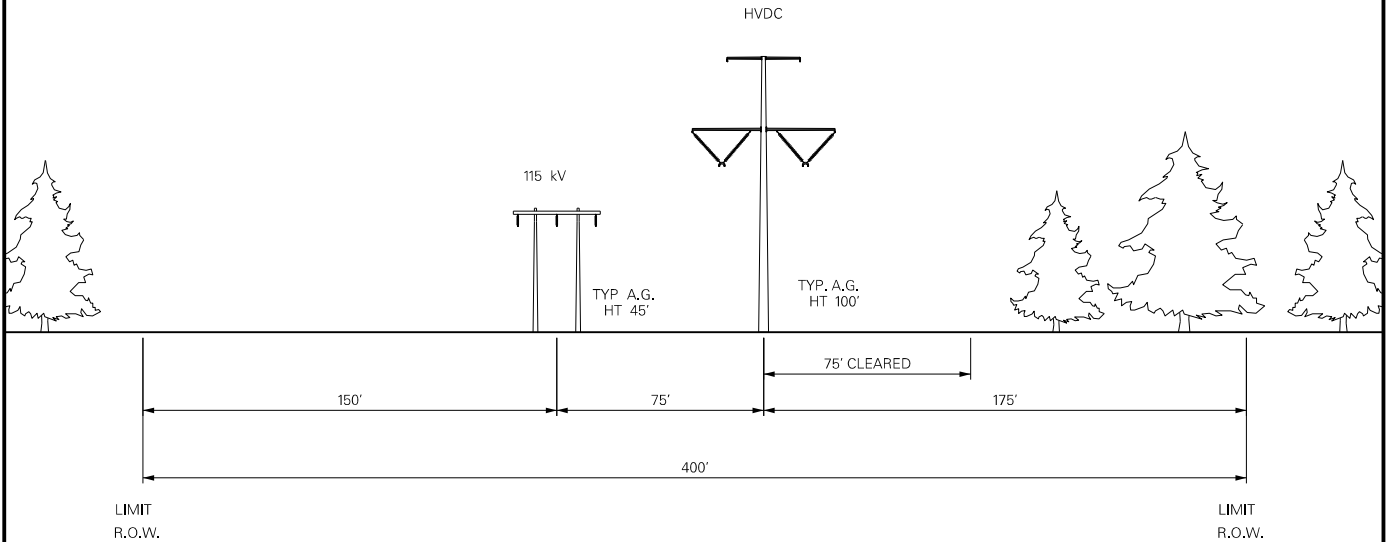

LOOKING FROM WYMAN HYDRO S/S TOWARDS MERRILL S/S
(APPROX. 25.2 MILES)

THIS DRAWING SHALL
BE REVISED ON THE
CADD SYSTEM ONLY

-DRAFT-
FOR REVIEW ONLY

STARKE S/S TO S278 POLE 330

ENG. CONTRACTOR

NEW ENGLAND CLEAN ENERGY CONNECT
EXISTING AND PROPOSED R.O.W.
SEGMENT 3

		//	
		//	
		//	
		//	
1	ISSUED FOR RFP RESPONSE	9/19/17	PEI

CHECKED
CRM 4/11/17

DESIGNED JAR DATE 3/2/17
DRAWN SCF APPR.

SEGMENT 3

NO. REVISION DATE BY SCALE NTS



SHEET NECEC-8

**Representative Cross Section
from Livermore Falls to
Merrill Rd in Lewiston**

***Some areas may differ**

EXISTING

**PRELIMINARY
NOT FOR CONSTRUCTION**

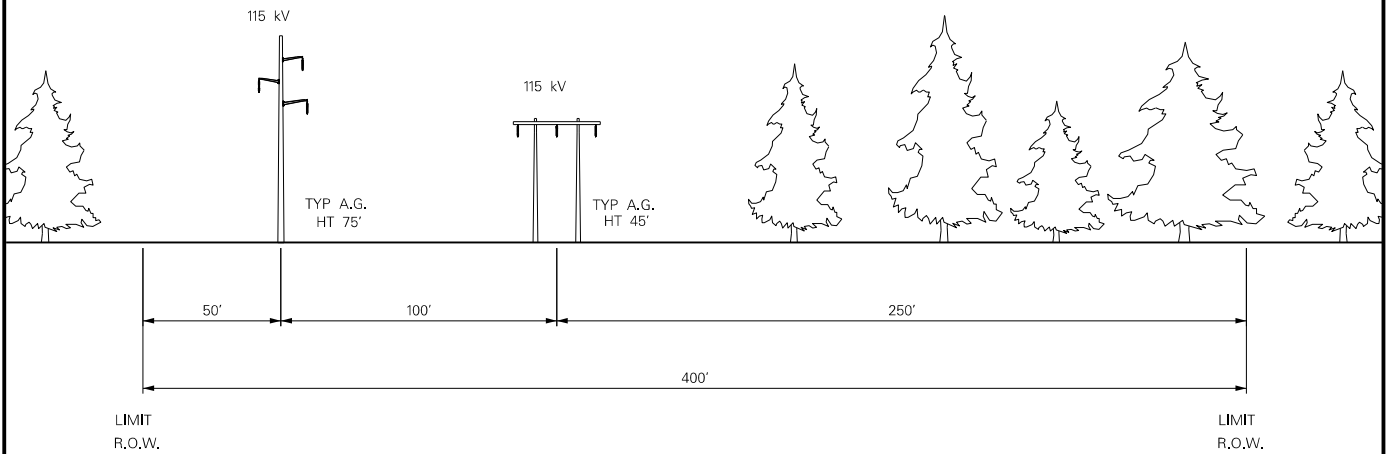

LOOKING FROM WYMAN HYDRO SS TOWARDS MERRILL SS
(APPROX. 17.8 MILES)

PROPOSED

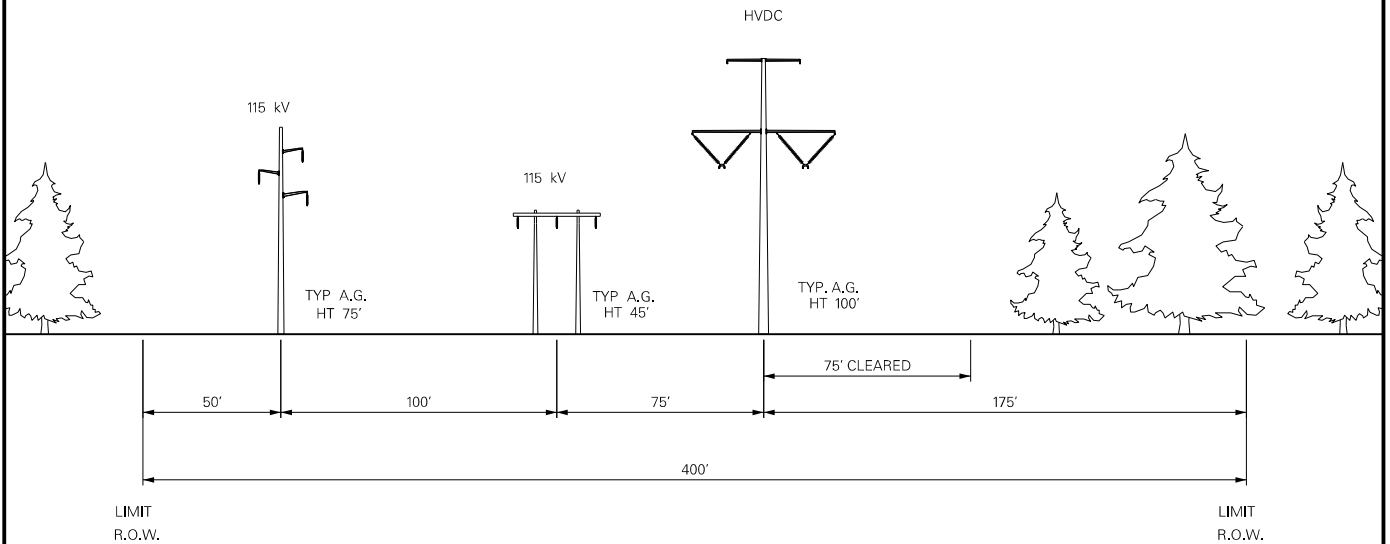

LOOKING FROM WYMAN HYDRO SS TOWARDS MERRILL SS

THIS DRAWING SHALL
BE REVISED ON THE
CADD SYSTEM ONLY

-DRAFT-
FOR REVIEW ONLY

S251 POLE 5 TO S251 POLE 56

ENG. CONTRACTOR

NEW ENGLAND CLEAN ENERGY CONNECT
EXISTING AND PROPOSED R.O.W.
SEGMENT 3

		//	
		//	
		//	
		//	
1	ISSUED FOR RFP RESPONSE	9/19/17	PEI

CHECKED
CRM 4/11/17

DESIGNED JAR DATE 3/2/17
DRAWN SCF APPR.

SEGMENT 3

NO. REVISION DATE BY SCALE NTS



SHEET NECEC-12

**Representative Cross Section
from Lewiston to Pownal**

EXISTING

**PRELIMINARY
NOT FOR CONSTRUCTION**

***Some areas may differ**

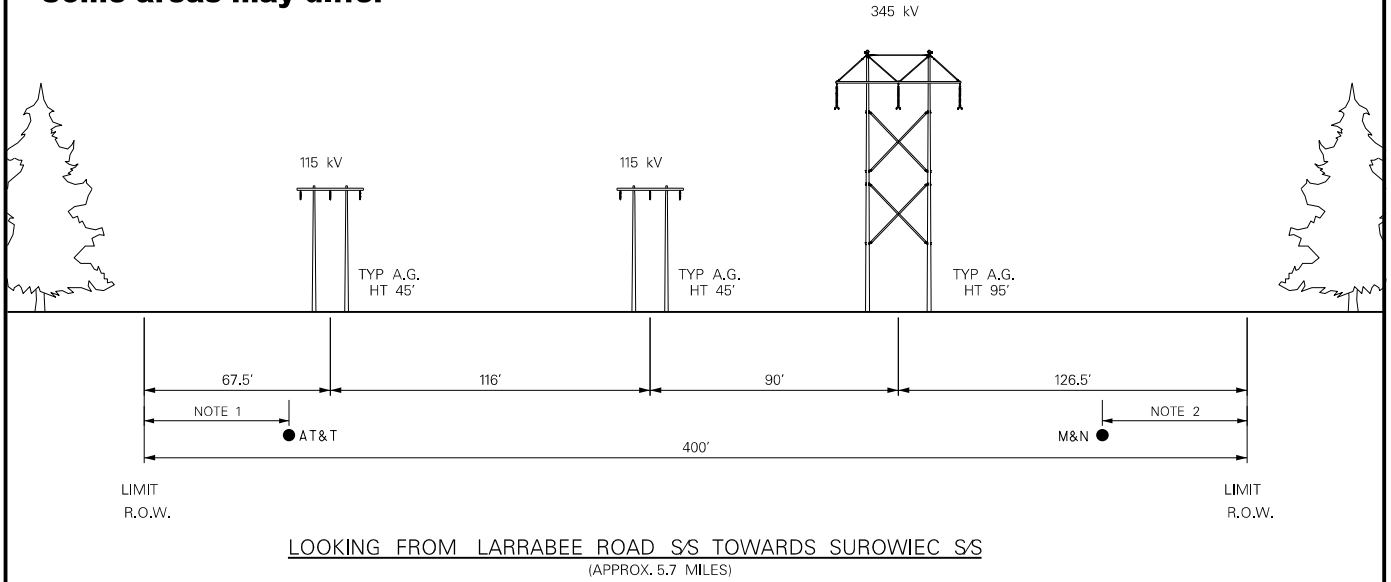

PROPOSED

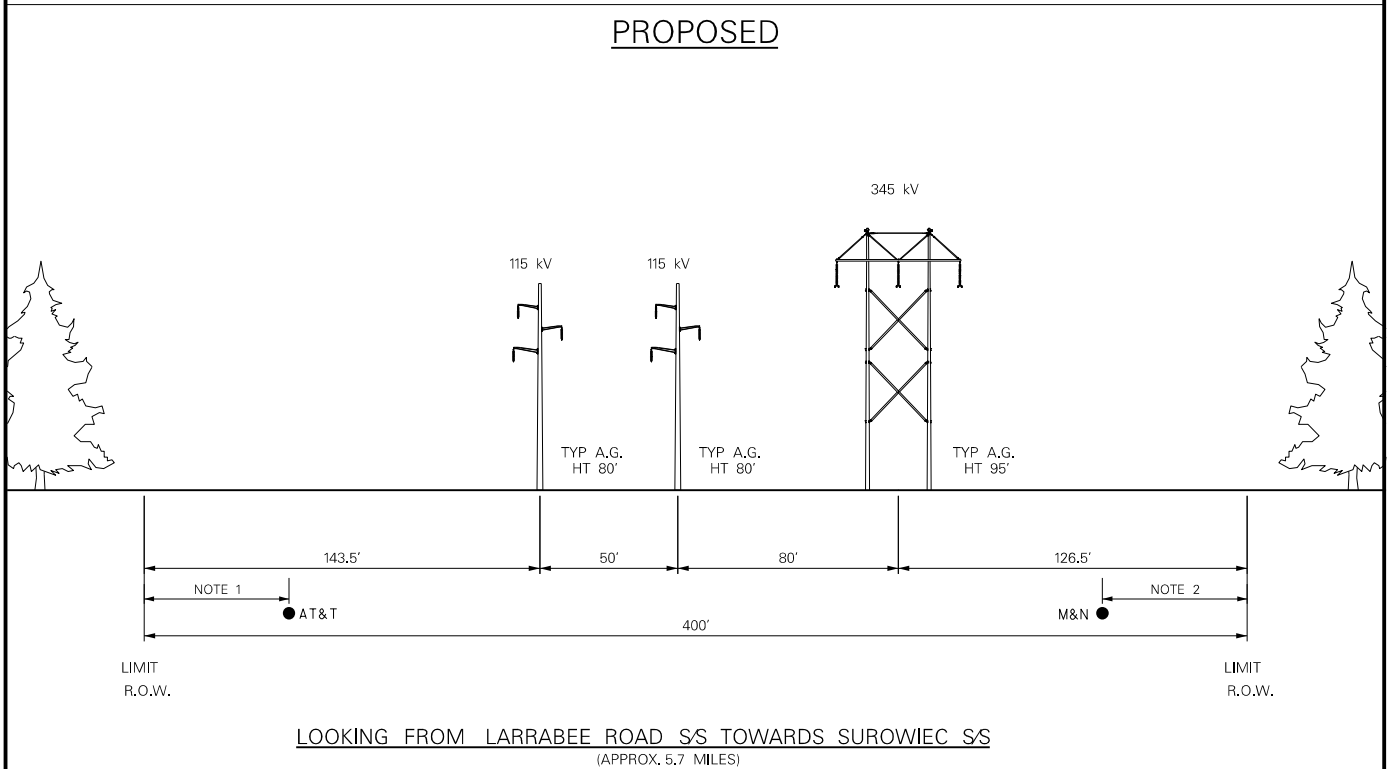

THIS DRAWING SHALL BE REVISED ON THE CADD SYSTEM ONLY

-DRAFT- FOR REVIEW ONLY				SECTION 3026		POLE 62 TO 73		STA 361+00 TO 420+44.56	
ENG. CONTRACTOR				NEW ENGLAND CLEAN ENERGY CONNECT					
				EXISTING AND PROPOSED R.O.W.					
				SEGMENT 4					
				CHECKED		DESIGNED CRM		DATE 4/11/17	
				CRM		4/11/17		DRAWN SCF	
								APPR.	
1		ISSUED FOR RFP RESPONSE		9/19/17		PEI		SEGMENT 4	
NO.		REVISION		DATE		BY			
				SCALE		NTS		SHEET S4-II	



**Representative Cross Section
from Windsor to Wiscasset**

***Some areas may differ**

EXISTING

**PRELIMINARY
NOT FOR CONSTRUCTION**

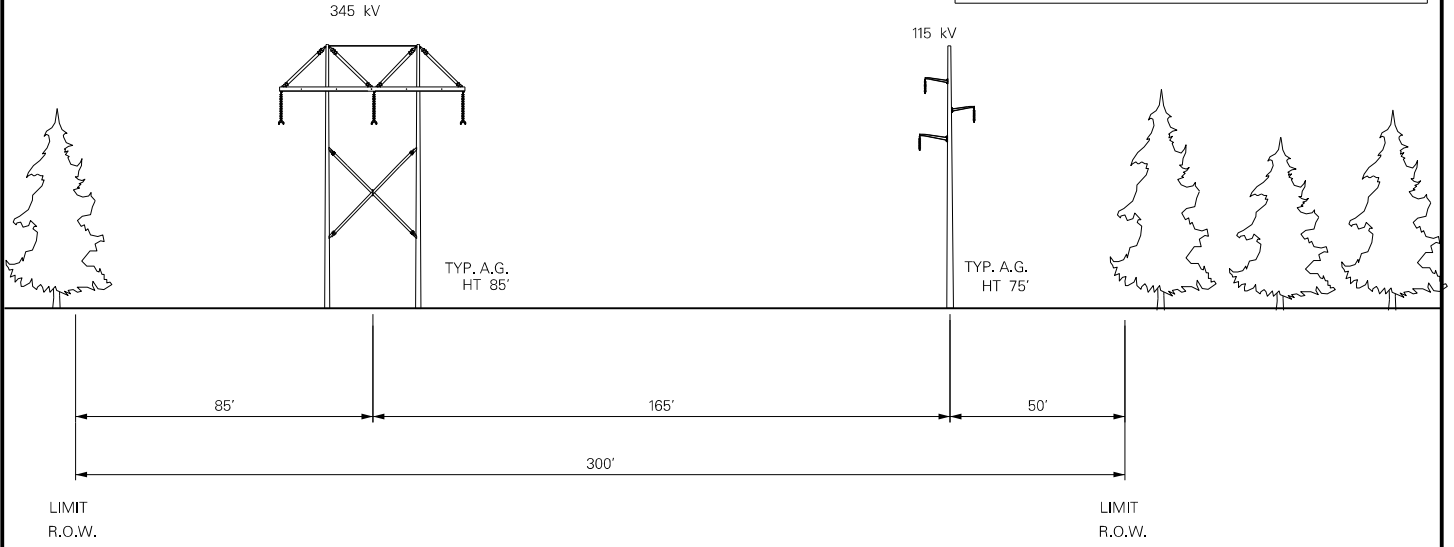

LOOKING FROM MAINE YANKEE SS TOWARDS COOPERS MILLS ROAD SS
(APPROX. 17.2 MILES)

PROPOSED

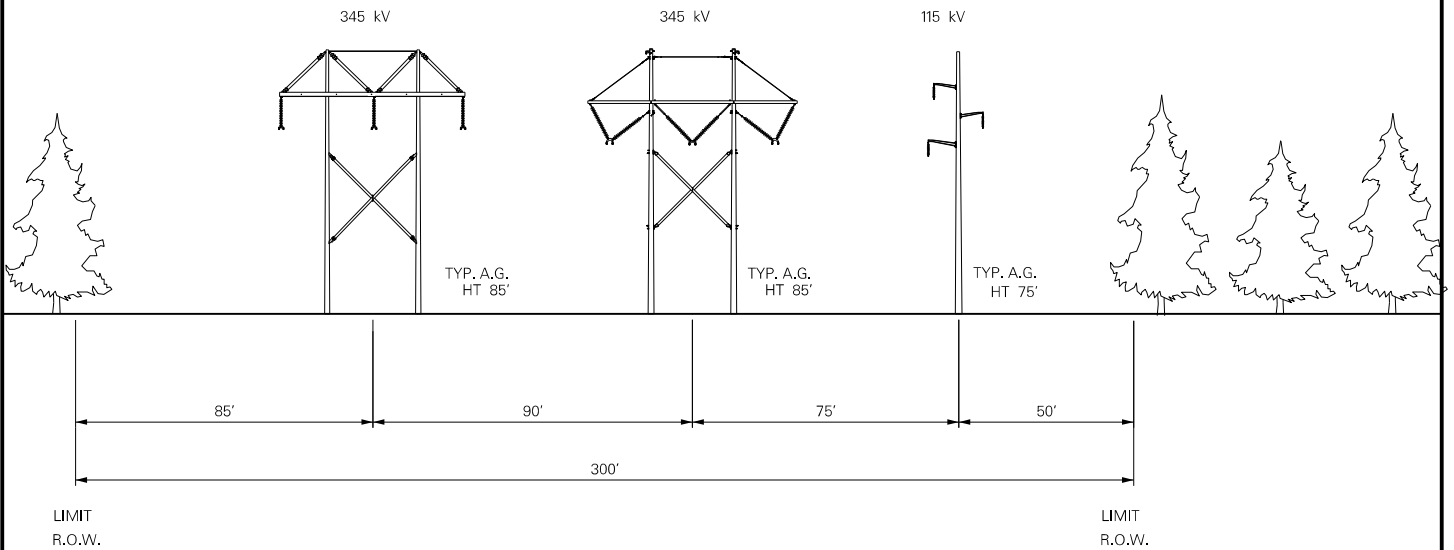

LOOKING FROM MAINE YANKEE SS TOWARDS COOPERS MILLS ROAD SS
(APPROX. 17.2 MILES)

**-DRAFT-
FOR REVIEW ONLY**

SECTION 392

POLE 64 TO 214

STA. 434+35 TO 1342+37

**NEW ENGLAND CLEAN ENERGY CONNECT
EXISTING AND PROPOSED R.O.W.
SEGMENT 5**

ENG. CONTRACTOR			
		//	
		//	
		//	
		//	
		//	
1	ISSUED FOR RFP RESPONSE	9/19/17	PEI
NO.	REVISION	DATE	BY

CHECKED		DESIGNED CRM	DATE 4/10/17
CRM	4/11/17	DRAWN SCF	APPR.
SCALE		NTS	

SEGMENT 5



SHEET S5-9

THIS DRAWING SHALL
BE REVISED ON THE
CADD SYSTEM ONLY

CANADA

MAINE / US

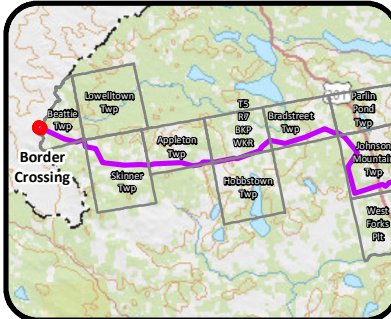
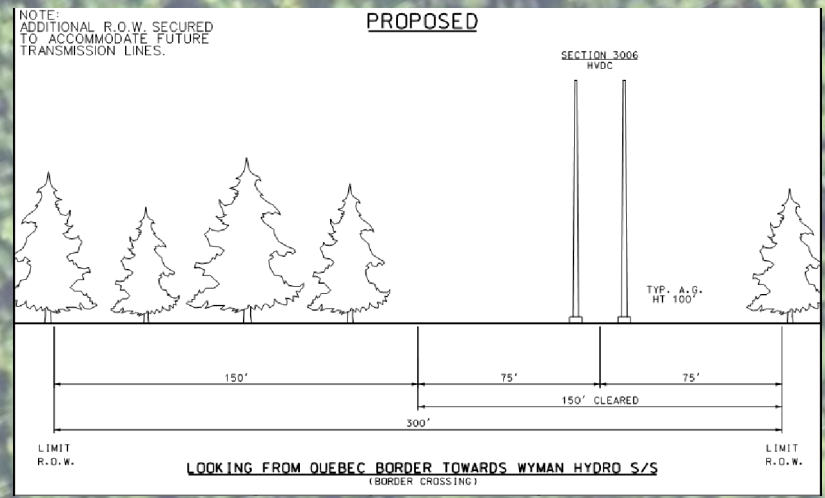
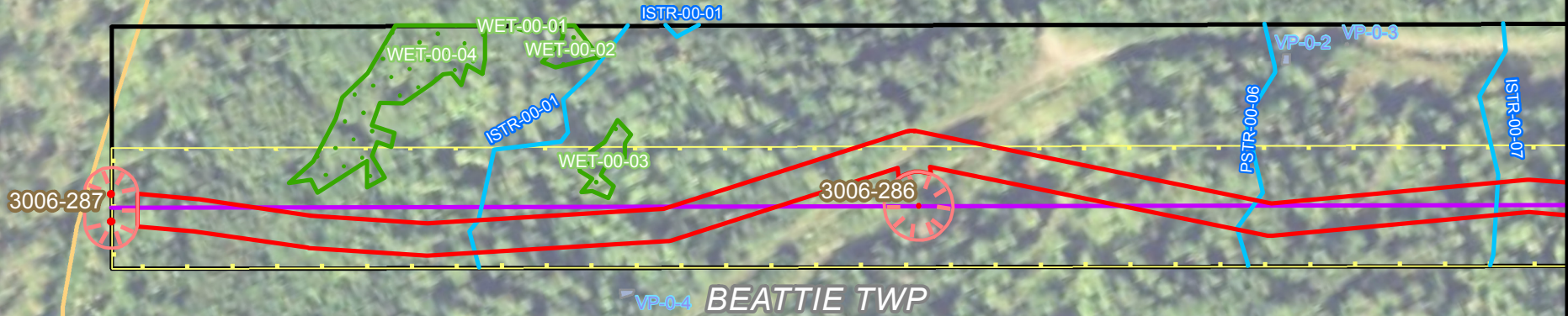

Legend

- CMP Ownership / Easement Extent
- Project Centerline
- Pole Footprint
- Access Road
- Work Pad
- Clearing Limits
- Wetland
- Stream
- NVP
- Town Boundary

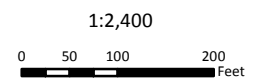

Note: cross section not to scale

**New England
Clean Energy Connect
Border Crossing Plan**



Attachment E: USACE New England District Construction Mat BMPs



Construction Mat Best Management Practices (BMPs)

Installation	
	<ul style="list-style-type: none">• Mats should be in good condition to ensure proper installation, use and removal.• Operating heavy equipment in wetlands shall be minimized, and such equipment other than fixed equipment (drill rigs, fixed cranes, etc.) shall not be stored, maintained, fueled or repaired in wetlands unless the equipment is broken down and cannot be easily removed.• An adequate supply of spill containment equipment shall be maintained on site.• General Permits in New England do not authorize dragging construction mats into position in waters of the U.S.• Woody vegetation (trees, shrubs, etc.) shall be cut at or above ground level and not uprooted in order to prevent disruption to the wetland soil structure and to allow stump sprouts to revegetate the work area.• Where feasible, place mats in a location that would minimize the amount needed for the wetlands crossing.• Minimize impacts to wetland areas during installation, use, and removal.• Install adequate erosion and sediment controls at approaches to mats to promote a smooth transition to, and minimize sediment tracking onto, swamp mats.• In most cases, construction mats should be placed along the travel area so that the individual boards are resting perpendicular to the direction of traffic. No gaps should exist between mats. Place mats far enough on either side of the resource area to rest on firm ground.• Provide standard construction mat BMP details to work crews (examples provided below).
Wetland/Stream Channel Crossing	
	<ul style="list-style-type: none">• At “dry” crossings where no flow is present or anticipated during project construction, the mats may be placed directly onto the ground in order to prevent excessive rutting, provided stream banks and bottoms are not adversely altered.• Construction mats may be used as a temporary bridge over a stream to allow vehicles access to the work site. Small sections of mat are placed within and along the stream parallel to the flow of water. Mats may then be placed perpendicular to the stream, resting on top of the initial construction mat supports. It may be necessary to place additional reinforcement for extra stability and to minimize the amount of sediment that could fall between the spaces of each timber.• In areas where wildlife passage or migration is a consideration, mats may be installed in accordance with the diagram “Typical Stream Crossing with Swamp Mats.”• Mats should not be placed so that they restrict the natural flow of the stream.• Minimize number of stream/wetland crossings. Where feasible, locate crossing site where stream channel is narrow for the shortest possible clear span and where stream banks are stable and well defined. For large wetland complexes, consider accessing structures from opposite sides where possible to avoid crossing the entire wetland.• More than one layer of mats may be necessary in areas which are inundated or have deep organic wetland soils.

Maintenance	
	<ul style="list-style-type: none"> Matted wetland crossings should be monitored to assure correct functioning of the mats. Inspect mats after use. Look for any defects or structural problems. Mats which become covered with soils or construction debris should be cleaned and the materials removed and disposed of in an upland location. The material should not be scraped and shoveled into the resource area. Mats which become imbedded must be reset or layered to prevent mud from covering them or water passing over them.
Removal	
	<ul style="list-style-type: none"> Matting should be removed by “backing” out of the site, removing mats one at a time. Any rutting or significant indentations identified during mat removal should be regraded immediately, taking care not to compact soils. Mats should be cleaned before transport to another wetland location to remove soil and any invasive plant species seed stock or plant material. Mats shall be cleaned of soil and any invasive plant species seed stock or plant material from before installation. Cleaning methods may include but are not limited to shaking or dropping mats in a controlled manner with a piece of machinery to knock off attached soil and debris, spraying with water or air, and sweeping. Crossings should be inspected following mat removal to determine the level of restoration required.
Restoration	
	<ul style="list-style-type: none"> Special precautions should be taken to promptly stabilize areas of disturbed soil located near wetlands and streams. Matted areas within wetlands shall be restored to their original condition and elevation. This may involve natural revegetation from existing root and seed stock of native plant species. Conditions may warrant planting and the broadcast of a wetland seed mix over the matted area to supplement the existing seed and rootstock. Seed mixes and vegetation shall contain only plant species native to New England. The use of mulch in wetlands shall consist of weed-free mulch to mitigate the risk of the spread of invasive plant species.

Example Mat Diagrams -

Best Management Practices Manual for Utility Maintenance
 In and Adjacent to Wetlands and Waterbodies in New Hampshire
 Interim January 2010.

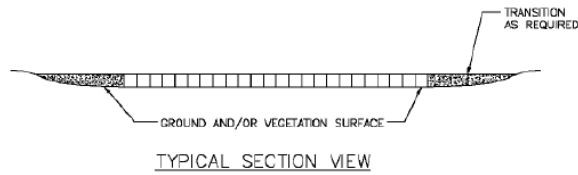
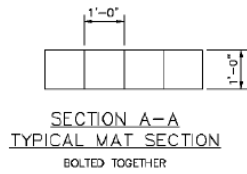
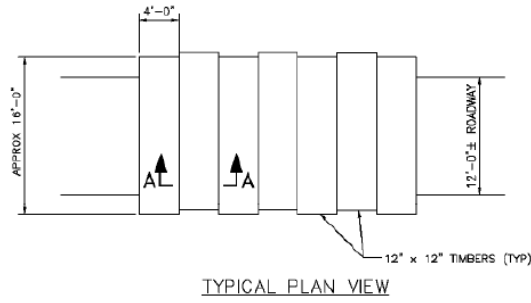

- NOTE:
1. TO BE INSTALLED IF NECESSARY TO PREVENT RUTTING, TO ACCESS STRUCTURES.
 2. THIS DETAIL SHOWS TYPICAL DIMENSIONS. SOME CONTRACTORS SWAMP MATS ARE DIMENSIONALLY DIFFERENT FROM WHAT IS SHOWN HERE.
 3. DEPENDENT ON SITE CONDITIONS, MULTIPLE LAYERS OF SWAMP MATS MAY BE INSTALLED.

Best Management Practices Manual for Utility Maintenance
 In and Adjacent to Wetlands and Waterbodies in New Hampshire
 Interim January 2010.

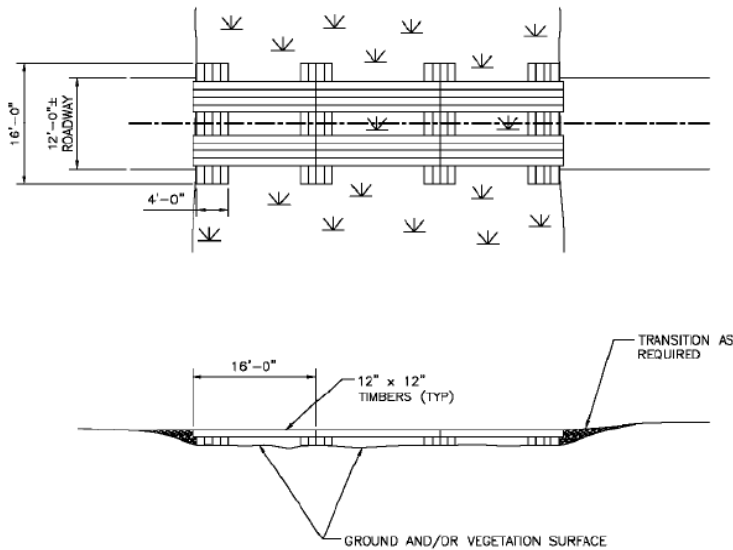

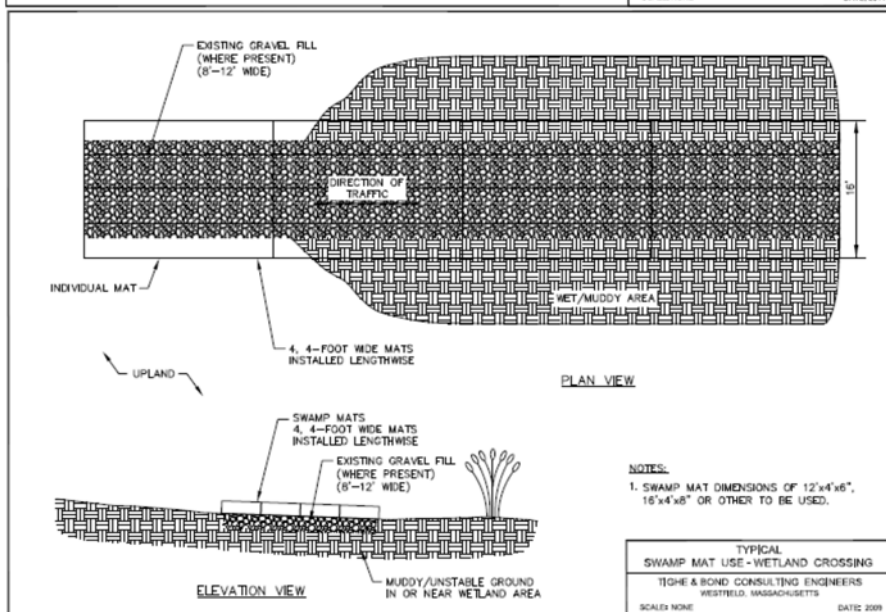
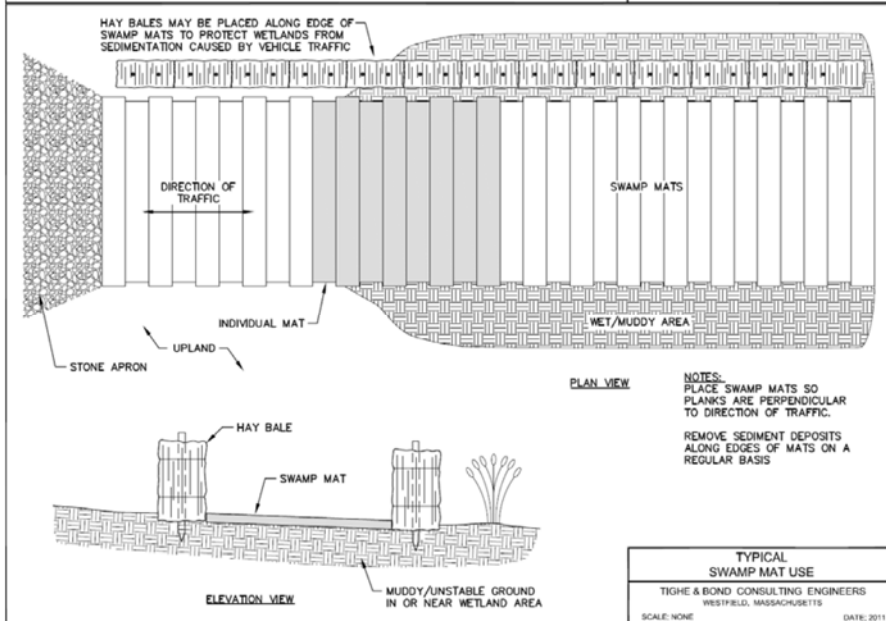
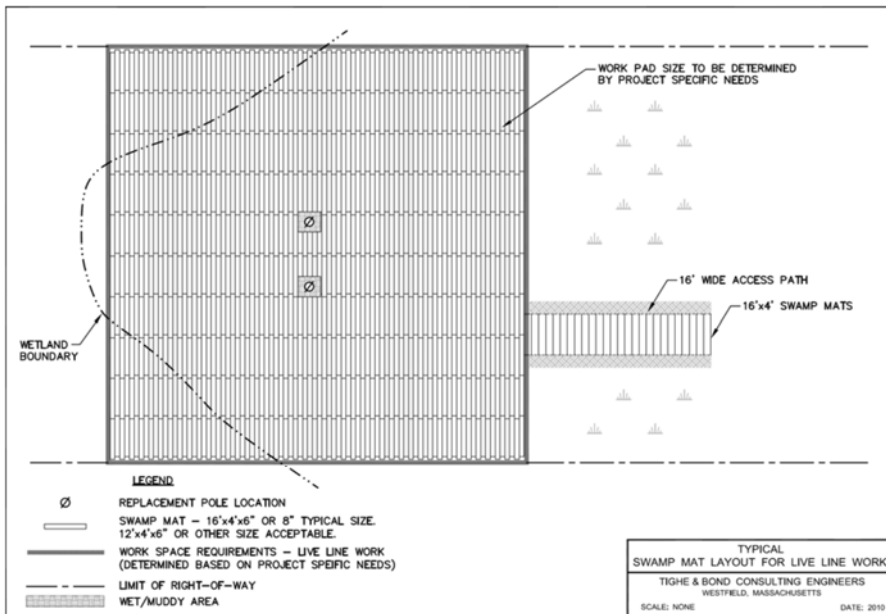

Attachment IX

November 20, 2017

CENTRAL MAINE POWER

±320 kV HVDC UG Transmission Line and Termination Stations Kennebec River Crossing *HVDC Underground Transmission Line Crossing Report*

PROJECT NUMBER:
147483

PROJECT CONTACT:

Jesse Sawin
Les Hinzman
Mark Reynolds

EMAIL:

jesse.sawin@powereng.com
les.hinzman@powereng.com
mark.reynolds@powereng.com

PHONE:

(207) 869-1443
(208) 788-0577
(503) 892-6733



HVDC Underground Transmission Line Crossing Report

PREPARED FOR: CENTRAL MAINE POWER

PREPARED BY:

JESSE SAWIN

(207) 869-1443

JESSE.SAWIN@POWERENG.COM

LES HINZMAN

(208) 788-0577

LES.HINZMAN@POWERENG.COM

MARK REYNOLDS

(503) 892-6733

MARK.REYNOLDS@POWERENG.COM

REVISION HISTORY		
DATE	REVISED BY	REVISION
10/20/17	Les Hinzman	A – Issued for Review
11/01/17	Les Hinzman	B – Draft Report
11/17/17	Les Hinzman	0 – Final Report
11/20/17	Les Hinzman	1 – Final Report

TABLE OF CONTENTS

INTRODUCTION..... 1

 TERMINATION STATION(S) SUMMARY DESCRIPTION 3

 CABLE AMPACITY 5

 RELIABILITY ASSESSMENT 5

 ESTIMATED COSTS ±320 kV HVDC OVERHEAD AND UNDERGROUND TRANSMISSION LINES 5

APPENDICES

- ESTIMATE BACKUP
- UG CABLE AMPACITY
- STATION LAYOUT AND ROUTE MAPS
- RELIABILITY ANALYSIS
- DESIGN CRITERIA

INTRODUCTION

The Central Maine Power (CMP) High Voltage Direct Current (HVDC) Transmission Line for the New England Clean Energy Connect (NECEC) Project is a ± 320 kV HVDC overhead, single circuit or symmetrical monopole (2-line poles) transmission line capable of transferring 1,200 MW. The project is about 207 miles overall with approximately 145 miles within the US. The line extends through Western Maine from the Appalaches Substation in Thetford Mines, Quebec, Canada and terminates near Lewiston, Maine in the United States. CMP is considering a ± 320 -kV HVDC underground transmission line for the crossing of the Kennebec River.

The ± 320 -kV HVDC underground transmission line segment would be installed in lieu of an overhead river crossing span. The project would require two overhead-to-underground Cable Termination (Transition) Stations located near the Kennebec River. In order to achieve the 1,200 Megawatt (MW) rating, each pole will require a 2500 mm² (nearly equivalent to 5,000 kcmil) copper conductor, cross-linked polyethylene (XLPE) insulated underground cable. A spare cable would be installed that could be connected to either pole after only a brief outage should a cable or termination failure occur.

A Horizontal Directional Drill (HDD), approximately 2,900 feet in length and 360 feet in depth, would be utilized for the Kennebec River crossing to install a duct bank consisting of, at a minimum: three (3) ten-inch (10") ducts, one (1) four-inch (4") duct, and two (2) two-inch (2") ducts (all HDPE).



NECEC ± 320 -kV HVDC Underground Transmission Line - Kennebec River Crossing

It is anticipated that the HDD could be accomplished with a thirty-six inch (36") bore annulus within the proposed overhead transmission line corridor, which is 300 feet in width. The bore would pass beneath the Kennebec River with approximately thirty-feet (30') of clearance from the river bottom.

The HVDC underground cable installation would require approximately fifteen-hundred feet (1500') of open trenching to connect to the Cable Termination Stations.

Pull-through vaults will be located within each station. These vaults would be utilized for splicing should a termination failure occur allowing for the replacement of a short length of cable for the termination restoration.



Proposed Access Roads

Upgrades on approximately fifteen miles of unimproved roads and the associated bridges would be required to provide access to the Termination Substations in addition to the grading necessary for the stations and the laydown area for the drilling equipment. The costs for the access roads are included in both the Overhead Line estimate and the Termination Substation estimate, but not in the underground estimate.



Eastern Access: One-Lane Bridge near East Moxie

Eastern Access: Utilize US Highway 201, Lake Moxie Road, and Indian Pond Road to Black Brook Pond Road. Continue on Brook Pond Road to Fish Road and Fish Pond Road where the access will then extend over local logging roads, although some tree clearing and new roadway may be necessary. Also, bridge weight limits along this route would be questionable and could require upgrades, which were not considered in these estimated costs.

Western Access: From US Highway 201 use Capital Road and Wilson Hill Road to the area near the transition station where the access may require some tree clearing and new roadway.

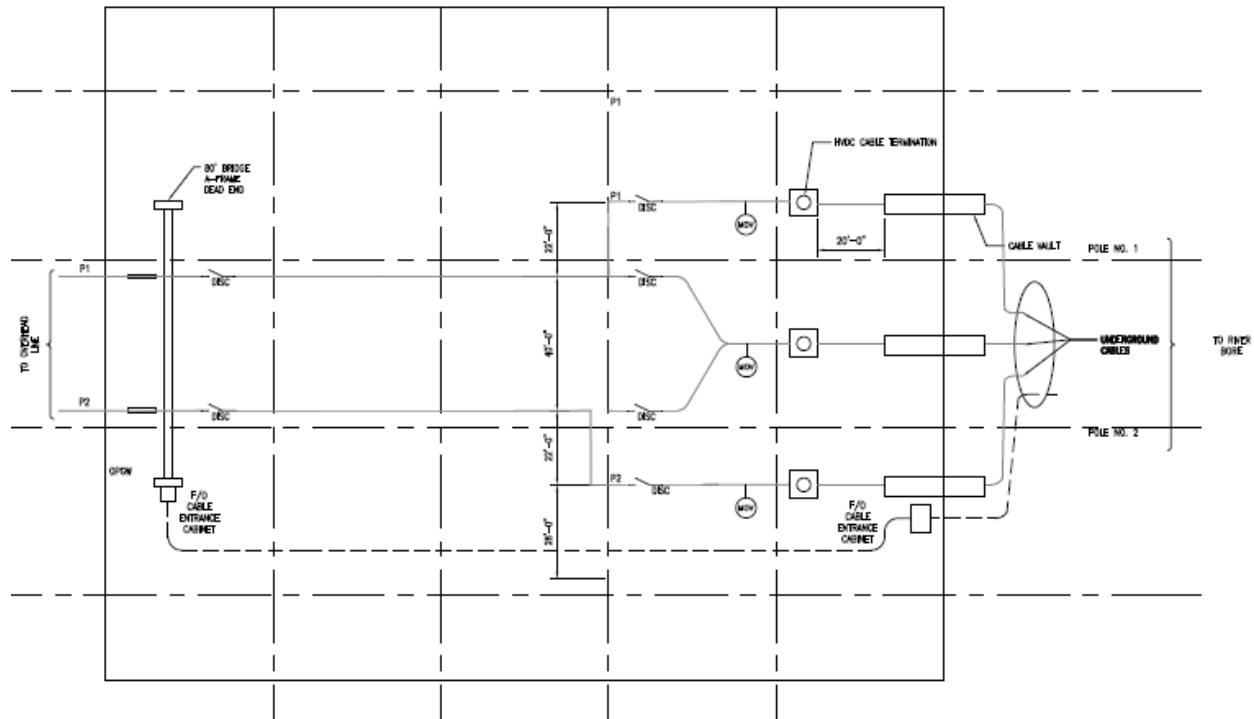

Termination Station Layout

Termination Station(s) Summary Description

The project will include two Kennebec River Termination Stations to transition the underground cable section of ±320 kV HVDC transmission system. There would be three underground XLPE Type (Oil Free) Cables installed as well as a section fiber optic cable to transition from overhead optical ground wire (OPGW) to underground type or loose-tube cable. The station development is essentially the same on both sides of the river, with an approximate 200 foot by 250 foot station footprint.

Except for the Overhead Line (OH) deadend the development the overall station would be a low profile arrangement, which will not be visible from the river in the current proposed locations. The termination stations would require some light vehicular access after construction is complete, and would normally have only infrequent operations staff visits to check security and equipment serviceability. There would not be any permanent power (station service) development or building developments at the stations.

The stations will have manually operated disconnect switches to provide for the substitution of the spare cable that would be installed with the two pole cables and the fiber optic underground section. The spare cable would be utilized during the unlikely event of a cable fault in either pole cables and would be identical to the pole cables. Since this reconfiguration has a very low probability event, this is the only time after initial construction where multiple vehicles and CMP personnel would be in the station for the period of 1 to 2 days, performing tests and relocating the removable bus sections.

Since these stations are essentially passive there would be no active security features built into the apparatus or switches. A set of passive cable fault indicators is planned to provide an indication of a cable fault situation that will normally be sensed by the HVDC Terminal Stations. Since modern external fault location technology is good to approximately ± 500 Meters, a set of passive cable fault locators would be installed on each end of the cables.

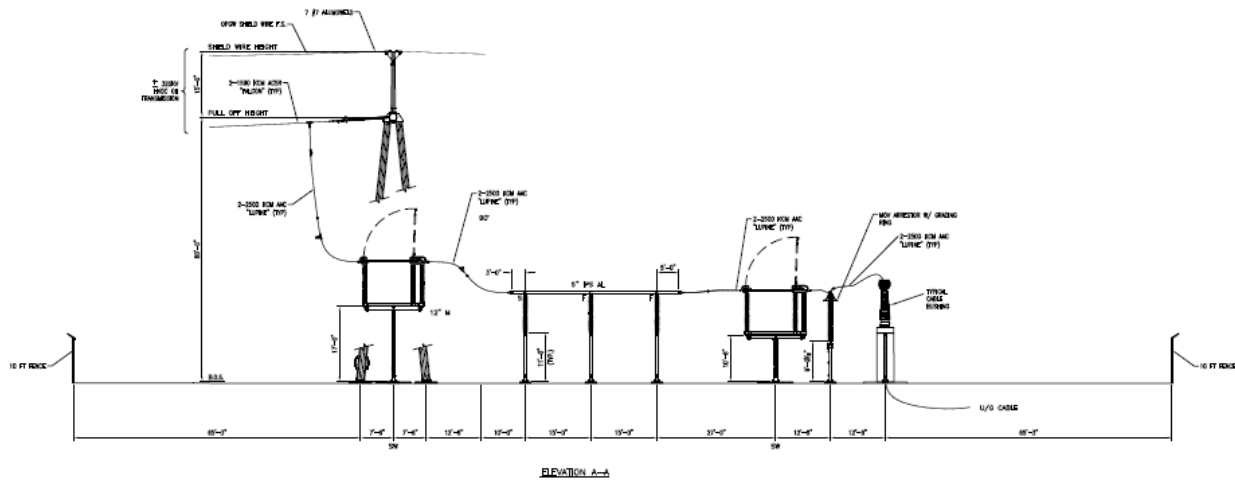

Each Cable Termination Station essentially consists of a main deadend to terminate the overhead line section and allow for the transition of OPGW to the Fiber Optic underground cable. This is also an opportunity, if needed, to drop off some of the fibers for a local distribution connection, which is beyond the current project scope.

Inside the station fence will be a set of manual operated disconnect switches to allow for OH and Underground section testing and maintenance activities as well as provide visible means of protecting crews from inadvertent energization of facilities. There would be metal oxide varistors (MOV) surge arrestors at both stations to protect the underground cable from lightning induced high voltage surges. None of the equipment within the station will produce any audible noise, other than the usual low level corona noise levels associated with the transmission line itself.

There would be standard substation fencing around the facility approximately 10 feet tall with barbed wire top. All switches, gates and other equipment would be locked with CMP standard locksets. There will be no active station lighting and if lighting is required for maintenance activities, temporary portable generator supplied lighting would be utilized. Access roadways to the stations would be gated and padlocked as an additional security measure.

Cable Ampacity

A study was performed to identify a preliminary cable conductor size to meet the requirements for normal loadings of the ±320-kV HVDC underground transmission line crossing of the Kennebec River.

Calculations were performed using CYME International’s Cable Ampacity Program (CYMCAP) version 7.2 Rev. 3 in accordance with IEC 60287 “Electric Cables – Calculation of the Current Rating”. The assumptions for this calculation are based on the design criteria for the project utilizing engineering design experience:

Nominal Voltage:..... ±320 kV HVDC
 Conductor: 2500 mm² Circular Copper
 Cable System: Cross Length Polyethylene (XLPE)
 Maximum Conductor Operating Temperature: 70°C (steady-state)
 Assumed Native Soil Thermal Resistivity: 80°C-cm/W
 Assumed Thermal Backfill Thermal Resistivity: 60°C-cm/W
 Assumed Drilling Fluid Thermal Resistivity: 140°C-cm/W
 Daily (24-Hour) Load Cycle Factor: 100%
 Assumed Earth Ambient Temperature: 6°C (42°F)
 Cable Conduit: 10-inch HDPE SDR 9
 Target Ampacity: 1,875 Amps (1,200 MVA)

Maximum cable ampacity was calculated for the following case:
 Horizontal directional drill 36-inch bore crossing thirty feet (30’) beneath the Kennebec River bottom rated for 1,877 Amps. This can be accomplished with a 2,500 mm² copper conductor XLPE cable. It should be noted that this cable would limit the overload capability of the HVDC equipment.

Reliability Assessment

Availability ratings for a ±320 kV HVDC overhead and underground transmission lines are similar, however, it should be noted that HVDC cable faults are usually if not always non-restorable without removal and replacement of at least one of the pole conductors, which is why the installed spare cable is being considered.

Estimated Costs ±320 kV HVDC Overhead and Underground Transmission Lines

The purpose of these estimates is to create a budgetary comparison of the overhead vs. underground alternatives. Several costs would be the same for both alternatives such as: real estate, owner internal costs, program management, AFUDC, etc. and are not included to simplify the comparison of the two alternatives.

DESCRIPTION	COSTS (2017)	COSTS (2021)
UG T-Line	\$19,602,100	\$21,217,943
Transition Station (East)	\$ 7,226,000	\$ 7,821,655
Transition Station (West)	\$ 7,486,000	\$ 8,103,087
Total	\$34,314,100	\$37,142,685

DESCRIPTION	COSTS (2017)	COSTS (2021)
Overhead T-Line Crossing (3 Structures)	\$ 5,613,717	\$ 6,076,287

CONFIDENTIAL

IECG-001-033
Attachment 1, Page 9 of 70
Docket No. 2017-232

APPENDICES

CONFIDENTIAL

Kennebec Gorge Crossing OH Costs - Option 1			
Overhead Line Summary	Material Costs	Labor Costs	Total Cost
(2) Self-Supporting DE Structures	\$250,221	\$910,180	\$1,160,401
(1) Tangent Structures	\$40,643	\$0	\$40,643
Conductor, OPGW, & OHGW	\$37,821	\$56,010	\$93,831
Insulators	\$34,580	\$0	\$34,580
Hardware	\$903	\$0	\$903
Access, Inspection, Environmental Controls, Clearing, & Mob/Demob	\$0	\$3,026,600	\$3,026,600
Survey	\$0	\$100,000	\$100,000
Permitting, Engineering, & Procurement	\$0	\$201,110	\$201,110
Sales Tax	\$20,029.26	\$0	\$20,029.26
Subtotal			\$4,678,097
20% Contingency			\$935,619
Total (2017)			\$5,613,717
Total (2021)			\$6,076,287

General Assumptions

- Crossing Length – 2,560'
- Tangent Structures – Direct Embed Steel Poles
- Dead End Structures – Self Supporting Steel Poles on Drilled Shaft Foundations
- 1590 kcmil 54/19 ACSR “Falcon” Conductor – Twin Bundled Poles
- OPGW – 0.913” Diameter
- OHGW – 7 No.7 Alumoweld
- 1 Tangent
- 2 Dead Ends

CONFIDENTIAL**Preliminary**

**Iberdrola - CMP
Kennebec River Crossing: +/- 320kV, 1200 MVA HVDC
Summary of Costs**

UNDERGROUND LINE SUMMARY	XLPE Cable System Costs		Total Cost
	Material Costs	Labor Costs	
Duct Bank	\$292,400	\$496,200	\$788,600
Trenchless Installations	\$4,785,000	\$4,785,000	\$9,570,000
Manholes	\$360,000	\$300,000	\$660,000
Cable	\$1,825,000	\$187,500	\$2,012,500
Splices	\$33,000	\$0	\$33,000
Arresters	\$17,600	\$15,000	\$32,600
Additional Cable Accessories	\$61,100	\$55,500	\$116,600
Communication System	\$16,800	\$23,800	\$40,600
Temperature Monitoring System	\$113,200	\$51,800	\$165,000
Transition Structures, ea	\$138,000	\$72,000	\$210,000
Mob/Demob	\$0	\$450,000	\$450,000
Survey	\$0	\$100,000	\$100,000
Partial Discharge Testing	\$0	\$200,000	\$200,000
Engineering and Construction Management	\$0	\$1,200,000	\$1,200,000
Sales Tax (5.5%)	\$434,100	\$0	\$434,100
SUBTOTAL	\$7,892,100	\$8,008,800	\$16,335,000
20% Contingency	\$1,665,300	\$1,601,800	\$3,267,100
TOTAL (2017)	\$9,557,400	\$9,410,600	\$19,602,100
TOTAL (2021)			\$21,217,943

Underground Transmission Line Notes:

1. +/-320kV, 1200 MVA, HVDC, 1 cable per pole, 1 installed spare cable 2500 mm² Cu, XLPE insulation
2. One (1) 2900 ft length, 36 inch dia HDD bores without casings
3. 1500 ft total open trench lengths adding both sides
4. Fluidized thermal backfill for 100% of the open trench portion of the route
5. Six (6) arresters with two (2) spares included
6. Six (6) Terminations with two (2) spares included
7. One (1) communication circuit, 48 count loose tube fiber optic cable, with testing
8. Temperature monitoring equipment included for remote operation
9. Costs associated with excavation of rock included
10. No reel of spare cable included
11. No reactive compensation included
12. State sales tax included at 5.5%
13. Transition structures, foundations, and access roads included in Transition Station estimate
14. Materials used in this cost estimate meet all applicable industry standards
15. Costs for: access roads, vegetation and tree clearing included in Transition Station estimate
16. Dewatering assumed unnessessary
17. Escalation calculated at 2% per year

CMP 1-Cable Per Pole



Kennebec River Crossing (Eastern Terminal) HVDC

PLANNING ESTIMATE

DESCRIPTION	LABOR	MATERIAL	L & M
ESTIMATED COST SUMMARY			
EQUIPMENT (outdoor)	264,000	567,000	831,000
STRUCTURES	321,000	698,000	1,019,000
FOUNDATIONS	278,000	108,000	386,000
CABLE & CONDUIT	88,000	55,000	143,000
CONTROL ENCLOSURE	-	-	-
SITE IMPROVEMENTS	2,302,000	547,000	2,849,000
REMOVALS	-	-	-
TESTING & ENERGIZATION	95,000	-	95,000
SUBTOTAL	3,348,000	1,975,000	5,323,000
CONTRACTOR MOB/DEMOB			-
CONSTRUCTION MANAGEMENT			216,000
ENGINEERING			373,000
ENVIRONMENTAL			
REAL ESTATE COSTS			
UTILITY INTERNAL COSTS (0%)			-
SALES TAX (5.5%)			109,000
SUBTOTAL			6,021,000
CONTINGENCY (20%)			1,205,000
TOTAL ESTIMATED COST			7,226,000
TOTAL ESCALATED COST	2021	2% per year	7,821,655

1 Cable Per Pole



Kennebec River Crossing (Western Terminal) HVDC

PLANNING ESTIMATE

DESCRIPTION	LABOR	MATERIAL	L & M
ESTIMATED COST SUMMARY			
EQUIPMENT (outdoor)	313,000	633,000	946,000
STRUCTURES	291,000	646,000	937,000
FOUNDATIONS	390,000	151,000	541,000
CABLE & CONDUIT	88,000	55,000	143,000
CONTROL ENCLOSURE	-	-	-
SITE IMPROVEMENTS	2,302,000	547,000	2,849,000
REMOVALS	-	-	-
TESTING & ENERGIZATION	95,000	-	95,000
SUBTOTAL	3,479,000	2,032,000	5,511,000
CONTRACTOR MOB/DEMOB			-
CONSTRUCTION MANAGEMENT			229,000
ENGINEERING			386,000
ENVIRONMENTAL			
REAL ESTATE COSTS			
UTILITY INTERNAL COSTS (0%)			-
SALES TAX (5.5%)			112,000
SUBTOTAL			6,238,000
CONTINGENCY (20%)			1,248,000
TOTAL ESTIMATED COST	2017		7,486,000
TOTAL ESCALATED COST	2021	2% per year	8,103,087

Client: Central Maine Power
Project Name: Kennebec River Crossing
Project Number: 147483

Prepared By: Ethan Evans
Date: 15-Nov-17
Checked By: Les Hinzman
Date: 15-Nov-17

HDD Bore Design - Ampacity Calculation Summary

Case	Case Description	Steady State Ampacity Requirement (A)	Max Operating Temperature of Conductor (°C)	Results					Installation Assumptions				
				Max Continuous Ampacity (A)	Load Factor (%)	Earth Ambient Temperature (°F)	Bentonite Drilling Fluid Thermal Resistivity (°C-cm/W)	Native Soil Thermal Resistivity (°C-cm/W)					
1	36 inch HDD Bore, 30 ft from top of Borehole to Bottom of Kennebec River							42	140	80			
	± 320 kV HVDC	1875	70	1881	100								

Calculations modeled using CYMCAP 7.2 Rev. 3

Cable

- Conductor size: 2500 mm² circular Cu
- Insulation thickness: 846 mils
- Shield type: Aluminum laminate

Assumptions

- 36 inch HDD bore without casing, with 10" SDR 9 HDPE Conduit
- Steady state ampacity requirement DC line - 1875A (1200 MVA)
- No bonding in DC installations
- Drilling fluid (bentonite) backfill used in bore
- Skin, Proximity Effects, and Dielectric Losses not a factor in DC installations

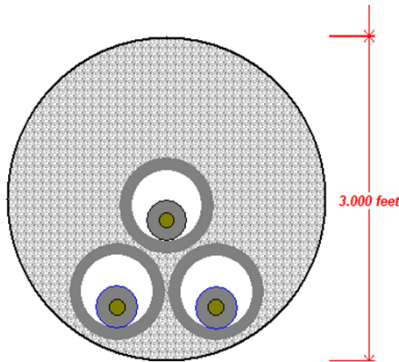

HDD BORE DETAIL

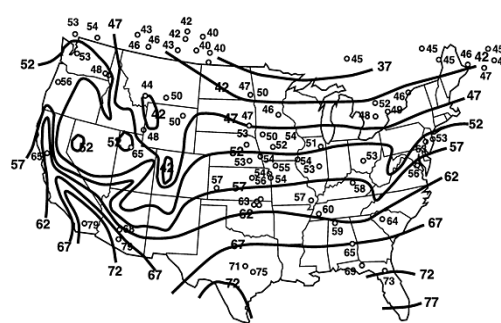

Mean annual earth temperature observations at individual stations, superimposed on well-water temperature contours.

MEAN ANNUAL TEMPERATURE

CABLE DRAWING 2500 mm² Cu XLPE 320kV (HVDC)



1 – CONDUCTOR	Segmented or circular Cross-section: 2500 mm ² Material: Copper Indicative diameter: 62.3 mm (2.45 inch)
2 - INNER SEMI-CONDUCTIVE LAYER	Indicative thickness: 1.5 mm (59 mils)
3 - INSULATION	Material: cross-linked polyethylene Minimum average thickness*: 21.5 mm (846 mils)
4 - OUTER SEMI-CONDUCTIVE LAYER	Indicative thickness: 1.5 mm (59 mils)
5 - SWELLING TAPES	
6 - ALUMINUM LAMINATE	Indicative thickness: 0.5 mm (20 mils)
7 - OUTER SHEATH AND EXTRUDED SEMICONDUCTING LAYER	Material: HDPE Minimum average thickness*: 4 mm (157 mils)
	INDICATIVE EXTERNAL DIAMETER (D): 125 MM (4.9 IN)
	INDICATIVE WEIGHT: 31.6 KG/M (21.2 LBS/FT)
	MINIMUM BENDING RADIUS** - during pulling: 35 D in ducts, 30 D on rollers. - in permanent: 20 D
	MAXIMUM PULLING TENSION**: 22500 lbs (10000 daN)
	MAXIMUM SIDEWALL PRESSURE: 2000 lbs/ft (3000 daN/m)

* The measured thickness at any point may be smaller within the tolerances defined in the IEC 62067

** Real values to be applied during installation will be validated by General Cable based on real installation data, pulling tension, sidewall pressure, once the site survey will be performed on the final cable route. Installation conditions when cables are pulled on rollers shall avoid any excessive side wall pressures and guarantee safe working conditions.

ELECTRICAL CHARACTERISTICS

Nominal DC resistance at 20°C:	0.072 Ω/km (0.0219 Ω/1000ft)
Nominal DC resistance at 70°C	0.087 Ω/km (0.0265 Ω/1000ft)
Nominal capacitance:	0.256 μF/km (0.078 μF/1000ft)
Maximum conductor temperature	70°C

CONFIDENTIAL

Study Summary

CYMCAP Version	7.2 Revision 01
Study:	320 kV DC and 1200 MW Cable Sizing Calculations Max LF
Execution:	2500mm2 320 kV DC 1 cb_ph W_Spare 15 deg Tr MaxLF
Date:	11/15/2017 1:13:18 PM

General Simulation Data

Steady State Option	Unequally Loaded
Consider Electrical interaction between circuits	No
Induced currents in metallic layers as a fraction of conductor current (applied to all single phase circuits) :	0.0
Conductor Resistances Computation Option:	IEC-228

Installation Type: Multiple Ductbanks/Backfills

Ambient Soil Temperature at Installation Depth	[°C]	6.0
Native Soil Thermal Resistivity	[K.m/W]	0.8
Consider Non-Isothermal Earth Surface		No

Layer Name	X [ft]	Y [ft]	Width [ft]	Height [ft]	Thermal Resistivity [K.m/W]
NSTD DB1	0.0	34.5	2.729	2.729	1.4

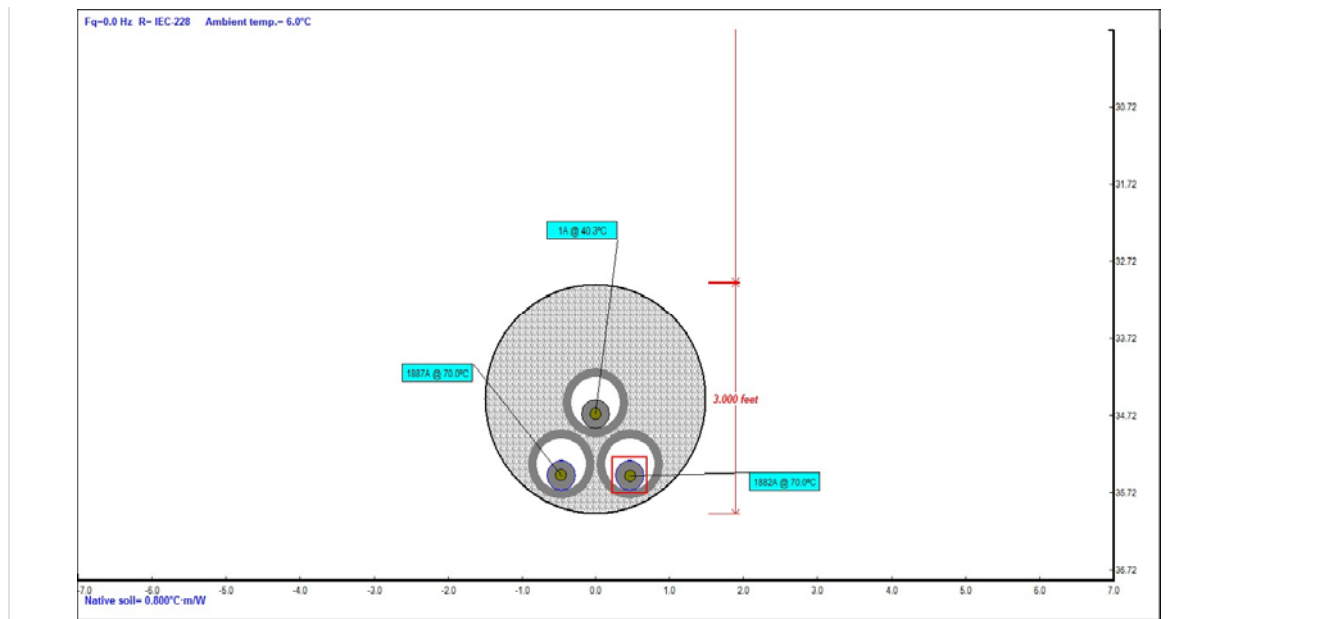

Results Summary

Cable No.	Cable ID	Circuit No.	Feeder ID	Cable Phase	Cable Frequency	Daily Load Factor	X coordinate [ft]	Y coordinate [ft]	Conductor temperature [°C]	Ampacity [A]
1	GEN CABLE 2500MM HVDC	1		A	0.0	1.0	0.47	35.5	70.0	1881.6
2	GEN CABLE 2500MM HVDC	2		A	0.0	1.0	-0.47	35.5	70.0	1887.3
3	GEN CABLE 2500MM HVDC	3		A	0.0	1.0	0.0	34.7	40.3	1.0

CONFIDENTIAL

	Cables Report
CYMCAP Version	7.2 Revision 01
Study:	320 kV DC and 1200 MW Cable Sizing Calculations Max LF
Execution:	2500mm ² 320 kV DC 1 cbl_ph W_Spare 15 deg Tr MaxLF
Date:	11/15/2017 1:13:18 PM

No.	Description	Unit	1
General Cable Information			
1	Cable Equipment ID		GEN CABLE 2500MM HVDC
2	Number of Cores		Single Core
3	Voltage	[kV]	640
4	Conductor Area	[in ²]	3.88
5	Cable Overall Diameter	[in]	4.73
6	Maximum Steady-State Conductor Temperature	[°C]	70
7	Maximum Emergency Conductor Temperature	[°C]	110
Conductor			
8	Material		Copper
9	Electrical Resistivity at 20°C	[μΩ.cm]	1.7241
10	Temperature Coefficient at 20°C	[1/K]	0.00393
11	Reciprocal of Temperature Coefficient of Resistance (BETA)	[K]	234.5
12	Volumetric Specific Heat (SH)	[J/(K*cm ³)]	3.45
13	Construction		Round Stranded
14	Number of Wires Composing Stranded Conductor		n/a
15	Conductor Insulation System		Extruded
16	Milliken Wires Construction		n/a
17	Ks (Skin Effect Coefficient)		1
18	Kp (Proximity Effect Coefficient)		1
19	Diameter	[in]	2.45
Conductor Shield			
20	Thickness	[in]	0.06
21	Diameter	[in]	2.57
Insulation			
22	Material		XLPE Unfilled
23	Thermal Resistivity	[K.m/W]	3.5
24	Dielectric Loss Factor - (tan delta)		0.001
25	Relative Permittivity - (epsilon)		2.5
26	Specific Insulation Resistance Constant at 60°F - (K)	[MΩ.1000ft]	20000.
27	Thickness	[in]	0.85
28	Diameter	[in]	4.26
Insulation Screen			
29	Material		Semi Conducting Screen
30	Thickness	[in]	0.06
31	Diameter	[in]	4.38

CONFIDENTIAL

Sheath			
32	Is Sheath Around Each Core?		n/a
33	Material		Aluminum
34	Electrical Resistivity at 20°C	[μΩ.cm]	2.8264
35	Temperature Coefficient at 20°C	[1/K]	0.00403
36	Reciprocal of Temperature Coefficient of Resistance (BETA)	[K]	228
37	Volumetric Specific Heat (SH)	[J/(K*cm ³)]	2.5
38	Corrugation Type		Non Corrugated
39	Thickness	[in]	0.02
40	Diameter	[in]	4.42
Jacket			
41	Material		Polyethylene
42	Thermal Resistivity	[K.m/W]	3.5
43	Thickness	[in]	0.16
44	Diameter	[in]	4.73

No.	Description	Unit	1
Specific Installation Data			
45	Cable Equipment ID		GEN CABLE 2500MM HVDC
46	Cable Frequency	[Hz]	0.0001
47	Sheath / Shield Bonding		1 Conductor No Bonding
48	Loss Factor Constant (ALOS)		0.3
49	Duct construction		Polyethylene in Concrete
50	Duct material thermal resistivity	[K.m/W]	3.5
51	Inside Diameter of the Duct/Pipe	[in]	8.22
52	Outside Diameter of the Duct/Pipe	[in]	10.75

CONFIDENTIAL**Cable ID : GEN CABLE 2500MM HVDC**

Cable Title General Cable 2500 mm2 Cu XLPE 320kV HVDC

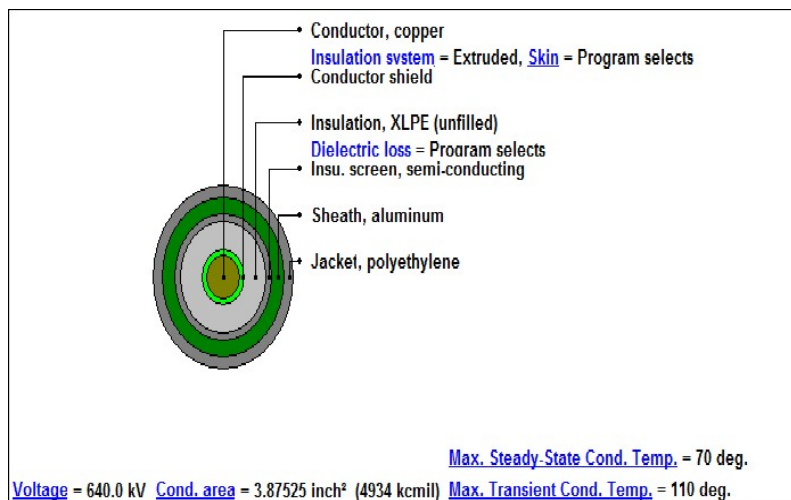
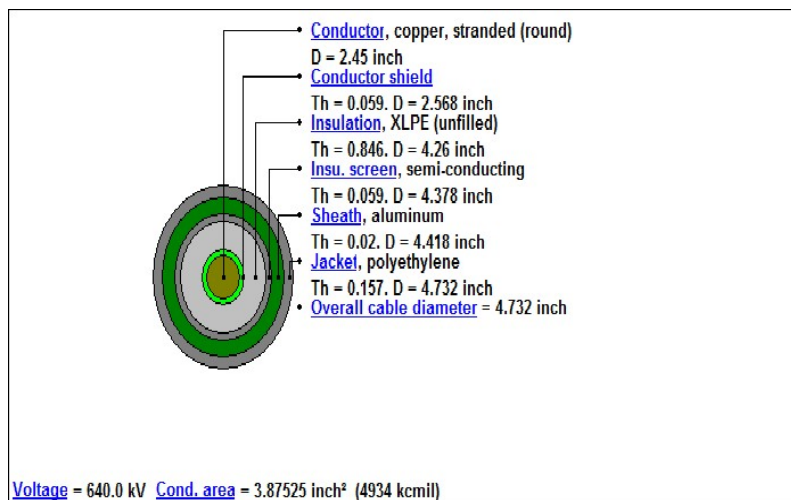

CONFIDENTIAL

EYME INTERNATIONAL T&D		Electrical Parameters
CYMCAP Version	7.2 Revision 01	
Study:	320 kV DC and 1200 MW Cable Sizing Calculations Max LF	
Execution:	2500mm ² 320 kV DC 1 cbl_ph W_Spare 15 deg Tr MaxLF	
Date:	11/15/2017 1:13:18 PM	

No.	Description	Unit	Cable No.1	Cable No.2	Cable No.3
1	Cable Equipment ID		GEN CABLE 2500MM HVDC	GEN CABLE 2500MM HVDC	GEN CABLE 2500MM HVDC
Resistances					
2	DC Resistance of the conductor at 20°C	[Ω/mile]	0.01132	0.01132	0.01132
3	DC Resistance of Conductor at Operating Temperature	[Ω/mile]	0.01354	0.01354	0.01222
4	AC Resistance of Conductor at 20°C	[Ω/mile]	0.01132	0.01132	0.01132
5	AC Resistance of Conductor at Operating Temperature	[Ω/mile]	0.01354	0.01354	0.01222
6	DC Resistance of Sheath at 20°C	[Ω/mile]	0.25514	0.25514	0.25514
7	DC Resistance of Sheath at Operating Temperature	[Ω/mile]	0.29665	0.29659	0.276
Losses					
8	Conductor Losses	[W/ft]	9.08223	9.13685	0.0
9	Dielectric Losses	[W/ft]	0.00001	0.00001	0.00001
10	Metallic Screen Losses	[W/ft]	0.0	0.0	0.0
11	Aarmor/Pipe Losses	[W/ft]	0.0	0.0	0.0
12	Total Losses	[W/ft]	9.08224	9.13685	0.00001
Capacitance, Inductance, Impedance					
13	Capacitance	[μF/mile]	0.44096	0.44096	0.44096
14	Inductance of Conductor	[mH/mile]	0.0	0.0	0.0
15	Reactance of Conductor	[Ω/mile]	0.0	0.0	0.0
16	Inductance of Metallic Sheath	[mH/mile]	0.0	0.0	0.0
17	Reactance of Metallic Sheath	[Ω/mile]	0.0	0.0	0.0
18	Positive Sequence Impedance	[Ω/mile]	0.013551 + j0.000000	0.013551 + j0.000000	0.012215 + j0.000000
19	Negative Sequence Impedance	[Ω/mile]	0.013551 + j0.000000	0.013551 + j0.000000	0.012215 + j0.000000
20	Zero Sequence Impedance	[Ω/mile]	0.266459 + j0.000000	0.266459 + j0.000000	0.266459 + j0.000000
21	Surge Impedance	[Ω]	0.00001	0.00001	0.00001
Others					
22	Dielectric Stress at Conductor Surface	[kV/in]	568.56764	568.56764	568.56764
23	Dielectric Stress at Insulation Surface	[kV/in]	342.74218	342.74218	342.74218
24	Insulation Resistance at 60°F (15.8°C)	[MΩ.1000ft]	4396.29159	4396.29159	4396.29159
25	Reduction Factor		0.0	0.0	0.0
26	Charging Current for One Phase	[A/mile]	0.0001	0.0001	0.0001
27	Charging Capacity of three phase system at Uo	[kvar/mile]	0.11365	0.11365	0.11365
28	Voltage drop for Three Phase System	[V/A/mile]	0.02346	0.02346	0.02117
29	Induced Voltage (standing) on Sheath	[V/mile]	n/a	n/a	n/a
30	Induced current on Metallic Screen	[A]	0.0	0.0	0.0

CONFIDENTIAL



Mears Group, Inc.

A QUANTA SERVICES COMPANY

±320 kV HVDC UG Transmission Line - Kennebec River Crossing

A planned Horizontal Directional Drill (HDD), approximately 2,900 feet in length and 360 feet in depth, would be utilized for the crossing of the Kennebec River with a high voltage underground transmission line to install a duct bank consisting of three (3) ten-inch (10") ducts, one (1) four-inch (4") duct, and two (2) two-inch (2") ducts (all HDPE).

It is anticipated that the HDD could be accomplished within the proposed overhead transmission line corridor, which is 300 feet in width, with a thirty-six inch (36") bore annulus. The bore would pass beneath the Kennebec River with around thirty-feet (30') of clearance from the river bottom.

Mears Group, Inc. - Horizontal Directional Drilling/Direct Pipe®

5051 Westheimer Road, Suite 1650 - Houston, TX 77056 - 281.448.2488 – www.mearsHDD.net

Certified in Safety, Quality & Environment: OHSAS 18001:2007, ISO 9001:2015 and ISO 14001:2004

CONFIDENTIAL

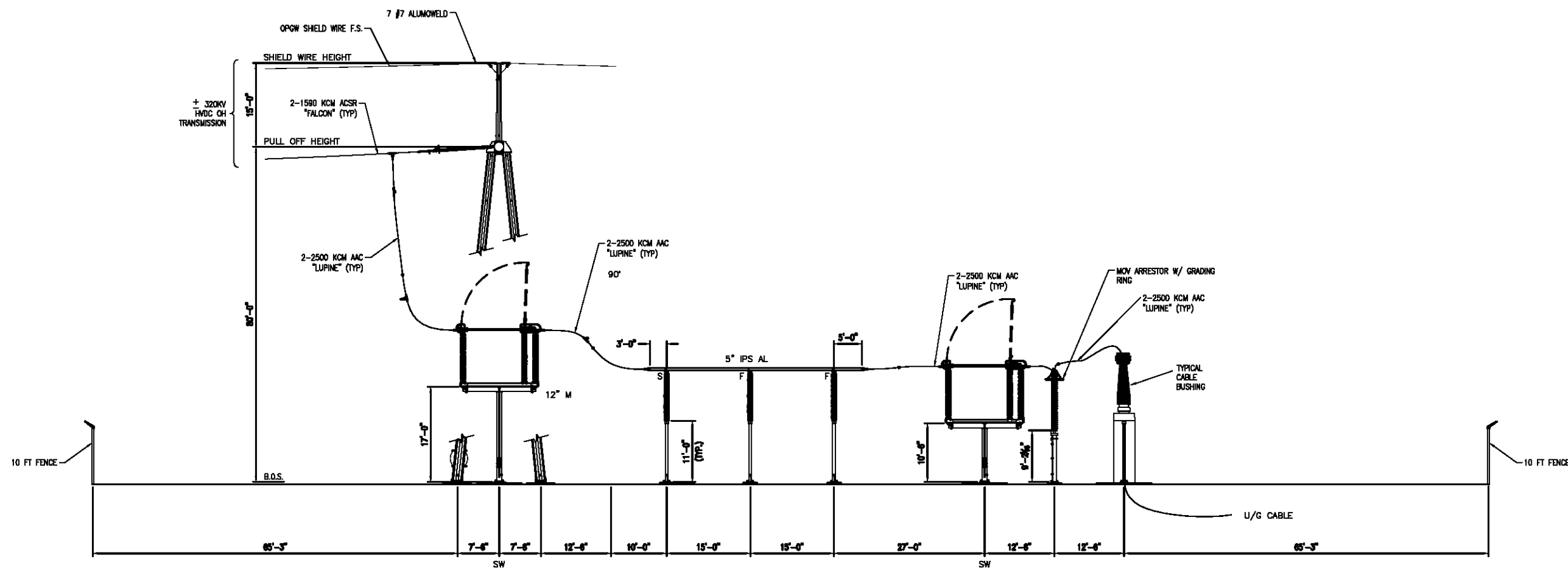

ELEVATION A-A

NOTE
 1. SPARE Hyd. CABLE TO BE ENERGIZED FROM EITHER POLE FOR LONG TERM CABLE CARE

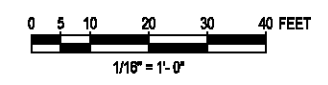

**PRELIMINARY
 NOT FOR
 CONSTRUCTION**

CMP-CON-ELEV.DWG

THIS DRAWING WAS PREPARED BY POWER ENGINEERS, INC. FOR A SPECIFIC PROJECT, TAKING INTO CONSIDERATION THE SPECIFIC AND UNIQUE REQUIREMENTS OF THE PROJECT. REUSE OF THIS DRAWING OR ANY INFORMATION CONTAINED IN THIS DRAWING FOR ANY PURPOSE IS PROHIBITED UNLESS WRITTEN PERMISSION FROM BOTH POWER AND POWER'S CLIENT IS OBTAINED.

REV	REVISIONS	DATE	DRN	DSGN	CKD	APPD	REFERENCE DRAWINGS

DSGN	PEI	*
DRN	*	*
CKD	*	*
SCALE:		3/32"=1'-0"
FOR 22&4 DWG ONLY		



CENTRAL MAINE POWER	JOB NUMBER	REV
NEW ENGLAND CLEAN ENERGY CONNECT PROPOSED KENNEBEC RIVER CROSSING	144357	△
CONCEPTUAL UNDERGROUND LINE UG CABLE TERMINATION STATION TYPICAL ELEVATION	DRAWING NUMBER	CMP-CON-ELEV

CONFIDENTIAL

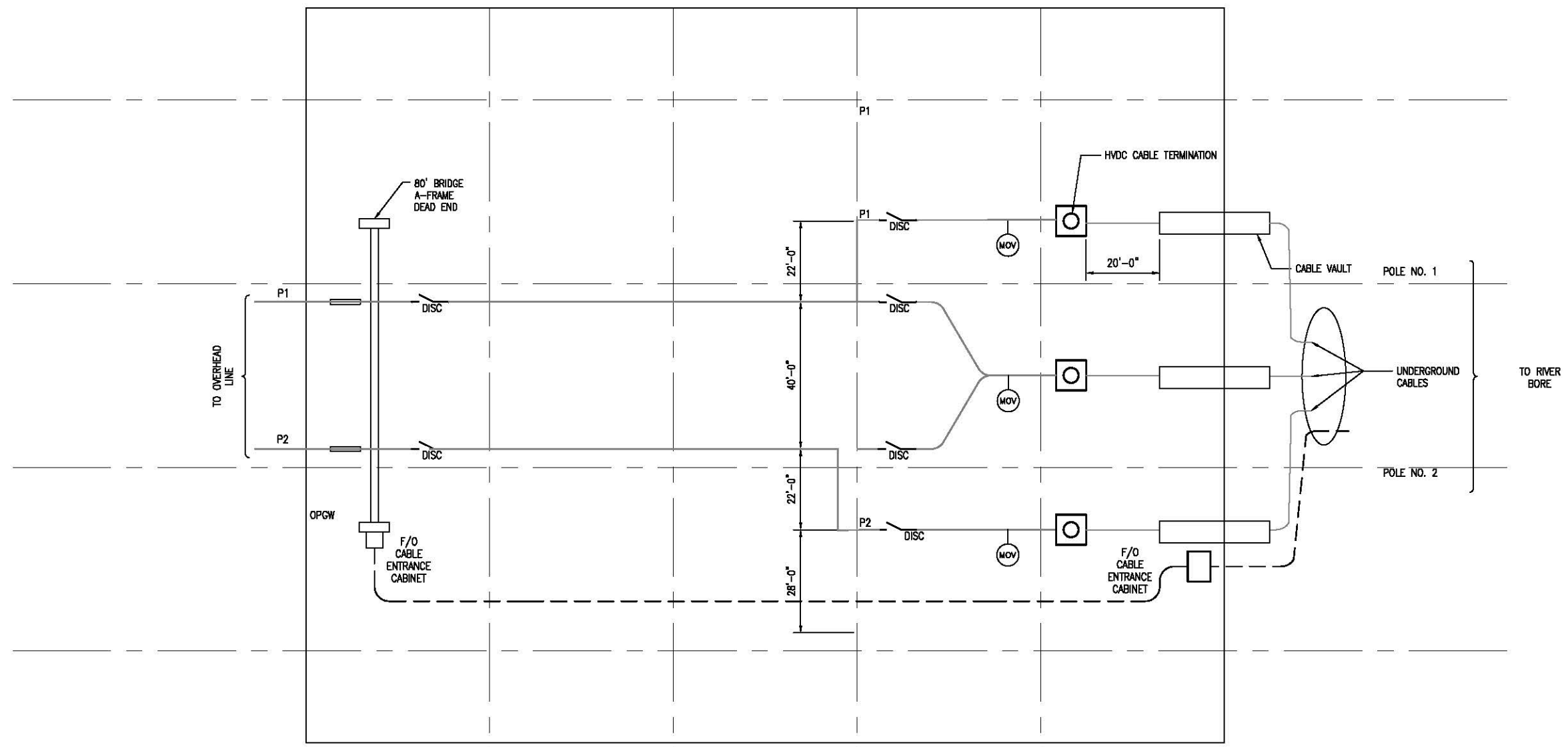

NOTE
 1. SPARE HVDC CABLE TO BE ENERGIZED FROM EITHER POLE FOR LONG TERM CABLE CARE

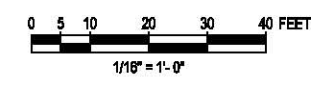

**PRELIMINARY
 NOT FOR
 CONSTRUCTION**

CMP-UG-GL DWG

THIS DRAWING WAS PREPARED BY POWER ENGINEERS, INC. FOR A SPECIFIC PROJECT, TAKING INTO CONSIDERATION THE SPECIFIC AND UNIQUE REQUIREMENTS OF THE PROJECT. REUSE OF THIS DRAWING OR ANY INFORMATION CONTAINED IN THIS DRAWING FOR ANY PURPOSE IS PROHIBITED UNLESS WRITTEN PERMISSION FROM BOTH POWER AND POWER'S CLIENT IS GRANTED.

REV	REVISIONS	DATE	DRN	DSGN	CKD	APPD	REFERENCE DRAWINGS

DSGN	PEI	*
DRN	*	*
CKD	*	*
SCALE:		1/18"=1'-0"
FOR 28x4 DWG ONLY		



CENTRAL MAINE POWER
 NEW ENGLAND CLEAN ENERGY CONNECT
 PROPOSED KENNEBEC RIVER CROSSING
 CONCEPTUAL UNDERGROUND LINE
 UG CABLE TERMINATION STATION TYPICAL LAYOUT

JOB NUMBER	REV
144357	△
DRAWING NUMBER	
CMP-UG-GL	

CONFIDENTIAL

TOWN OF WEST FORKS PLT

TOWN OF MOXIE GORE

KENNEBEC RIVER

PROPOSED ±320 KV HVDC OVERHEAD TRANSMISSION LINE

NO.	REVISION	DATE	BY	CK	P.E.

THIS DRAWING SHALL BE REVISED ON THE CAD SYSTEM ONLY

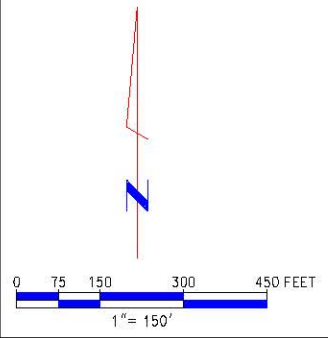

**PRELIMINARY
NOT FOR CONSTRUCTION**

LEGEND

	PROPOSED STRUCTURE LOCATION
	PROPOSED OH TRANSMISSION EXISTING ROW
	TOWN LINE
	PROPERTY LINE
	EDGE OF KENNEBEC RIVER

This document and any attachments are considered:
**BUSINESS CONFIDENTIAL
PROTECTED CRITICAL INFRASTRUCTURE INFORMATION**

REFERENCE DRAWINGS	

NO.	REVISION	DATE	BY	CK	P.E. STAMPED BY	P.E. No.	Professional Engineer Seal
A	ISSUED FOR REVIEW	10/20/17	PEI	CRM			

DESIGNED PEI	<p>NEW ENGLAND CLEAN ENERGY CONNECT PROPOSED KENNEBEC RIVER CROSSING CONCEPTUAL TRANSMISSION LINE ROUTE MAP WEST FORKS PLT & MOXIE GORE, MAINE</p>
DRAWN PEI	
CHECKED PEI	
APPROVED PEI	
REVIEWED	<p>CENTRAL MAINE POWER COMPANY SYSTEM ENGINEERING</p> <p>CENTRAL MAINE POWER DATE: 10/9/17 SCALE: AS NOTED</p>
	<p>SK-KR-RTE-MAP-OP1 REV A</p>

CONFIDENTIAL

DATE	BY	SURVEYED	REVIEWED	ROW	CHKD
PLAN NO.	NOTEBOOK NO.	REVIEWED	ROW	CHKD	

PLAN SCALE:
1" = 150'

This document and any attachments are considered:
BUSINESS CONFIDENTIAL
PROTECTED CRITICAL INFRASTRUCTURE INFORMATION

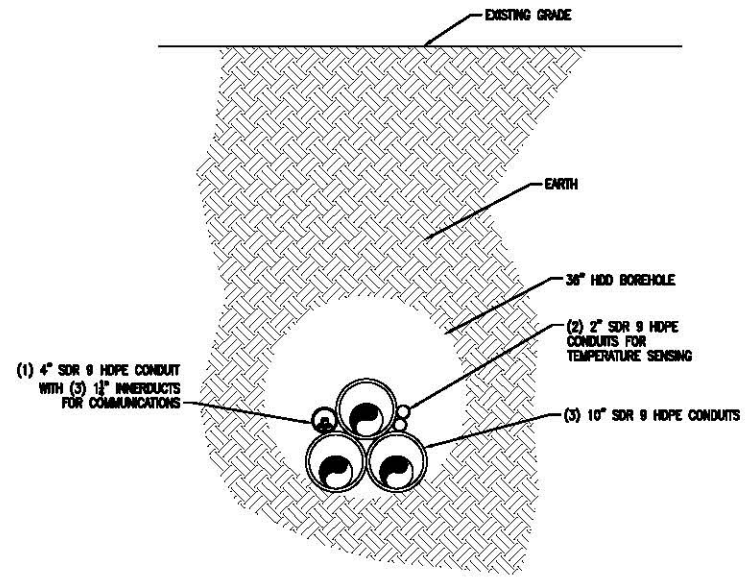
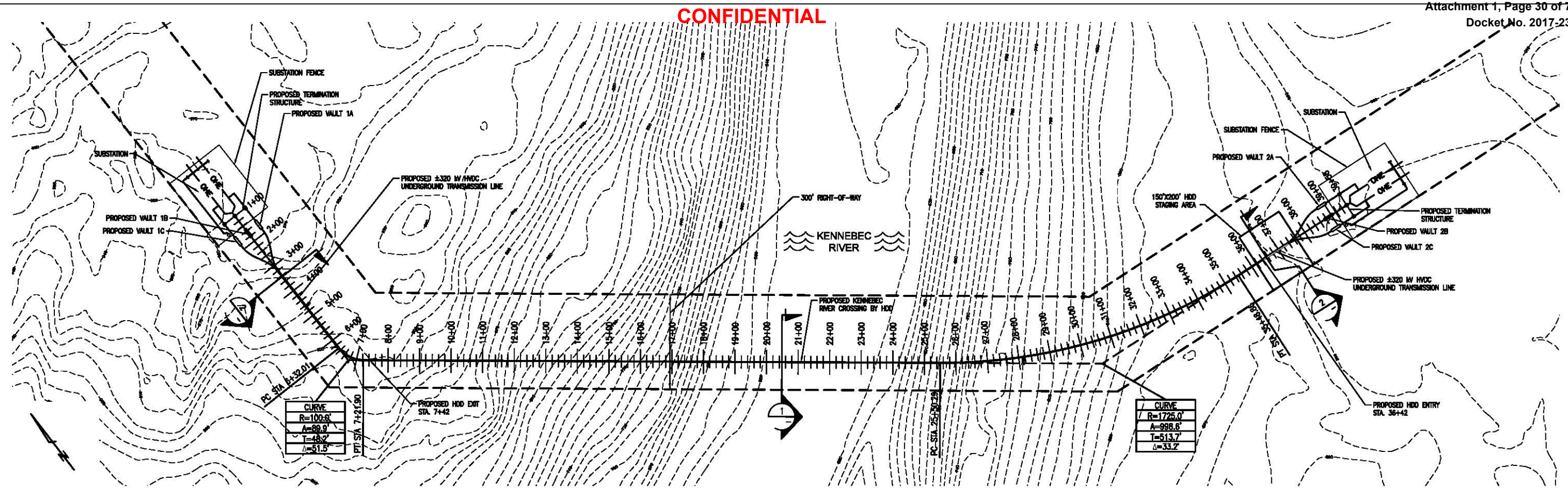

TYP HDD BORE DETAIL
DETAIL
SCALE N.T.S.

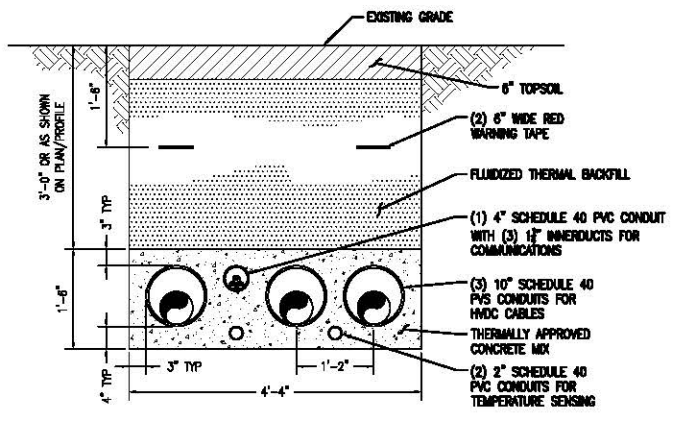

TYP 1X3 TRENCH DETAIL
DETAIL
SCALE N.T.S.

NOTES:
1. THE UTILITIES AND FEATURES SHOWN HEREON ARE BASED ON FIELD SURVEYS, AERIAL PHOTOGRAPHY AND RECORD DOCUMENTS. OTHER FACILITIES MAY EXIST NOT DISCOVERED THROUGH THE RECORD CHECK. THE CONTRACTOR SHALL VERIFY THE EXACT LOCATION, BOTH HORIZONTAL AND VERTICAL, OF ALL UTILITIES THROUGH THE APPROPRIATE UTILITY COMPANIES. CALL BEFORE YOU DIG ~ 1-888-344-7233.

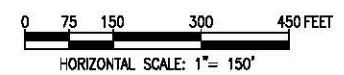

PRELIMINARY
NOT FOR
CONSTRUCTION

DATE	BY	SURVEYED	REVIEWED	NOTES	REDUCED
PROFILE NO.	NOTEBOOK NO.	REVIEWED	NOTES	REDUCED	

THIS DRAWING SHALL BE REVIEWED ON THE CAD SYSTEM ONLY

LEGEND		YR. CONST.		W/O		DESIGNED BY: EE		DRAWN BY: BWF		NEW ENGLAND CLEAN ENERGY CONNECT PROPOSED KENNEBEC RIVER CROSSING CONCEPTUAL UNDERGROUND LINE			
NOTES:						CHECKED BY:		APPROVED BY:					
										CENTRAL MAINE POWER COMPANY DESIGN ENGINEERING			
										MILE OF		REV A	
										DATE OCTOBER 23, 2017		SK-KR-XING.DWG	
NO	REVISION	DATE	BY	CK.	NO	REVISION	DATE	BY	CK.				
					A	ISSUED FOR REVIEW	10/23/17	BA					

November 20, 2017

CENTRAL MAINE POWER

±320 kV HVDC UG Transmission Line Termination Stations Kennebec River Crossing

Reliability Assessment

PROJECT NUMBER:
147483

PROJECT CONTACT:
JESSE SAWIN
LES HINZMAN
MARK REYNOLDS

EMAIL:
JESSE.SAWIN@POWERENG.COM
LES.HINZMAN@POWERENG.COM
MARK.REYNOLDS@POWERENG.COM

PHONE:
(207) 869-1443
(208) 788-0577
(503) 892-6733

Preliminary Reliability Assessment

PREPARED FOR: CMP

PREPARED BY:

MARK A REYNOLDS

(503) 892-6733

MARK.REYNOLDS@POWERENG.COM

APPROVED BY:

LES HINZMAN

(208) 788-0577

LES.HINZMAN@POWERENG.COM

DOCUMENT HISTORY		
DATE	BY	REVISION
09/29/17	Mark A Reynolds P.E.	A – Issued for Review
10/20/17	Mark A Reynolds P.E.	B – Issued for Review
11/20/17	Mark A Reynolds P.E.	C – Issued with Final Report

TABLE OF CONTENTS

Contents

1. GENERAL..... 1

1.1 PROJECT DESCRIPTION..... 1

 1.1.1 Project River Crossing Information Details 1

1.2 CORRESPONDENCE/PROJECT PERSONNEL..... 2

 1.2.1 POWER Engineers, Inc. 2

 1.2.2 CMP..... 2

2. ELECTRICAL DESIGN STANDARDS 3

2.1 SYSTEM REQUIREMENTS 3

2.2 ELECTRICAL CLEARANCES 3

2.3. ELECTRICAL CLEARANCE (+/- 320 HVDC) DESIGN AND WORKING CLEARANCES 4

HORIZONTAL AND VERTICAL SPACING FOR BUSES 4

3. ANALYSIS APPROACH 5

3.1 HVDC TERMINAL AVAILABILITY (VSC EASTERN INVERTER)..... 5

3.2 OVERHEAD TRANSMISSION LINE AVAILABILITY (EASTERN SEGMENT)..... 5

3.3 CABLE TERMINATION STATION AVAILABILITY (EASTERN STATION) 5

3.4 CABLE TERMINATION STATION AVAILABILITY (WESTERN STATION) 6

3.5 CABLE SEGMENT AVAILABILITY (RIVER CROSSING)..... 6

3.7 OVERHEAD TRANSMISSION LINE AVAILABILITY (WESTERN SEGMENT) 6

3.8 HVDC TERMINAL AVAILABILITY (VSC WESTERN RECTIFIER)..... 7

4.1 MTTF/MTTR ASSUMPTIONS..... 7

1. General

1.1 Project Description

The Central Maine Power (CMP) High Voltage Direct Current (HVDC) Transmission Line for the New England Clean Energy Connect (NECEC) Project is a ±320 kV HVDC overhead, single circuit or symmetrical monopole (2-line poles) transmission line capable of transferring 1,200 MW. The project is about 207 miles overall with approximately 145 miles within the US. The line extends through Western Maine from the Appalaches Substation in Thetford Mines, Quebec, Canada and terminates near Lewiston, Maine in the United States. CMP is considering a ±320-kV HVDC underground transmission line for the crossing of the Kennebec River.

The ±320-kV HVDC underground transmission line segment would be installed in lieu of an overhead river crossing span. The project would require two overhead-to-underground Cable Termination (Transition) Stations located near the Kennebec River. In order to achieve the 1,200 Megawatt (MW) rating, each pole will require a 2500 mm² (nearly equivalent to 5,000 kcmil) copper conductor, cross-linked polyethylene (XLPE) insulated underground cable. A spare cable would be installed that could be connected to either pole after only a brief outage should a cable or termination failure occur.

A Horizontal Directional Drill (HDD), approximately 2,900 feet in length and 360 feet in depth, would be utilized for the Kennebec River crossing to install a duct bank consisting of, at a minimum: three (3) ten-inch (10”) ducts, one (1) four-inch (4”) duct, and two (2) two-inch (2”) ducts (all HDPE).

- High Reliability Option (DC) with an inexpensive switching station: One (1) cable per pole at ±320 kV HVDC with (1) spare cable installed:
 - An installed spare cable
 - Necessary Switches to manually switch in the underground cable
 - Limited Access Road to access the switches
 - No control house/P&C equipment auxiliary services

1.1.1 Project River Crossing Information Details

Owner’s Name:	Central Maine Power
Project Name:	NECEC Program, Kennebec River Crossing
Project Location:	Maine
Length:	Approximately 4400 feet (First estimate, subject to change)
Voltage:	±320 kV HVDC
Planned Energization Date:	TBD

2. Electrical Design Standards

2.1 System Requirements

DESCRIPTION	Voltage Class System	
Maximum Phase-to-Phase Voltage	±320 kV	
Basic Impulse Level (BIL)	1300 kV	
Continuous Current, Main Bus	3000	
Ultimate Short Circuit	TBD kA	> 20 kA

2.2 Electrical Clearances

DESCRIPTION	Voltage Class System	
Operating Voltage	±320 kV	
BIL	1300 kV	
Minimum Metal to Metal for Phase to Phase: Recommended:	10'-10" 14'-0"	
Minimum Phase to Ground: Recommended:	9'-7" 11'-6"	
Station Post Insulator Height for Standard Strength	128"	
Min. Conductor Height for Safety:	18'-10"	
Vertical Clearance from Live Parts for Personnel Safety	20'-0"	
Horizontal Clearance from Live Parts for Personnel Safety	13'-4"	
Height of Conductor Over Roadway:	40'-0"	

Minimum Clearances based on IEEE Std 1427-2006

2.3. Electrical Clearance (+/- 320 HVDC) design and working clearances

Rated Maximum Phase to Phase voltage or Pole to Pole (kV) ⁽²⁾	BIL (KV) ⁽²⁾	Minimum Phase to Ground Clearances		Recommended Phase to Ground Clearances	Minimum Phase to Phase Clearances Metal to Metal	Recommended Phase to Phase Centerline Clearances		
		Rigid Parts (in)	Gap for Ground Switch to Live Parts ⁽³⁾ (in)	Rigid Parts (in)	Disc. Switch, Bus Supports, Rigid Conductors (in)	Vertical Break Disc. Switch, Bus Support ⁽⁵⁾ (in)	Horiz. Break Disc. Switch (in)	Horn Gap Switch (in)
±320	1300	104	50	110	155	192	240	240

(Per CMP Table 1 TM2.71.54 Standard with edit for HVDC Operation ± 320 kV)

Horizontal and Vertical Spacing for Busses

DESCRIPTION	Voltage Class System	
Operating Voltage	±320 kV	
BIL	1300 kV	
Low Bus Centerline, Phase to Phase	155 inches	
High Bus Centerline, Phase to Phase	155 inches	
Strain Bus Centerline, Phase to Phase	28'-0"	
Low Bus Height (minimum)	25'-0"	
High Bus Height (minimum)	41'-0"	

3. ANALYSIS APPROACH

3.1 HVDC Terminal Availability (VSC Eastern Inverter)

Current VSC HVDC technology offers overall station availabilities in the range of ~99.5 %, total terminal availability. Symmetrical bi-pole availabilities are different than LCC conventional Terminals due to the characteristics of not being able to fall back to a metallic or earth return configuration during the outage of one pole conductor. So, a single pole disturbance will create an instantaneous Bipole outage. Equipment outages will be predominately AC-equipment caused, including outages of significant voltage reductions to cause commutation failure of the rectifier/inverter converters.

3.2 Overhead Transmission Line Availability (Eastern Segment)

±320 kV HVDC transmission line design should provide an overall reliability figure that is only impaired for lightning caused events. As stated earlier a single line pole outage will result in a full system interruption, due to no fallback to metallic return or ground return configurations. Conservative selection of transmission line HVDC insulators with large creepage lengths (> 50 kV/mm) should provide adequate performance for natural pollution (dust) and unequal wetting, or large rainfall wetting of the outdoor insulation. The probability of outages in this segment will most likely be lightning produced outages, of a temporary nature that in most all cases will self-restore. Statistically about 5 to 7 lightning events may be expected, and each of these events will cause a momentary Bipole loss and reclose events of the range of 1.1 to 1.5 second duration, depending on the line clearing times, cable capacitance and length and where the fault was detected.

Automatic reclosure of the OH line segments would normally occur if there was no faults detected at either of the cable termination stations with both protection channels. If a cable fault was detected the automatic reclosure and startup process would be blocked until the cable termination data could be analysed and a decision made on restarting the energization process. The logic checks for the protection would normally occur in less than 20 to 50 MS, but the release of the blocking signal would normally require resetting appropriate lockouts at the HVDC Terminals and both the Cable Termination Stations. This can be done via SCADA supervisory control, but would still require human intervention, so several minutes 30 to 60 minutes may be spent obtaining fault records and verifying all of the switching (if backup pole cables are available) are properly configured.

3.3 Cable Termination Station Availability (Eastern Station)

The ±320 kV HVDC Cable Termination Station has several elements** that will determine the overall link availability. In order to assess this risk consider the joint probability:

- | | | |
|----|--|--|
| 1. | Incoming HVDC Cable Bushing (vertical) | λ_B (Bushing) = 0.0053 (Failures/yr) |
| 2. | Support Insulators and buswork | λ_{BUS} (System) = 0.0001 (Failures/yr) |
| 3. | MOV (Arrestor) | λ_{MOV} (Arrestor) = 0.0001 (Failure/yr) |
| 4. | Disconnect Switch | λ_{DISC} (Disc) = 0.0097 (Failures/yr.) |

**Data extracted from available *CIGRE failure data 2014*)

Failure Probability of one Current Path

$$P_{\text{pole}} = (1 - \lambda_B) * (1 - \lambda_{\text{BUS}}) * (1 - \lambda_{\text{MOV}}) * (1 - \lambda_{\text{DISC}}) =$$

$$P_{\text{pole}} = (0.9903) * (0.9999) * (0.9999) * (0.9903) = 0.9805 \text{ /year or}$$

$$(0.0195 \times 8760 \text{ hrs/year}) = 170 \text{ (hours of potential outage time)}$$

3.4 Cable Termination Station Availability (Western Station)

The ±320 kV HVDC Cable Termination Station has several elements** that will determine the overall link availability. In order to assess this risk consider the joint probability:

- | | |
|---|--|
| 6. Incoming HVDC Cable Bushing (vertical) | $\lambda_B(\text{Bushing}) = 0.0053 \text{ (Failures/yr.)}$ |
| 7. Support Insulators and buswork | $\lambda_{\text{BUS}}(\text{System}) = 0.0001 \text{ (Failures/yr.)}$ |
| 8. MOV (Arrestor) | $\lambda_{\text{MOV}}(\text{Arrestor}) = 0.0001 \text{ (Failure/yr.)}$ |
| 9. Disconnect Switch | $\lambda_{\text{DISC}}(\text{Disc}) = 0.0097 \text{ (Failures/yr.)}$ |

**Data extracted from available *CIGRE failure data 2014*

Failure Probability of one Current Path

$$P_{\text{pole}} = (1 - \lambda_B) * (1 - \lambda_{\text{BUS}}) * (1 - \lambda_{\text{MOV}}) * (1 - \lambda_{\text{DISC}}) =$$

$$P_{\text{pole}} = (0.9903) * (0.9999) * (0.9999) * (0.9903) = 0.9805 \text{ /year or}$$

$$(0.0195 \times 8760 \text{ hrs/year}) = 170 \text{ (hours of potential outage time)}$$

3.5 Cable Segment Availability (River Crossing)

From publically available sources of about 99.5 % (see section 4.2 below)

3.7 Overhead Transmission Line Availability (Western Segment)

From publically available sources availability of about is assumed 99.977 % (see section 4.2 below)

3.8 HVDC Terminal Availability (VSC Western Rectifier)

Assuming that the rectifier station has the same technology as the Eastern Inverter Station, Current VSC HVDC technology offers overall station availabilities in the range of ~99.5 %, total terminal availability. Symmetrical bi-pole availabilities are different than LCC conventional Terminals due to the characteristics of not being able to fall back to a metallic or earth return Configuration during the outage of one pole conductor. So, a single pole disturbance will create an instantaneous Bipole outage. Equipment outages will be predominately AC-equipment caused, including outages of significant voltage reductions to cause commutation failure of the rectifier/inverter converters.

4. OVERVIEW SYSTEM AVAILABILITY

4.1 MTTF/MTTR Assumptions

The HVDC VSC Inverter and Rectifier terminals are described and not under this part of the project scope. However, several assumptions were made to make the reliability estimates in this report, and are in summary below:

- a. MTTF/MTTR are heavily influenced by the ability to have the appropriate trained staff, protected spare parts available to the maintainers/repair staff, and full observable of the remote HVDC Cable Termination Stations. Video surveillance combined with full alarm and control point observability from both HVDC Terminal Stations will provide in most cases the means to diagnose any cable or transmission line impairments, and allow system operators to make the proper operating decisions.
- b. VSC operation during fault recovery needs to be completely tested during FAT (Factory System Testing) and should be tested and timing during all possible impairments. Of particular interest is how long the automated fault location, isolation and reconfiguration process will take (along with the HMI reaction delays)
- c. Due to weather conditions at the Cable Termination Stations during the weather, strategically located parts need to be warehoused either on site or at the nearest convenient township in a protected, secured, and accessible (7 x 24) location.

Spares should consist of at least the following parts for the cable termination station

- Spare insulators for all support and Disconnects
- Spare MOV surge arrestor
- Spare cable splice kits and re-termination kit
-

4.2 Combined Cable System Reliability Figure

The HVDC SC Inverter and Rectifier joint availability is about (according to recent discussions with OEM Suppliers):

99.0 %

Each Cable Termination Station has an availability calculated from typical values (as shown in the report):

98.04 %

Or a joint probability of $(0.9804)^2 = 0.9614$ or about 96.14 %.

The cable segment should have a reliability

of: $(1.0 - 0.0050) = 0.995$ or about 99.5 %

The overhead line segments have not been evaluated in this report but typical high performance ± 320 kV HVDC lines with conservative insulation systems should be in the order of:

Line length of 145 miles (figure the typical outage of 1 outage per 100 miles), so:

$145/100 = 1.45$ outages per year (from all causes but most probably lightning)

The usual approach is to round off to the next whole number of in this case 2.0 outages per year or:

$2/8760 = 0.000228$ (assuming short < 1 hour) duration self clearing faults or 0.0028 % per year or in availability $1.0 - 0.000228 = 99.977$ %

So, an overall availability (without considering MTTR (Mean Time to Repair) :

$(\text{OH Line Segment}) * (\text{Cable Segment}) * (\text{Termination Stations}) * (\text{HVDC Stations})$

$(0.9997) * (0.995) * (0.9614) * (0.990) = 0.9467$ or about **467 hours of unavailability (worst case) per year for self-restored faults.**

If we use figures on typical restoration activities than a MTTR can be calculated, however please note that HVDC cable faults are usually if not always non-restorable without removal and replacement of at least one of the pole conductors. (Please see other documents on MTTR estimates)

4.3 MTTR Considerations for UG Repair* (from POWER's Cable Specialists)**

In the event of a cable failure: 26 to 29 days; best case scenario, no contingency.
Mobilize Electrical Contractor, isolate the failed cable: 1-2 days
Remove terminations using man-lift and remove cable end to end – 3 days
Proof conduit and camera inspection of duct system – 3 days
If conduit is damaged and the spare must be used; time for routing spare to damaged cable termination position – 8 to 10 days
Replace a cable between termination structures – 2 days
Install terminations – 6 days
Test and energize – 3 days

In the event of a termination failure: 19 - 20 days; best case scenario, no contingency, assumes no civil work.
Mobilize Contractor, isolate the failed cable: 1-2 days
Mobilize UG T-Line Contractor with equipment: 5 days
Remove termination using man-lift and cable to pull-through vault – 2 days
Replace a short piece of cable between the pull-through vaults to the termination structure – 2 days
Install termination – 3 days
Install splice – 3 days
Test and energize – 3 days

***Assuming no installed spare cable. Spare materials are stored on site and an agreement would be in place for Contractors to mobilize immediately; no inclement weather or poor access conditions have been considered.

NOTE: This scenario explored in 4.3 above illustrates why CMP elected to install a spare cable in the final report

November 20, 2017

CENTRAL MAINE POWER

±320 kV HVDC UG Transmission Line Kennebec River Crossing

Design Information Package

PROJECT NUMBER:
147483

PROJECT CONTACT:
LES HINZMAN **EMAIL:**
LES.HINZMAN@POWERENG.C
OM PHONE:
(208) 788-0577



Design Information Package

PREPARED FOR: CMP

PREPARED BY:

LES HINZMAN
(208) 788-0577
LES.HINZMAN@POWERENG.COM

APPROVED BY:

-
-
-

DOCUMENT HISTORY		
DATE	BY	REVISION
09/11/17	Les Hinzman	A – Issued for Review
09/29/17	Les Hinzman	B – Issued for Review
10/20/17	Les Hinzman	C – Issued for Review
11/20/17	Les Hinzman	D – Issued with Final Report

TABLE OF CONTENTS

1.0 GENERAL 1

1.1 PROJECT INFORMATION 1

1.2 CORRESPONDENCE/PROJECT PERSONNEL..... 1

 1.2.1 POWER Engineers, Inc. 1

 1.2.2 CMP..... 1

1.3 PROJECT DESCRIPTION..... 2

2.0 ROUTE DESCRIPTION 2

2.1 ROUTE 2

2.2 MINIMUM EASEMENT REQUIREMENTS 3

3.0 UNDERGROUND SYSTEM PARAMETERS 3

3.1 CABLE SYSTEM OPERATING PARAMETERS 3

3.2 UNDERGROUND CABLE INSTALLATION PARAMETERS..... 3

 3.2.1 XLPE Cable System (Open Trench and HDD) 3

4.0 ELECTRICAL SYSTEM DESIGN CRITERIA 4

4.1 CODES AND STANDARDS 4

4.2 UNDERGROUND CABLE AND ACCESSORIES 4

 4.2.1 Cable..... 4

 4.2.2 Cable Splices 4

 4.2.3 Splice Manholes (Pull-through)..... 5

1.0 GENERAL

1.1 Project Information

Owner's Name: Central Maine Power
Project Name: NECEC Program, Kennebec River Crossing
Project Location: Maine
Length: Approximately 4400 feet
Voltage: ±320 kV HVDC
Planned Energization Date: TBD

1.2 Correspondence/Project Personnel

1.2.1 POWER Engineers, Inc.

Project Manager Russ Clavette
Email: russ.clavette@powereng.com
Phone: (207) 869-1202
Address: 303 US Route One Freeport, ME 04032

Project Engineer (Stations) Jesse Sawin
Email: jesse.sawin@powereng.com
Phone: (207) 869-1443
Address: 303 US Route One
Freeport, ME 04032

Project Engineer (UG) Les Hinzman
Email: les.hinzman@powereng.com
Phone: (208) 788-0577
Address: 3940 Glenbrook Dr.
Hailey, ID 83333

Project Engineer (Transition Station) Mark Reynolds
Email: mark.reynolds@powereng.com
Phone: (503) 892-6733
Address: 9320 SW Barbur Blvd, Suite 200
Portland, OR 97219

1.2.2 CMP

Project Manager Justin Tribbet
Email: Justin.Tribbet@cmpco.com
Phone: (207) 629-2010
Address: 83 Edison Dr.
Augusta, ME 04336

1.3 Project Description

The Central Maine Power (CMP) High Voltage Direct Current (HVDC) Transmission Line for the New England Clean Energy Connect (NECEC) Project is a ± 320 kV HVDC overhead, single circuit or symmetrical monopole (2-line poles) transmission line capable of transferring 1,200 MW. The project is about 207 miles overall with approximately 145 miles within the US. The line extends through Western Maine from the Appalaches Substation in Thetford Mines, Quebec, Canada and terminates near Lewiston, Maine in the United States. CMP is considering a ± 320 -kV HVDC underground transmission line for the crossing of the Kennebec River.

The projects includes two Cable Termination Substations near the Kennebec River. A planned 2,900 foot Horizontal Directional Drill would be utilized with 1500 feet of direct buried concrete encased duct bank consisting of three (3) ten-inch (10") ducts one (1) four-inch (4") duct, and two (2) two-inch (2") ducts (all HDPE) for the crossing of the Kennebec River with two (2) poles and an installed spare for the ± 320 kV HVDC underground transmission line to include ducts for fiber optic cables and distributed temperature sensing.

- High Reliability Option (DC) with an inexpensive switching station: One (1) cable per pole at ± 320 kV HVDC with (1) spare cable installed:
 - An installed spare cable
 - Necessary Switches to manually switch in the underground cable
 - Limited Access Road to access the switches
 - No control house/P&C equipment auxiliary services

2.0 ROUTE DESCRIPTION

A Horizontal Directional Drill (HDD), approximately 2,900 feet in length and 360 feet in depth, would be utilized for the Kennebec River crossing to install a duct bank consisting of, at a minimum: three (3) ten-inch (10") ducts, one (1) four-inch (4") duct, and two (2) two-inch (2") ducts (all HDPE).

It is anticipated that the HDD could be accomplished with a thirty-six inch (36") bore annulus within the proposed overhead transmission line corridor, which is 300 feet in width. The bore would pass beneath the Kennebec River with approximately thirty-feet (30') of clearance from the river bottom.

The HVDC underground cable installation would require approximately fifteen-hundred feet (1500') of open trenching to connect to the Cable Termination Stations.

2.1 Route

Approx. 2900’ drill with approximately 1,500’ open trench.

2.2 Minimum Easement Requirements

Property Easement: 300’ existing easement intended for overhead transmission line

3.0 UNDERGROUND SYSTEM PARAMETERS

3.1 Cable System Operating Parameters

The underground cable system will be operated under the following requirements:

Nominal Voltage	±320 kV
Nominal Frequency	DC
Maximum Steady State Load	1200 MVA

3.2 Underground Cable Installation Parameters

The cable system will require a horizontal directional drill with open trenching leading a transition station on either side.

3.2.1 XLPE Cable System (Open Trench and HDD)

The majority of the overall route will be installed using open cut trenching construction methods. The open cut trenching construction will be designed based on the following criteria.

Minimum Burial Depth to Top of Conduit	36 inches
Minimum Sweep Radius	12 feet
Ambient Soil Temperature (Assumed)	6°C
Native Soil Thermal Resistivity (Assumed)	80°C-cm/W at 6% moisture
Bentonite Drilling Fluid Thermal Resistivity (Assumed)	140°C-cm/W at 6% moisture

4.0 ELECTRICAL SYSTEM DESIGN CRITERIA

4.1 Codes and Standards

The system electrical design for the underground lines shall be in accordance with the latest revision of all applicable industry codes and standards as well as applicable regulations of the Federal, State, and Local authorities.

The following codes that will be used are as follows:

- National Electrical Safety Code 2017
- AEIC CS9-2015
- Cigre TB-496-2012
- ICEA S-108-720-2012
- ICEA P-45-482-2007
- IEC 62067-2011

4.2 Underground Cable and Accessories

This section describes the cable and accessories that will be used for the underground electrical system. All accessories will be designed and verified to accommodate the cable construction described below via a qualified type test in accordance with IEC 141-1

4.2.1 Cable

Cable Type (Solid Dielectric, HPFF, etc.)	Solid Dielectric
Voltage Class	±320 kV HVDC
Conductor Size	2,500 mm ²
Conductor Type and Construction	Compact segmented or circular copper
Insulation Material	XLPE
Insulation Thickness	21.5 mm (approx.)
Shield Type	Copper Laminate
Jacket Type	HDPE
Fault Current Magnitude	TBD
Fault Current Duration	TBD
Minimum Bend Radius	TBD
Supplied by	TBD

4.2.2 Cable Splices

Splice Style	TBD
Voltage Class	±320 kV HVDC
Quantity	(Spares TBD)
BIL	1300 kV

Supplied by TBD
Comments: Cable splices are not required on initial installation; spare splices are to be kept in stores to avoid long lead-times.

4.2.3 Splice Manholes (Pull-through)

Splice Manhole Type (Precast or Cast in Place) Precast
Splice Manhole Size (L' x W' x H' outside) TBD
Number of Circuits per Manhole TBD
Number of Splicing Manholes 6 Pull-Through Vaults
Minimum Cover 24"
Number of Access Lids 2
Vault Spacing TBD
Vault Loading Requirements (H-20, etc.) H-20
Supplied by Underground Civil Contractor
Comments

November 20, 2017

CENTRAL MAINE POWER

±320 kV HVDC UG Transmission Line Termination Stations Kennebec River Crossing

Design Criteria Package

PROJECT NUMBER:
147483
PROJECT CONTACT:
MARK REYNOLDS
EMAIL:
MARK.REYNOLDS@POWERENG.COM
PHONE:
(503) 892-6733

PROJECT CONTACT:
LES HINZMAN **EMAIL:**
LES.HINZMAN@POWERENG.C
OM PHONE:
(208) 788-0577



Preliminary Design Criteria Package

PREPARED FOR: CMP

PREPARED BY:

MARK A REYNOLDS

(503) 892-6733

MARK.REYNOLDS@POWERENG.COM

APPROVED BY:

-
-
-

DOCUMENT HISTORY		
DATE	BY	REVISION
09/21/2017	Mark A Reynolds P.E.	A – Issued for Review
09/22/2017	Mark A Reynolds P.E.	B – Revised from first comments
10/19/2017	Mark A Reynolds P.E.	C – Revised to final option
11/20/2017	Mark A Reynolds P.E.	D – Issued with Final Report

TABLE OF CONTENTS

Contents

1. GENERAL 1

1.1 PROJECT DESCRIPTION 1

 1.1.1 Project River Crossing Information Details 1

1.2 CORRESPONDENCE/PROJECT PERSONNEL 2

 1.2.1 POWER Engineers, Inc. 2

 1.2.2 CMP..... 2

2. CODES AND STANDARDS 3

2.1 TRANSMISSION STANDARDS INCLUDING CLIMATE & ENVIRONMENTAL DOCUMENTS 3

3. ELECTRICAL DESIGN STANDARDS 4

3.1 SYSTEM REQUIREMENTS 4

3.2 ELECTRICAL CLEARANCES..... 4

13. ELECTRICAL CLEARANCE (+/- 320 HVDC), DESIGN AND WORKING CLEARANCES..... 5

3.3 HORIZONTAL AND VERTICAL SPACING FOR BUSES..... 5

4. ELECTRICAL DESIGN PARAMETERS 5

4.1 RIGID BUS 5

4.2 JUMPER BUS 6

4.3 STRAIN BUS..... 6

5. STRUCTURES 6

6.0 FOUNDATIONS AND CONCRETE 6

6.1 FOUNDATION TYPE & APPLICATION 6

6.2 FOUNDATION DESIGN PARAMETERS..... 7

6.3 CONCRETE & ANCHOR BOLTS 7

7. GROUNDING..... 7

7.1 GROUND GRID DESIGN REQUIREMENTS 8

8. FENCING 8

8.1 MAIN FENCE TYPE & MATERIAL..... 9

9. LOW VOLTAGE CABLE (600V & BELOW)..... 9

9.1 CONTROL CABLE 9

9.2 FIBER OPTIC ADSS/DIELECTRIC CABLE 9

10. CONDUIT & CABLE TRENCH REQUIREMENTS 9

10.1 CABLE TRENCH 9

10.2 CONDUIT SYSTEM..... 10

10.3 SPLICE VAULTS (PULL-THROUGH & OTHER APPLICATIONS)..... 10

11. SUBSTATION LIGHTING..... 10

12.	SUBSTATION LIGHTNING PROTECTION.....	11
13.	WIND LOADING CRITERIA.....	11
14.	MAXIMUM ICING (RADIAL COATING TO ASSUME).....	11
15.	EXPECTED LIGHTNING PROBABILITIES	11
16.	POLLUTION LEVELS (INCLUDING DUST BORNE CAUSED)	11
17.	TEMPERATURE EXTREMES	12
18.	HUMIDITY EXTREMES	12
19.	SNOWFALL MAXIMUM.....	12
20.	RAINFALL MAXIMUM.....	12
21.	SEISMIC LEVELS (IEEE 693, MOST PROBABLY “LOW PERFORMANCE” IN THIS LOCATION).....	13
22.	OIL CONTAINMENT (AS PERTAINING TO DOUBLE WALL ALARMED OIL STORAGE TANK SYSTEM)	13
23.	STATION SECURITY VIDEO SURVEILLANCE, AND INTRUSION ALARMING.....	14
24.	TELECOMMUNICATIONS & PROTECTION & CONTROL OVERVIEW	14
25.	PREFABRICATED SUBSTATION BUILDINGS (EEE) & ASSOCIATED AUXILIARY POWER SYSTEMS	14

1. General

1.1 Project Description

The Central Maine Power (CMP) High Voltage Direct Current (HVDC) Transmission Line for the New England Clean Energy Connect (NECEC) Project is a ± 320 kV HVDC overhead, single circuit or symmetrical monopole (2-line poles) transmission line capable of transferring 1,200 MW. The project is about 207 miles overall with approximately 145 miles within the US. The line extends through Western Maine from the Appalaches Substation in Thetford Mines, Quebec, Canada and terminates near Lewiston, Maine in the United States. CMP is considering a ± 320 -kV HVDC underground transmission line for the crossing of the Kennebec River.

The project includes two Cable Termination Substations near the Kennebec River. A planned 2,900 foot Horizontal Directional Drill would be utilized with 1500 feet of direct buried concrete encased duct bank consisting of three (3) ten-inch (10”) ducts one (1) four-inch (4”) duct, and two (2) two-inch (2”) ducts (all HDPE) for the crossing of the Kennebec River with two (2) poles and an installed spare for the ± 320 kV HVDC underground transmission line to include ducts for fiber optic cables and distributed temperature sensing.

High Reliability Option (DC) with an inexpensive switching station: One (1) cable per pole at ± 320 kV HVDC with (1) spare cable installed:

- An installed spare cable
- Necessary Switches to manually switch in the underground cable
- Limited Access Road to access the switches
- No control house/P&C equipment auxiliary services

1.1.1 Project River Crossing Information Details

Owner’s Name:	Central Maine Power
Project Name:	NECEC Program, Kennebec River Crossing
Project Location:	Maine
Length:	Approximately 4400 feet (First estimate subject to change)
Voltage:	± 320 kV HVDC
Planned Energization Date:	TBD

1.2 Correspondence/Project Personnel

1.2.1 POWER Engineers, Inc.

Project Manager
Russ Clavette
Email: russ.clavette@powereng.com
Phone: (207) 869-1202
Address: 303 US Route One Freeport, ME 04032

Project Engineer
(Stations)
Jesse Sawin
Email: jesse.sawin@powereng.com
Phone: (207) 869-1443
Address: 303 US Route One
Freeport, ME 04032

Project Engineer
(Transition Station)
Mark Reynolds
Email: mark.reynolds@powereng.com
Phone: (503) 892-6733
Address: 3 Centerpointe Drive Suite 500
Lake Oswego, OR 97035-8663

Project Engineer
(Underground T-Line) Email:
Les Hinzman
Email: les.hinzman@powereng.com
Phone: (208) 788-0577
Address: 3940 Glenbrook Dr.
Hailey, ID 83333

1.2.2 CMP

Project Manager
Justin Tribbet
Email: Justin.Tribbet@cmpco.com
Phone: (207) 629-2010
Address: 83 Edison Dr.
Augusta, ME 04336

2. Codes and Standards

2.1 Transmission Standards including Climate & Environmental Documents

A summary of the codes, industry standards, and guides to be used are included below, including IEEE Standards and Owner Specific Standards (as available).

AASHTO	American Association of State and Highway Transportation Officials
ACI	American Concrete Institute
AGA	American Galvanizers Association
AISC	American Institute of Steel Construction
ANSI	American National Standards Institute
ASCE	American Society of Civil Engineers
ASME	American Society of Mechanical Engineers
ASTM	American Society for Testing and Materials
AWS	American Welding Society
CFR	Code of Federal Regulations
IBC	International Building Code
IEC	International Electrotechnical Commission
IEEE	Institute of Electrical and Electronics Engineers
MBC	Minnesota Building Code
MBMA	Metal Building Manufacturers Association
NEC	National Electric Code, 2014 Edition
NEMA	National Electrical Manufacturers Association
NESC	National Electric Safety Code, C2-2012
NFPA	National Fire Protection Association
OSHA	Occupational Safety and Health Organization

The current revision of all relevant standards shall apply (unless otherwise noted) including:

AASHTO:	Standard for Aggregates
ANSI:	C2 – National Electrical Safety Code (2012)
ASCE:	113 – Substation Structure Design Guide (2008)
IEEE:	80 – Guide for Safety in AC Substation Grounding
	525 – Guide for the Design and Installation of Cable Systems in Substations
	605 – Guide for Design of Substation Rigid Bus Structures
	693 – Recommended Practice for Seismic Design of Substations
	998 – Guide for Direct Lightning Stroke Shielding of Substations
NFPA:	70 – National Electric Code
MBC:	Maine Building Code (2015 or latest edition)
OSHA:	1910.269 – Electric Power Generation, Transmission, and Distribution, Law and Regulations
IEC	IEC 60815 Guide for the Selection of Insulators in Respect of Polluted Levels

The current revision of all relevant standards form CMP shall apply (unless otherwise noted) including:

<p>CMP TM 2.71.345 CMP 2.72.64 CMP 2.72.65-103</p> <p>CMP 2.71.9 (Series)</p> <p>CMP TM 2.71.08 (Rev 2) CMP TM 2.73.19</p> <p>CMP TM 2.71.11</p> <p>CMP TM 2.71.77</p> <p>CMP TM 2.71.54</p> <p>CMP TM 2.71.53</p>	<p><i>CMP Structural Steel Standards</i> <i>CMP Structural Steel Standards</i> <i>CMP Structural Steel Standards</i></p> <p><i>CMP Foundations Standards</i></p> <p><i>CMP Control Building Standards</i> <i>CMP Control House Electrical Standards</i></p> <p><i>CMP Lighting Standards</i></p> <p><i>CMP Grounding Standards</i></p> <p><i>CMP Electrical Clearance Standards</i></p> <p><i>CMP Bus Design Standards</i></p>
--	--

3. Electrical Design Standards

3.1 System Requirements

DESCRIPTION	Voltage Class System	
Maximum Phase-to-Phase Voltage	±320 kV	
Basic Impulse Level (BIL)	1300 kV	
Continuous Current, Main Bus	3000 A	
Ultimate Short Circuit	TBD kA	> 20 kA

3.2 Electrical Clearances

DESCRIPTION	Voltage	
Operating Voltage	±320 kV	
BIL	1300 kV	
Minimum Metal to Metal for Phase to Phase: Recommended:	10'-10" 14'-0"	
Minimum Phase to Ground: Recommended:	9'-7" 11'-6"	
Station Post Insulator Height for Standard Strength	128"	
Min. Conductor Height for Safety:	18'-10"	
Vertical Clearance from Live Parts for Personnel Safety	20'-0"	
Horizontal Clearance from Live Parts for Personnel Safety	13'-4"	
Height of Conductor Over Roadway:	40'-0"	

Minimum Clearances based on IEEE Std 1427-2006

13. Electrical Clearance (+/- 320 HVDC), design and working clearances

Rated Maximum Phase to Phase voltage or Pole to Pole (kV) ⁽²⁾	BIL (KV) ⁽²⁾	Minimum Phase to Ground Clearances		Recommended Phase to Ground Clearances	Minimum Phase to Phase Clearances Metal to Metal	Recommended Phase to Phase Centerline Clearances		
		Rigid Parts (in)	Gap for Ground Switch to Live Parts ⁽³⁾ (in)	Rigid Parts (in)	Disc. Switch, Bus Supports, Rigid Conductors (in)	Vertical Break Disc. Switch, Bus Support ⁽⁵⁾ (in)	Horiz. Break Disc. Switch (in)	Horn Gap Switch (in)
±320	1300	104	50	110	155	192	240	240

(Per CMP Table 1 TM2.71.54 Standard with edit for HVDC Operation ± 320 kV)

3.3 Horizontal and Vertical Spacing for Busses

DESCRIPTION	Voltage	
Operating Voltage	±320 kV	
BIL	1300 kV	
Low Bus Centerline, Phase to Phase	155 inches	
High Bus Centerline, Phase to Phase	155 inches	
Strain Bus Centerline, Phase to Phase	28'-0"	
Low Bus Height (minimum)	25'-0"	
High Bus Height (minimum)	41'-0"	

4. ELECTRICAL DESIGN PARAMETERS

4.1 Rigid Bus

DESCRIPTION	VOLTAGE	
Nominal Voltage:	±320 kV	
Type (Tube, Other):	Al Tube	
Ampacity:	3000A	(CMP Standard)
Material / Alloy:	6063-T6	
Short Circuit Current:	TBD kA	> 20 kA

4.2 Jumper Bus

DESCRIPTION	VOLTAGE	
Nominal Voltage:	±320 kV	
Ampacity:	3000A	(CMP Standard)
Connections (Compression / Bolted / Welded):	TBD	

4.3 Strain Bus

DESCRIPTION	VOLTAGE	
Nominal Voltage:	±320 kV	
Ampacity:	3000A	(CMP Standard)
Connections (Compression / Bolted / Welded):	TBD	

5. Structures

Substation structural steel is to be designed in conformance with ASCE standards and per CMP Substation Standard Specification as listed. The design will consider shipping restrictions and minimize the need for special offloading equipment and provisions. Steel designs are to include all assembly hardware and anchoring systems (anchor bolts, rods, etc.) along with torque requirements.

6.0 FOUNDATIONS AND CONCRETE

6.1 Foundation Type & Application

Foundations will be designed to be in accordance with all relevant CMP design standards as listed. All station dead end foundations are primarily compression/uplift type foundations. The equipment support foundations are primarily laterally loaded (moment type) foundations. Slab type foundation will also be used as appropriate for equipment mounting.

6.2 Foundation Design Parameters

The foundation design shall consider the following soil properties for each soil layer

- Soil type
- Thickness of soil layer
- Soil density (unit weight)
- Soil friction angle
- Pressure meter Modulus
- Undrained shear strength
- Adhesion factor
- Cohesion
- Horizontal stress coefficient, k_0
- Depth to ground water (both at time of drilling and estimated high)

All foundations will be designed for a 6" minimum reveal above the top rock cover. All drilled pier foundations shall be designed according to the L-pile parameters provided in the geotechnical reports. The soil parameters provided are reduced to account for soil loosening resulting from frost dissipation to a depth of 6 feet. Due to the 72 inch frost depth all slab foundations will require soil correction in order to prevent frost heave. Soil correction will consist of either 6 ft. of non-frost susceptible fill, or 4" of foam insulation to be placed under the foundation. All CMP Standards listed shall apply, unless otherwise stated.

6.3 Concrete & Anchor Bolts

The concrete used in the foundations shall have a minimum 28-day compressive strength of 4,500 psi with a water to cement ratio not to exceed 0.45. Concrete placed under water shall have a minimum 28-day compressive strength of 5,000 psi. All concrete specifications, concrete design and reinforcing steel requirements shall be in accordance with the latest Minnesota adopted edition of the Building Code Requirements for Reinforced Concrete (ACI-318). All vertical reinforcing steel shall be ASTM A-615 Grade 60 and all lateral (hoops) reinforcing steel shall be ASTM A-615 Grade 60. A minimum of three inches (3 in.) of clear space is required from the outermost reinforcing steel to the side of the excavation. Cast in place anchor bolts shall be ASTM F1554 GR 36 or ASTM A615 Grade 75 deformed bars, threaded at the end(s). Epoxy anchor bolts shall be HILTI HIT HY200. (Refer to applicable CMP Standards)

7. Grounding

The substation grounding design shall provide a ground mat system consisting of main ground grid conductors, ground rods, grounding mats and structure ground stingers as necessary for a complete grounding installation. The substation grounding system for each installation will be designed to meet the recommendations defined in IEEE 80 and Owner design standards.

All equipment, cabinets, structures, fencing, gates are to be connected to the main ground grid. Below grade ground grid conductors shall be bonded at each joint and ground rod using either

exothermic connections or compression style connectors. Above grade connections to buildings, equipment, cabinets and structures shall use compression type connectors. Ground stinger connections shall be 4/0 minimum.

The grid design will be based on maximum available symmetrical fault current levels and a clearing time of 0.5 seconds. The acceptable limits for touch and step potential used in designing the grounding system shall be in accordance with IEEE 80. The grid design will be modeled in CDEGS. (Refer to applicable CMP Standards as listed)

7.1 Ground Grid Design Requirements

The substation ground grid shall meet the following minimum requirements: (Refer to applicable CMP Standards as listed)

- Main Ground grid will be made up of minimum 4/0 CU, 19 strand, soft drawn.
- Ground grid is to be buried eighteen inches (18 in.) below the top of sub grade (not including top rock)
- Ground grid will be installed three feet (3 ft.) outside the fence line perimeter.
- The ground grid must be extended at all entrance gates, so that the outermost ground conductor is always three feet (3 ft.) away from the extent of fence metalwork including gate swing areas.
- Ground rods shall be located and connected to the ground grid per design calculations.
- Ground rod length shall be determined by the ground grid design and geotechnical investigation.
- Dedicated ground rods are required at each set of surge arresters and at all shield wire attachment structures.
- Control building shall have two tinned or silver plated ground pads with NEMA 4-hole pads on opposite corners of the structure which are to be connected to the ground grid.
- Below grade copper mats shall be installed at each disconnect switch operator.
- A layer of minimum four inch (4 in.) deep crushed (not smooth rounded), washed rock, $\frac{3}{4}$ " to 1" grade, to be used throughout the substation area and up to five feet (5 ft.) beyond the fence boundary.
- Fence is to be connected to the main grid at all corners posts and every other line post. Fence is to be grounded using #4 CU, 7 strands, soft drawn.

8. Fencing

The substation yard will be secured with a chain link fence consisting of steel posts, a minimum of nine (9) feet of galvanized steel wire woven fabric in accordance with ASTM A392, Class 2 and at least three (3) strands of 12.5 USWG steel barbed wire in accordance with ASTM A121, Class 3. The gate and corner posts shall be imbedded six (6) feet into a concrete foundation. Line posts shall be direct driven. Gates shall be installed as required to allow ready access to qualified personnel and adequate turning radius for the equipment necessary to construct, maintain and operate the substation. The design and construction shall comply with MP and NESC requirements. Signage will be installed in accordance with NESC, ANSE Z535 and MP requirements. (Refer to applicable CMP Standards as listed)

8.1 Main Fence Type & Material

Fence Type (Type)	Chain Link
Fence Height	9 Ft (+1 ft barbed wire)
Fence Material (Type)	Galvanized Steel Fabric
Fence Foundation	Augured concrete Pier Perimeter Footing and direct driven
Drive Gates, Size, & Quantity	Two, 24'
Personnel Gates, Size, & Quantity	One, 4'

9. Low Voltage Cable (600V & Below)

All power and control cables (if required) shall be in accordance with CMP Standard Specifications Flame Retardant Power & Control Cable. (Refer to applicable CMP Standards as listed)

9.1 Control Cable

No active control cables are planned for this facility.

9.2 Fiber Optic ADSS/Dielectric Cable

All Fiber Optic Cables will be furnished and installed by other contractors and the specification requirements will be in other documents. (CMP Telecommunications Standards will be applied in this area)

10. CONDUIT & CABLE TRENCH REQUIREMENTS

10.1 Cable Trench

No cable trench is expected for the termination stations

10.2 Conduit System

A complete conduit system shall be provided to complete all routing needs for the cabling system. The minimum conduit size used in below grade applications shall be two inches (2 in). The minimum conduit size for above grade applications shall be one inch (1 in). Below grade conduits shall be PVC. Above grade conduits shall be Rigid Galvanized Steel (RGS) or Flexible Liquid Tight (Flex). Below grade elbows for risers shall be 90° RGS with a 24” minimum radius. All other below grade elbows shall be PVC with 24” minimum radius.

The conduits shall be installed with all appropriate hardware to meet NEC requirements and shall include lock nuts, joints/couplers, bell ends, watertight provisions, etc. as required to provide for a complete system. (Refer to applicable CMP Standards as listed)

10.3 Splice Vaults (Pull-through & other applications)

The cable and splice vaults will generally be part of the EHV cable installation contractors scope of work. It is envisioned that the vaults will be placed before major substation above grade work is completed. Salient features include:

- a. Splice Manhole Type (Precast or Cast in Place) Precast
- b. Splice Manhole Size (L' x W' x H' outside) TBD
- c. Number of Circuits per Manhole One pole or spare per manhole
- d. Number of Splicing Manholes 6 Pull-Through Vaults
- e. Minimum Cover 24”
- f. Number of Access Lids 2
- g. Vault Spacing TBD
- h. Vault Loading Requirements (H-20, as required determined by location)

11. Substation Lighting

No permanent active lighting systems are planned for these stations. Only temporary generator supplied portable lighting will be used during nighttime maintained operations.

12. Substation Lightning Protection

The substation shall be protected from lightning strokes to meet the Isokeraunic level. The stroke protection system shall consist of dead end structures, static masts, support hardware and shield wires directly connected to the ground grid. Shielding shall be based on the use of the rolling sphere analysis method per IEEE 998-2012, including failure probability as noted in Section 3 and Annex D. Shield wire routings shall be parallel to bus work whenever possible and routed to minimize main bus crossings.

Static wires shall be 7#7 Alumoweld steel electrically connected to the ground grid (either directly or via the terminating structure) on both ends of the static wire span. OPGW static wires will also be allowed for use as needed. All shield poles and dead ends used for shielding shall have a ground rod installed within three (3) feet of the structure with a minimum of two (2) separate connections between the structure the and the substation grounding. (Refer to applicable CMP Standards as listed)

13. Wind Loading Criteria

DESCRIPTION	MPH
Average Wind Speed: (Basic)	40
Highest Wind Maximum: (ASCE 7-16)	113
Gust Factor	TBD

14. Maximum icing (radial coating to assume)

DESCRIPTION	Inches Radial
Average	0.5
Highest Icing Maximum: (CMP Standard)	1.5
Highest Icing Maximum (ASCE 7-16)	1.0

15. Expected Lightning probabilities

TBD based on overall Transmission Line design parameters.

16. Pollution Levels (including dust borne caused)

Without any local condition information to fully determine the pollution including blowing dust at the two Termination Stations it has been assumed that the (per IEC 60815) that the following creepage lengths will be used:

Type of Insulation	Creepage Length
Porcelain Insulators/Bushings	50 mm/kV
Silicone Rubber Insulators/Bushings	40 mm/kV

17. Temperature extremes

DESCRIPTION	Temperature
Lowest (Centigrade)	-40° C
Highest Possible (Centigrade)	+40° C

18. Humidity Extremes

DESCRIPTION	
Average Low	61%
Highest Expected	82%
(needs further investigation at cable termination sites)	

19. Snowfall Maximum

DESCRIPTION	Inches/24 hours
Average	12
Highest Accumulation	40
(needs further investigation at the cable termination sites)	

20. Rainfall Maximum

DESCRIPTION	Inches/hr.
Average (15 minute Intensity)	4.39
Highest (60 minutes Intensity)	1.79

21. Seismic Levels (IEEE 693, most probably “low performance” in this location)

The local Seismic levels in accordance with USGS Mapping appear to be classified as an IEEE 693 “LOW PERFORMANCE” (for “Essential Facilities”). This level of seismic performance may be modified after detailed geotechnical investigations are completed.

Building Code Reference Document 2012/2015 International Building Code
(which utilizes USGS hazard data available in 2008)
Site Coordinates 45.34696°N, 69.95856°W
Site Soil Classification Site Class B - “Rock”
Risk Category IV (e.g. essential facilities)



USGS-Provided Output

$S_s = 0.202\text{ g}$ $S_{M1} = 0.202\text{ g}$ $S_{M2} = 0.134\text{ g}$
 $S_1 = 0.082\text{ g}$ $S_{M1} = 0.082\text{ g}$ $S_{M2} = 0.055\text{ g}$

For information on how the S_s and S_1 values above have been calculated from probabilistic (risk-targeted) and deterministic ground motions in the direction of maximum horizontal response, please return to the application and select the “2009 NEHRP” building code reference document.

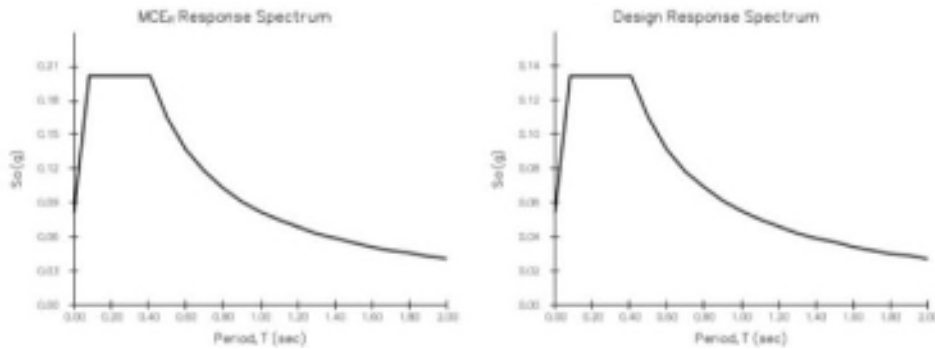

22. Oil containment (as pertaining to double wall alarmed oil storage tank system)

No active oil storage or containment systems are planned for these termination stations.

23. Station security video surveillance, and intrusion alarming

No active security measures are planned for these stations.

24. Telecommunications & Protection & Control Overview

No active telecommunications or protection equipment is planned for these stations. Passive cable fault locators will be utilized on each cable termination.

25. Prefabricated Substation Buildings (EEE) & Associated Auxiliary Power Systems

No Buildings are planned for this station development at this time.

Attachment V

MEMORANDUM OF UNDERSTANDING

This Memorandum of Understanding (“MOU”) dated May 30, 2018 is between CENTRAL MAINE POWER COMPANY (“CMP”), a Maine corporation, and WESTERN MOUNTAINS & RIVERS CORPORATION (“WM&RC”), a Maine nonprofit corporation.

BACKGROUND

- A. CMP has submitted a proposal in response to the Massachusetts 83D Clean Energy Request for Proposals (“RFP”) for transmission services in connection with the New England Clean Energy Connect generation and transmission project (the “Project”), and the Project has been conditionally selected under the RFP to proceed to contract negotiation and regulatory approvals.
 - B. The transmission line to be constructed as part of the Project is proposed to cross the Kennebec River in the area of the Kennebec Gorge, Somerset County, which crossing may be above-ground or underground.
 - C. WM&RC is a Maine nonprofit public benefit corporation formed for the purpose of expanding conservation of the Kennebec, Dead, Sandy, Moose, Sebasticook and Carrabassett rivers; developing recreation projects; developing education programs about the history, ecology and uses of Maine’s rivers; and expanding economic development opportunities along the rivers of Western Maine.
 - D. CMP and WM&RC wish to establish a framework to mitigate any environmental, natural resource and community impacts of the Project and to provide additional economic development opportunities to Somerset County.
1. Initial Support for WM&RC. As a demonstration of its good faith efforts to mitigate the environmental, natural resource and community impacts of the Project in Somerset County, within ten (10) days following the execution of this MOU, CMP will donate the amount of \$250,000 to WM&RC to support its charitable mission, including funding WM&RC’s initial start up expenses such as legal, accounting, consulting, staffing, travel and planning expenses.
 2. Additional Support for WM&RC. Subject to (a) the receipt of all permits, licenses and approvals required for the Project to be constructed and operated (“Required Approvals”); and (b) the execution and delivery by CMP, the generator participating in the Project, and the Massachusetts utilities sponsoring the RFP of the power purchase, transmission services and other agreements needed to move forward with the Project (the “Project Contracts”) and such permits, licenses and approvals have become final and not subject to appeal or rehearing (collectively, the “Preconditions”), CMP agrees to:

- (i) Consultation as to Project. To ensure that the Project does not unreasonably interfere with or adversely affect existing scenic, aesthetic, recreational, or navigational uses, consult with WM&RC on the design, construction, and ongoing maintenance plan for the portion of the Project in the vicinity of the Kennebec Gorge, including with respect to the location and design of the transmission lines crossing the Kennebec Gorge and the nearby structures, equipment requirements, construction timing, vegetation plans, and buffering of the transmission facilities crossing the Kennebec River Gorge from other uses and resources.
 - (ii) WM&RC Support Funding. Commencing on the first anniversary of the execution of this MOU by both parties, provide to WM&RC annual grants for five (5) years in the amount of \$50,000 each year to support WM&RC's charitable mission, including in particular, the promotion of outdoor activities in Central and Northern Somerset County and the improvement of the current trail and track network in the area.
- 3. CMP Land. Subject to the fulfillment of the Preconditions, CMP further agrees to (A) negotiate in good faith with any Central and Northern Somerset County business lawfully operating on land leased from CMP with respect to an option to purchase such land as well as adjacent land owned by CMP that is not essential to CMP's current or anticipated future needs and reasonably necessary for the expansion needs of such business, (B) consider in good faith making available land owned by CMP located in Central and Northern Somerset County and not essential to CMP's current or anticipated future needs for economic development, such as for an outfitting center, reservations center, public tourist services center, or a meeting space or classroom for local business and educational institutions, as part of broader discussions relating to economic development plans for the area among CMP, WM&RC and other interested parties, (C) make available to WM&RC access to gravel pits and use of gravel for development and maintenance of recreational assets at no fee to WM&RC, and (D) cooperate in good faith to facilitate access to the use of Project corridor for ATV, snowmobile and other recreational uses, consistent with applicable laws, regulations, ordinances, permits and licenses and CMP's generally applicable standards and practices. WM&RC shall be responsible for obtaining all permits required to remove or utilize such gravel and for all costs of obtaining any such permits and of removing or utilizing such gravel.
 - (i) Harris Station, Indian Pond & Carrybrook Public Access. To the extent permitted by FERC and Brookfield (where applicable), provide public and commercial access to Harris Station, Indian Pond & Carrybrook for whitewater rafting, boating, fishing, and snowmobile, ATV, bicycle and other motorized and non-

motorized trail uses through CMP's existing easement rights or through CMP's purchase of the Indian Pond Road from Moxie Lands LLC, and negotiate a no fee easement for commercial recreational access on Lower Enchanted Road.

- (ii) Optical Ground Cable. In the event that CMP constructs the Project, it will include an optical ground cable with multiple strands of fiber optic cable at CMP's sole expense, enabling expanded broadband, wide area Wi-Fi and other enhanced communication services for the residents and businesses of Somerset and Franklin counties through the ability to loop fiber on the Route 27 and 201 corridors.

4. Specific Project Mitigation and Community Benefits Commitments.

- (a) In the event that the Project is constructed such that it crosses Kennebec Gorge overhead, and subject to the Preconditions being met, CMP agrees to:

- (i) Design the portion of the Project that crosses Kennebec Gorge so as to minimize and mitigate, to the extent reasonably technically and commercially feasible, any visual impact thereof, such as by the placement of structures to eliminate or at least substantially reduce visibility of Project structures from the river user's perspective.

- (ii) In order to support economic development in Central and Northern Somerset County, evaluate and negotiate in good faith donations of CMP land that is not essential to CMP's current or anticipated future needs for trails, huts, Kennebec River leases and other recreational infrastructure or amenities benefitting the region, including as part of this evaluation the following:

- Old Rail Bed from Indian Pond to Route 15 in Rockwood
- River Frontage below The Forks
- 670 Acres on the Dead River below Grand Falls to be potentially made available to WM&RC or to one or more other charitable and/or environmental organizations designated by WM&RC
- Flagstaff Hut lease released
- Hut Sites leased at Grand Falls, Chase Stream and Indian Pond and trails under license agreement to Maine Huts & Trails
- Moxie Falls trail easements acquired and assured for 1 motorized and 1 non-motorized trail from town to the falls.
- Availability for single track bike trails off the existing and proposed bike trail system
- North End of Indian Pond

- Below the dam on the Kennebec River

It is intended that these land donations and acquisitions for trails would complete and connect The Forks Area trails system (formerly the FAST trail, Ridge Trail section) from the Flood Road to the center of town.

- (iii) Contribute in a lump sum to the trust described in Section 4(c) \$16,000,000 to support and enhance tourism and outdoor recreation in the Central and Northern Somerset County, including construction, operation and staffing of a visitor center, maintenance of trails, funding of education programs to improve the local tourism economy; WM&RC commits to leverage these grant funds to obtain funds from philanthropic donations, the local tourism bureau, local businesses and other sources to the maximum extent possible.
 - (iv) Contribute in a lump sum to the trust described in Section 4(c) \$6,000,000 to fund maintenance costs associated with the tourism infrastructure described in clause (iii) above and for continued funding of education and other programs to improve the local tourism.
- (b) In the event that the Project is constructed such that it (i) crosses the Kennebec Gorge underground, (ii) crosses overhead at Harris Dam, or (iii) completes the Project by any other overhead or underground crossing of the Kennebec or Dead rivers, and subject to the Preconditions being met, CMP agrees to contribute in a lump sum to the Trust described in Section 4(c) to support the programs described in clause (a)(iii) above of at least \$5,000,000, but in no case exceeding \$10,000,000.
- (c) CMP commits to create an irrevocable Maine charitable trust to hold the contributions described in Sections 4(a)(iii) and (iv) or 4(b) above, as applicable, (the "Contributions"). By good faith agreement of WM&RC and CMP, the Trust shall have three trustees, one of which shall be designated by WM&RC, one of which shall be designated by CMP, and one to be chosen by mutual agreement of WM&RC and CMP. With regard to the Contributions, upon request of WM&RC for a distribution from the trust, the Trustees shall distribute the requested funds unless a majority of the Trustees find that the intended use is clearly outside of the charitable mission of WM&RC. If WM&RC requests the distribution of funds to a governmental entity or other tax-exempt organization for purposes consistent with WM&RC's charitable mission, which will allow said distribution of funds to be leveraged for additional funds, public or private, the Trustees shall distribute the funds requested by WM&RC, subject to compliance with all applicable laws and regulations, unless a majority of the Trustees find that the intended use of such funds is clearly outside the charitable mission of

WM&RC. CMP and WM&RC further agree to cooperate in good faith to establish and memorialize the charitable trust described herein within sixty (60) days of execution of this MOU. Within ten (10) days of completion of the Project and satisfaction of the Preconditions, CMP shall make the Contribution(s) to the Trust provided under Sections 4(a)(iii)-(iv) or Section 4(b), as applicable.

5. Tax Exempt Organization Matters. WM&RC is in the process of applying for 501(c)(3) tax-exempt status as a publicly supported charitable organization. Until WM&RC is designated by the Internal Revenue Service as such 501(c)(3) tax exempt organization, the funds to be provided by CMP under this MOU will be delivered to the Somerset Economic Development Corporation (“SEDC”) in its capacity as fiscal sponsor for WM&RC. As a precondition to the delivery of any such funds to SEDC, WM&RC shall deliver to CMP a written acknowledgment executed by SEDC and reasonably satisfactory to CMP in which SEDC confirms its agreement to act as fiscal sponsor for WM&RC as provided herein (including an executed copy of such agreement) and to disburse the funds provided by CMP hereunder in accordance with WM&RC’s charitable mission, an executed copy of which SEDC acknowledges receiving and reviewing. In addition, such written acknowledgement shall also provide that SEDC will agree to confirm to CMP in writing its receipt of funds from CMP hereunder and to promptly notify CMP in writing of each disbursement by SEDC of funds provided hereunder by CMP to or at the direction of WM&RC. Following WM&RC’s receipt of its 501(c)(3) certification and the termination of SEDC’s role as fiscal agent, any and all funds provided by CMP hereunder (and interest and investment income thereon), (other than the funds to be contributed to the Trust described in Section 4(c)) shall be transferred to WM&RC.
6. Future Collaboration on Impact Mitigation Measures. In the event that CMP does not receive the Required Approvals for the Project, but CMP nonetheless elects to pursue the construction and operation of a transmission line that will cross the Kennebec River in the area of the Kennebec Gorge, Somerset County, which crossing may be above-ground or underground (an “Alternate Transmission Line”), CMP agrees to:
 - (a) Negotiate in good faith with WM&RC with respect to a memorandum of understanding specific to the Alternate Transmission Line relating to environmental and resource impact mitigation and regional economic development initiatives;
 - (b) Consider in good faith, following consultation with WM&RC, alternative locations for crossing the Kennebec River, including the utilization of existing corridors and crossing at or below Harris Dam;
 - (c) If applicable and appropriate, negotiate in good faith with other land and easement owners to secure the necessary land rights for alternative

transmission corridors without implicating significant changes to the existing Harris Dam FERC license (except for a line crossing at or below Harris Dam or widening existing corridors); and

- (d) Regularly update WM&RC on the status of the activities contemplated by clauses (b) and (c) hereof.

7. Agreements of WM&RC.

- (a) At the request of CMP, WM&RC will provide written and/or oral testimony to one or more regulatory agencies with the power to issue one or more of the Required Approvals. The essence and extent of WM&RC's testimony will be that the mitigation packages for the crossings described in Sections 4(a) and 4(b) of this MOU are appropriate offsets to the environmental, natural resource and community impacts of the Project because the benefits of the packages to the region are substantial and long lasting.
- (b) WM&RC will apply for 501(c)(3) status as soon as it is eligible to do so, will diligently pursue such status and will act in accordance with the requirements of the Internal Revenue Code, related regulations and applicable provisions of Maine law relating to such status.
- (c) WM&RC will file Articles of Amendment with Maine Secretary of State in the form attached hereto as Exhibit A.
- (d) WM&RC will amend its bylaws as set forth in the attached Exhibit B.
- (e) WM&RC will expend any funds provided to it by CMP under this MOU or by the Trust described in Section 4(c) in accordance with its charitable mission and in compliance with all applicable legal and regulatory requirements, including without limitation, the Maine Nonprofit Corporation Act, 13-B MRS § 101 et. seq., as amended, and Section 501(c)(3) of the Internal Revenue Code of 1986, as amended.

8. WM&RC Representations and Warranties. WM&RC represents and warrants as follows:

- (a) It has been duly incorporated and is in good standing as a Maine non-profit corporation;
- (b) The execution and delivery of this MOU by WM&RC and the performance by WM&RC of the obligations contained herein have been duly authorized by all necessary corporate action on the part of WM&RC, and do not conflict with or

violate any agreement to which WM&RC or any of its directors or officers is a party; and

- (c) The board of directors and officers of WM&RC are listed on Exhibit C attached hereto.

9. Miscellaneous.

- (a) This MOU shall be governed by Maine law.
- (b) Each party shall (i) comply with all applicable laws, regulations, codes and guidance relating to anti-bribery and anti-corruption, including without limitation the U.S. Foreign Corrupt Practices Act (the “Anti-Corruption Requirements”); and (ii) maintain and enforce adequate procedures and policies to comply with the Anti-Corruption Requirements.
- (c) This MOU shall be binding upon the parties’ respective successors and assigns. Neither party may assign this MOU without the written consent of the other party except as otherwise expressly allowed herein.
- (d) This MOU constitutes the entire agreement between CMP and WM&RC with respect to its subject matter and supersedes any and all prior oral or written agreements, expressions or understandings with respect to such subject matter. This MOU may be amended only by a written amendment executed by both parties.

IN WITNESS WHEREOF, the parties have caused this Memorandum of Understanding to be executed and delivered by their duly authorized representatives as of the date first written above.

CENTRAL MAINE POWER COMPANY

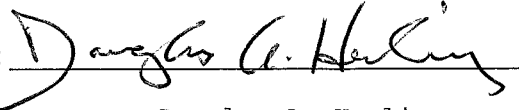
By: 

Name: Douglas A. Herling

Title: President & CEO

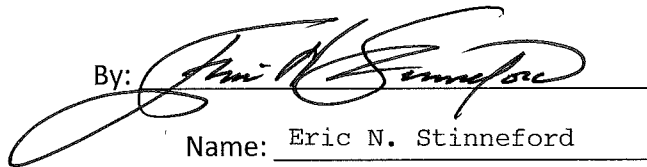
By: 

Name: Eric N. Stinneford

Title: V.P., Treasurer & Controller

WESTERN MOUNTAINS & RIVERS CORPORATION

By: _____

Name: _____

Title: _____

IN WITNESS WHEREOF, the parties have caused this Memorandum of Understanding to be executed and delivered by their duly authorized representatives as of the date first written above.

CENTRAL MAINE POWER COMPANY

By: _____

Name: _____

Title: _____

By: _____

Name: _____

Title: _____

WESTERN MOUNTAINS & RIVERS CORPORATION

By: Russell Walters

Name: RUSSELL WALTERS

Title: President

EXHIBIT A

Minimum Filing Fee \$10.00. An additional \$10 filing fee if changing the purpose

**DOMESTIC
NONPROFIT CORPORATION**

STATE OF MAINE

ARTICLES OF AMENDMENT

<p>_____ Deputy Secretary of State</p> <hr/> <p>A True Copy When Attested By Signature</p> <hr/> <p>_____ Deputy Secretary of State</p>
--

Western Mountains & Rivers Corporation
(Name of Corporation)

Pursuant to 13-B MRSA §§802 and 803, the undersigned corporation executes and delivers the following Articles of Amendment:

FIRST: ("X" one box only.) public benefit corporation mutual benefit corporation

SECOND: Describe **NATURE OF CHANGE** (i.e. change in name of corporation, purpose, number of directors, adding or deleting section or revision of section, etc.) as well as **TEXT** of amendment. Attach additional pages as needed.

Exhibit B referenced in Article Eighth of the Corporation's Articles of Incorporation is amended
in its entirety as set forth on the attached additional pages.

EXHIBIT A

THIRD: ("X" one box only.) The amendment was adopted on (date) _____ as follows:

- By the members at a meeting at which a quorum was present and the amendment received at least a majority of the votes which members were entitled to cast.
- (If the Articles require more than a majority vote.) By the members at a meeting at which the amendment received at least the percentage of votes required by the Articles of Incorporation.
- By the written consent of all members entitled to vote with respect thereto.
- (If no members, or none entitled to vote thereon.) By majority vote of the board of directors.

FOURTH: The address of the registered office of the corporation in the State of Maine is _____

1488 Middle Road, New Portland, ME 04961 - PO Box 92, Kingfield, ME 04947 (mailing)
(street, city, state and zip code)

DATED _____

*By _____
(signature)

Russell Walters, President

(type or print name and capacity)

*By _____
(signature)

(type or print name and capacity)

**MUST BE COMPLETED FOR VOTE
OF MEMBERS**

I certify that I have custody of the minutes showing the above action by the members.

(signature of clerk, secretary or asst. secretary)

*This document MUST be signed by any duly authorized officer. (13-B MRSA §104.1.B)

Please remit your payment made payable to the Maine Secretary of State.

SUBMIT COMPLETED FORMS TO: CORPORATE EXAMINING SECTION, SECRETARY OF STATE,
101 STATE HOUSE STATION, AUGUSTA, ME 04333-0101

Exhibit B to Articles of Incorporation
of
Western Mountains & Rivers Corporation

(a Maine Nonprofit Public Benefit Corporation)

Number of Directors. The number of Directors of the Corporation may be increased or decreased by a resolution of the Directors, provided that no decrease in number shall have the effect of shortening the term of any incumbent Director.

No Inurement. No part of the net earnings of the Corporation shall inure to the benefit of, or be distributable to its Directors, Officers, or other private persons, except that the Corporation shall be authorized and empowered to pay reasonable compensation for services rendered and to make payments and distributions in furtherance of the purposes set forth in Article Second hereof.

Dissolution; Distribution of Assets. Upon the dissolution of the Corporation, all of its assets remaining after payment of all of its liabilities shall be distributed to one or more nonprofit organizations engaged in activities in support of conservation, recreation and economic development opportunities in the State of Maine, or other activities substantially similar to those of the Corporation (within the meaning of 13-B M.R.S. § 407) and which may be selected by the Directors as an appropriate recipient of such assets, as long as such organization, or each of such organizations, shall then qualify as an organization exempt from federal income taxation under Section 501(c)(3) of the Code, Internal Revenue Code of 1986 as amended (the "Code"), or the corresponding section of any future federal tax code, and is classified as a public benefit corporation within the meaning of 13-B M.R.S. §1406.

Any such assets not so disposed of shall be disposed of by a Court of Competent Jurisdiction of the county in which the principal office of the Corporation is then located to such organization or organizations, as said Court shall determine, whose activities are substantially similar to those of the Corporation, as long as such organization, or each of such organizations, shall then qualify as an organization exempt from federal income taxation under Section 501(c)(3) of the Code, or the corresponding section of any future federal tax code, and is classified as a public benefit corporation within the meaning of 13-B M.R.S. §1406.

Tax Exempt Status. It is intended that the Corporation shall be entitled to exemption from federal income tax under Section 501(c)(3) of the Code. Notwithstanding any other provision of these Articles, the Corporation shall not engage in any activity or exercise any power which would deprive it of any exemption from federal income tax which the Corporation may receive under Section 501(c)(3) of the Code and contributions to which a deduction may be claimed under Sections 170(c)(2) and 2055(a)(2) of the Code.

No Discrimination. The Corporation shall be an equal opportunity employer, and shall not discriminate on the basis of age, race, religion, color, creed, sex, physical or mental

disability, sexual orientation or national origin: (i) in the persons served, or in the manner of service; (ii) in the hiring, assignment, promotion, salary determination, or other conditions of employment; or (iii) in the membership of the Board of Directors.

Amendment. Any amendment to these Articles of Incorporation shall be made by adoption of such amendment at a meeting of the Board of Directors upon receiving the favorable vote of three-quarters (3/4) of the Directors then in office; provided, however, that the Articles may not be amended in such a way as to cause the Corporation to lose its status (i) as a corporation which is exempt from federal income taxation as an organization described in Section 501(c)(3) of the Code, or (ii) as a corporation to which contributions are deductible under Sections 170(c)(2) and 2055(a)(2) of the Code, and provided, further, that Exhibit A to these Articles of Incorporation may not be amended without providing notice to the Maine Attorney General pursuant to 13-B M.R.S. §802(5).

EXHIBIT B

BYLAWS OF

Western Mountains & Rivers Corporation

Adopted: August 8, 2017

Revised: _____, 2018

ARTICLE I
GENERAL

Section 1.1. Name. The name of this Corporation shall be as set forth in the Articles of Incorporation as the same may be amended from time to time.

Section 1.2. Registered Agent. The Registered Agent of the Corporation shall be the person designated in the Articles of Incorporation, provided that the directors shall have the power to change the identity of the registered agent from time to time through an appropriate filing with the Maine Secretary of State.

ARTICLE II
PURPOSES

Section 2.1. General Purposes. The purposes of this Corporation shall be as set forth in the Articles of Incorporation as the same may be amended from time to time.

Section 2.2. Powers. This Corporation shall have all such powers as are authorized under Maine law, including without limitation the Maine Nonprofit Corporation Act, 13-B MRSA §101 and following (the “Act”), or as otherwise limited by the Board of Directors.

Section 2.3. Prohibition of the Inurement of Assets and Income to Private Persons. All the assets and income of the Corporation shall be used exclusively for its charitable, scientific, and educational purposes, and no part thereof shall inure to the benefit of any private individual; provided, however, that nothing contained herein shall be construed to prevent the payment by the Corporation of reasonable compensation for services rendered and to make payments and distributions in furtherance of the purposes set forth in the Articles of Incorporation.

Section 2.4. Dissolution. If this Corporation is dissolved or its legal existence terminated, either voluntarily or involuntarily, or upon final liquidation of the Corporation, none of its assets shall inure to the benefit of any private individual, and all of its assets remaining after payment of all of its liabilities shall be distributed to one or more organizations which the Board of Directors then determines is qualified both as an exempt organization under Section 501(c)(3) of the Internal Revenue Code, and as a public benefit corporation engaged in activities substantially similar to those of this Corporation (within the meaning of Section 407 of the Act).

Section 2.5. Tax Exempt Status. It is intended that the Corporation shall have and continue to have the status of a corporation which is exempt from federal income tax under Section 501(a) of the Internal Revenue Code of 1986, as amended, or successor provisions of

EXHIBIT B

federal tax law (the “Code”) as an organization described in Section 501(c)(3) of such Code, and to which contributions are deductible under Section 170(c)(2) and 2055(a)(2) of the Code which is other than a private foundation as defined in Section 509(a) of the Code. The Articles of Incorporation and these Bylaws shall be construed accordingly and all powers and activities shall be limited accordingly. No substantial part of the activities of the Corporation shall be the carrying on of propaganda, or otherwise attempting to influence legislation provided that the Corporation shall have the power to make an election under Section 501(h) of the Code. Likewise, the Corporation shall not participate or intervene in any manner or to any extent in any political campaign on behalf of any candidate for public office. Furthermore, the Corporation shall not engage in any activities that are unlawful under applicable federal, state or local laws, including, but not limited to, activities prohibited for an exempt organization under Section 501(c)(3) of the Code and regulations thereunder as they now exist or as they may hereafter be amended.

ARTICLE III MEMBERSHIP

Section 3.1. No Members. The Corporation shall have no members.

ARTICLE IV BOARD OF DIRECTORS

~~Section 4.1. Management by Board. The affairs of the Corporation shall be managed by its Board of Directors, which may exercise all powers of the Corporation and do all lawful acts and things necessary or appropriate to carry out the purposes of the Corporation.~~Management by Board; Powers and Duties. The affairs of the Corporation shall be managed by its Board of Directors. The Board of Directors shall have all powers and duties necessary, appropriate, or convenient for the administration of the affairs of the Corporation and for the management and operation of the Corporations property and activities, and may do and perform all acts and things not prohibited by law, the Articles of Incorporation, or these Bylaws. These powers and duties shall include, but not be limited to: (i) establishing and reviewing board policies governing the Corporation and its operations; (ii) ensuring adequate resources for the operation of the Corporation; (iii) identifying, cultivating, soliciting and acknowledging donors; (iv) establishing and supervising adequate accounting and financial procedures; and (v) promoting the goals and purposes of the Corporation and evaluating the Corporation against such goals and purposes. Notwithstanding anything in these Bylaws to the contrary, the Board of Directors is not empowered to perform any activity on behalf of the Corporation not permitted to be carried on by an organization exempt from federal income taxation under Section 501(c)(3) of the Code.

Section 4.2. Number of Directors; Eligibility. The number of Directors shall not be less than three (3) or more than twenty-five (25) and shall be fixed by the Board of Directors within the range set forth in the Articles of Incorporation, provided that no diminution in the number of Directors shall serve to reduce an incumbent Director’s term. Each Director shall be selected for his or her ability to participate effectively in fulfillment of the responsibilities of the Board. In addition, a director must demonstrate an interest in the purposes and activities of the Corporation and must be interested in donating his or her time, advice, skill, energy, and support in

EXHIBIT B

furtherance of the Corporation and its purposes and activities. Directors need not be residents of the State of Maine. Any individual is eligible for election to the Board; provided, however, that no more than forty-nine percent (49%) of the Directors may be “financially interested persons,” as hereinafter defined. “Financially interested persons” shall mean any individual who (i) has received compensation from the Corporation for personal services rendered to the Corporation by that individual within the previous twelve (12) months, whether as a full-time or part-time employee, independent contractor, consultant or otherwise, excluding any reasonable payments made to Directors for serving as directors, (ii) is entitled to receive a portion of the net income of a corporate or other business entity that provides, for compensation, personal services to the Corporation, or (iii) is the spouse, brother, sister, parent or child of any such individual. In the process of selection of individual candidates as Directors, consideration should be given to those individuals with skills, experience, interests, and expertise in areas of value to the Corporation.

Section 4.3. Election and Term of Office. The number of Directors to serve as the initial Board of Directors of the Corporation shall be four (4), to serve until the first Annual Meeting of the Board. Thereafter, the Directors shall be elected by the Board of Directors at its Annual Meeting. At the first Annual Meeting of the Board, the Directors will be elected to staggered terms so that, as nearly as possible, one third of the Directors will be elected for a one (1) year term, one third will be elected for a two (2) year term, and one third will be elected for a three (3) year term. Such terms will be assigned to the Directors by random drawing or similar means. Thereafter, each Director shall be elected to serve for a three (3) year term of office unless he or she sooner resigns or is removed.

Section 4.4. Vacancies. Any vacancy occurring on the Board of Directors may be filled by the affirmative vote of a majority of the remaining Directors. A person appointed to fill a vacancy shall serve until expiration of the term that would have been served had the vacancy not occurred.

Section 4.5. Removal of Directors. The Board of Directors may suspend or remove a Director at any time, with or without cause by a two-thirds (2/3) affirmative vote of the Directors then in office.

Section 4.6. Resignation. Any Director may resign at any time by giving written notice to the President of the Corporation. Such resignation shall take effect on the date of receipt or at any later time specified in such notice.

Section 4.7. Absences. If a Director misses three (3) consecutive meetings without excuse, such absences shall be deemed to constitute such Director’s tender of his or her resignation from the Board of Directors; provided, however, the Board of Directors shall have the authority to accept or reject such resignation.

Section 4.8. Compensation. Directors as such shall not receive any stated salaries for their services, but by resolution of the Board of Directors, the expense of attendance, if any, may be allowed for attendance at any meeting of the Board; but nothing herein shall be construed to preclude any Director from serving the Corporation in any other capacity and receiving compensation therefor.

EXHIBIT B

Section 4.89. Loans to Directors and Officers Prohibited. The Corporation shall make no loans to any Director or Officer.

ARTICLE V MEETING

Section 5.1. Annual Meeting. The Board of Directors shall meet annually (the “Annual Meeting”) for the purpose of electing the Directors and Officers then standing for election or reelection as the case may be, and for the transaction of such other business as may come before the meeting. The Annual Meeting shall be held during the month of June at such time and place as shall be designated by the Board of Directors. If for any reason the Annual Meeting is not held on the date specified herein, a substitute annual meeting may be held at any time following such date in lieu thereof, and any business transacted or elections held at such substitute annual meeting shall be as valid as if transacted or held at the Annual Meeting. A substitute annual meeting may be called in the same manner and by the person or persons authorized to call special meetings of the Directors.

Section 5.2. Regular Meetings. Regular meetings of the Board of Directors may be held at such time and at such place as may from time to time be determined by the Board of Directors.

Section 5.3. Special Meetings of Directors. Special Meetings of the Board of Directors may be called by the President of the Corporation on his or her own motion or upon written request of a majority of the Directors, and held not less than three (3) nor more than twenty-eight (28) days after such notice is given to each Director.

Section 5.4. Waiver. Whenever under the provisions of any statute, the Articles of Incorporation or these Bylaws notice is required to be given to any Director, a waiver thereof in writing, signed by the person or persons entitled to such notice, whether before or after the time stated therein, shall be deemed equivalent to the giving of such notice. Attendance of a Director at any meeting shall constitute a waiver of notice of such meeting, except where a Director attends for the express purpose of objecting to the transaction of any business because the meeting is not lawfully called or convened. Neither the business to be transacted at, nor the purpose of, any meeting of the Board of Directors need be specified in the notice or waiver of notice of such meeting unless required by law or these Bylaws.

Section 5.5. Directors’ Participation by Telephone. The Board of Directors or any committee of the Board of Directors may hold a meeting by conference telephone or similar communications equipment by means of which all persons participating in the meeting can hear each other, and such participation in a meeting shall constitute presence of the Director or committee member at such meeting. Notice of such meeting shall give each Director or committee member the telephone number at which, or other manner in which, he or she may participate in the meeting.

EXHIBIT B

Section 5.6. Manner of Acting. Except as specified by law or these Bylaws, the Board of Directors shall act by a majority vote of the Directors present at any duly called and noticed meeting at which a quorum is present. Each Director shall have one (1) vote.

Section 5.7. Quorum; Adjournment. A majority of the Directors then in office shall constitute a quorum for the transaction of business.

Section 5.8. Conduct of Meeting; Record of Meetings. The President of the Corporation, or in his or her absence, the Treasurer, or in his or her absence, any Director chosen by the Directors present, shall call meetings of the Board of Directors to order and shall act as the presiding officer for the meeting. The Secretary, or if he or she does not participate in the meeting, one of the Directors designated by the Board participating in the meeting, shall keep a record of the meeting.

Section 5.9. Board Action by Unanimous Consent. Any action required or permitted to be taken at a meeting of the Directors may be taken without a meeting if each Director consents to such action described in writing setting forth the action so taken, signed by all of the Directors, and filed with the minutes of the meetings of the Board of Directors.

Section 5.10. Informal Action by Directors. Action of the Directors may be taken in accordance with the provisions of Section 708 of the Act. In amplification of, and not in limitation of the foregoing, action taken by agreement of a majority of Directors shall be deemed action of the Board of Directors if all Directors know of the action taken and no Director makes prompt objection to such action. Objection by a Director shall be effective if written objection to any specific action so taken is filed with the Secretary of this Corporation within twenty-one (21) days of such specific action.

Section 5.11. Notice. Whenever under the provisions of any statute, the Articles of Incorporation or these Bylaws notice is required to be given to any Director, such notice must be given in writing by personal delivery, electronic mail, U.S. mail, reputable commercial mail carrier, or telephone, at the address, email address, or phone number last supplied to the Corporation by such Director, with postage or other delivery fees prepaid. Notice by regular mail shall be deemed to be given at the time it is deposited in any facility of the United States Postal Service.

ARTICLE VI OFFICERS AND AGENTS

Section 6.1. Officers. The Officers of the Corporation shall be a President, a Treasurer, a Secretary, and such other officers as the Board of Directors may from time to time designate. The initial Officers of the Corporation shall be elected by the Board of Directors at the first meeting of the Board of Directors. Thereafter, the Officers of the Corporation shall be elected by the Board of Directors at each Annual Meeting, after the election of Directors.

Section 6.2. Other Officers and Agents. The Board of Directors may appoint additional officers and agents, as it shall deem necessary. Such officers and agents shall hold their offices

EXHIBIT B

for such terms and shall exercise such powers and perform such duties as shall be determined from time to time by the Board of Directors.

Section 6.3. Compensation. The compensation, if any, of the Officers and any additional officers and agents of the Corporation shall be fixed by the Board of Directors.

Section 6.4. Term and Removal of Officers. Each Officer shall hold office for a term of one (1) year or until his or her successor has been duly nominated and elected, but this provision shall not be construed as prohibiting an individual from holding an office for two (2) or more consecutive terms. The term of each Officer shall commence upon election. Any Officer may be removed with or without cause at any time by an affirmative vote of a majority of the Directors at a duly called and noticed meeting of the Board of Directors at which a quorum is present, or in accordance with Section 5.9 of these Bylaws. Any vacancy occurring in any office of the Corporation shall be filled by vote of the Directors.

Section 6.5. President of the Corporation. The President of the Corporation shall, when present, chair all meetings of the Board of Directors. He or she shall inform himself or herself concerning all affairs of the Corporation and see that the duties of the Officers and employees are properly discharged, that the Bylaws of the Corporation are observed, that all statements and returns required by law are made, and he or she shall assume such share in the management of the Corporation's business as the Directors may determine. The President shall perform all duties incident to the office of the President.

Section 6.6. Treasurer. The Treasurer shall have charge and custody of and be responsible for all corporate funds and securities, keep full and accurate accounts of receipts and disbursements and books belonging to the Corporation, and deposit all monies and other valuable effects in the name and to the credit of the Corporation in such depositories as may be designated by the Board of Directors. He or she shall disburse the funds of the Corporation as may be ordered by the Board of Directors, taking proper vouchers for such disbursements, and shall render to the President and the Board of Directors at its regular meetings or when the Directors shall require, an account of his or her transactions as Treasurer and of the financial condition of the Corporation. The Treasurer shall provide a bond in such sum and with such surety or sureties as the Board of Directors shall determine; and in general perform all the duties incident to the office of Treasurer and such other duties as from time to time may be assigned to him or her.

Section 6.7. Secretary. The Secretary shall keep written records of all meetings of the Corporation and the Board of Directors. The Secretary shall be responsible for keeping all additional documentation necessary for the administration and management of the Corporation and shall be responsible for providing required notice of meetings to the Directors. The Secretary shall provide all written records of the Corporation to his or her successor.

ARTICLE VII COMMITTEES

Section 7.1. Committees. The Board of Directors may establish an Executive, Governance, Finance, Program and other committees and may delegate, to the extent permitted

EXHIBIT B

by law, to such committee or committees all the authority of the Board of Directors, or any such portion of authority, as it deems appropriate to assist in the management of the Corporation.

Section 7.2. Composition. The Board of Directors shall appoint the members of each committee. Each committee shall consist of at least ~~one (1) Director~~ three (3) Directors, one of whom shall be appointed by the President to serve as the Chairperson of such committee.

ARTICLE VIII FINANCES

Section 8.1. Checks. All checks or demands for money and notes of the Corporation shall be signed by the Treasurer or Secretary and such other officers or persons as the Board of Directors may from time to time designate.

Section 8.2. Financial Commitments. No person shall financially commit the Corporation without the express authorization of the Board of Directors.

Section 8.3. Fiscal Year. The fiscal year of the Corporation shall end on June 30 unless otherwise fixed by resolution of the Board of Directors.

ARTICLE IX LIABILITY; INDEMNIFICATION

Section 9.1. Indemnification. The Corporation shall in all cases, to the fullest extent permitted by the Act, indemnify any person who was or is involved in any manner (including, without limitation, as a party or a witness) in any threatened, pending or completed investigation, claim, action, suit, or proceeding, whether civil, criminal, administrative, or investigative (including, without limitation, any action, suit, or proceeding brought by or in the right of the Corporation to procure a judgment in its favor) by reason of the fact that that person is or was a Director or Officer of the Corporation, against all liabilities and expenses actually and reasonably incurred by the person in connection with such actions, suits or proceedings including but not limited to attorneys' fees, judgments, fines and amounts paid in settlement. This Section is subject to the limitations set forth in Section 9.2.

Section 9.2. Limitations on Indemnification. No indemnification shall be provided for any person with respect to any matter as to which that person shall have been finally adjudicated in any action, suit or proceeding not to have acted in good faith in the reasonable belief that that person's action was in the best interests of the Corporation or, with respect to any criminal action or proceeding, had reasonable cause to believe that that person's conduct was unlawful. The termination of any action, suit or proceeding by judgment, order or conviction adverse to such person, or by settlement or plea of *nolo contendere* or its equivalent, shall not of itself create a presumption that such person did not act in good faith in the reasonable belief that his action was in the best interests of the Corporation, and, with respect to any criminal action or proceeding, had reasonable cause to believe that his conduct was unlawful.

EXHIBIT B

Section 9.3. Requirement of Indemnification. Any provision of Sections 9.1, 9.2 or 9.4 to the contrary notwithstanding, to the extent that a Director or Officer has been successful on the merits or otherwise in defense of any action, suit or proceeding referred to in Section 9.1, or in defense of any claim, issue or matter therein, that person shall be indemnified against all expenses and liabilities, including attorneys' fees, actually and reasonably incurred by that person in connection therewith. The right to indemnification granted by this Section 9.3 may be enforced by a separate action against the Corporation, if an order for indemnification is not entered by a court in the action, suit or proceeding wherein that person was successful on the merits or otherwise.

Section 9.4. Procedure. Any indemnification under Section 9.1, unless ordered by a court, shall be made by the Corporation only as authorized in the specific case upon a determination that indemnification of the Director or Officer is proper in the circumstances because that person has met the applicable standard of conduct set forth in Sections 9.1 and 9.2. That determination shall be made by the Board of Directors by a majority vote of a quorum consisting of Directors who were not parties to such action, suit or proceeding, or if such a quorum is not obtainable, or even if obtainable, if a quorum of disinterested Directors so directs, by independent legal counsel in a written opinion. Such a determination, once made by the Board of Directors, may not be revoked by the Board of Directors and upon the making of such determination by the Board of Directors, the Director or Officer may enforce the indemnification against the Corporation by a separate action notwithstanding any attempted or actual subsequent action by the Board of Directors.

Section 9.5. Expenses. Expenses incurred in defending a civil, criminal, administrative or investigative action, suit or proceeding may be authorized and paid by the Corporation in advance of the final disposition of that action, suit or proceeding upon a determination made in accordance with the procedure established in Section 9.4 that, based solely on the facts then known to those making the determination and without further investigation, the person seeking indemnification satisfied the standard of conduct prescribed by Sections 9.1 and 9.2. Those persons making such determination may, in their discretion, require such person to provide the following to the Corporation:

- (a) A written undertaking by or on behalf of the Officer or Director to repay that amount if that person is finally adjudicated:
 - (i) Not to have acted honestly or in the reasonable belief that the person's action was in or not opposed to the best interests of the Corporation;
 - (ii) With respect to any criminal action or proceeding, to have had reasonable cause to believe that the person's conduct was unlawful; and
- (b) A written affirmation by the Officer or Director that the person has met the standard of conduct necessary for indemnification by the Corporation as authorized in this section.

EXHIBIT B

The undertaking required by Paragraph (a) shall be an unlimited general obligation of the person seeking the advance, but need not be secured and may be accepted without reference to financial ability to make the repayment.

Section 9.6. Enforceability. The indemnification and entitlement to advances of expenses provided by this Article shall not be deemed exclusive of any other rights to which those indemnified may be entitled under any bylaw, agreement, vote of disinterested Directors or otherwise, both as to action in that person's official capacity and as to action in another capacity while holding such office, and shall continue as to a person who has ceased to be a Director or Officer and shall inure to the benefit of the heirs, executors and administrators of such a person. A right to indemnification may be enforced by a separate action against the Corporation, if an order for indemnification has not been entered by a court in any action, suit or proceeding in respect to which indemnification is sought.

Section 9.7. Insurance. The Corporation shall have the power to purchase and maintain insurance on behalf of any person who is or was a Director or Officer against any liability asserted against that person and incurred by that person in any such capacity, or arising out of that person's status as such, whether or not the Corporation would have the power to indemnify that person against such liability under this Article.

ARTICLE X CONFLICTS OF INTEREST

Section 10.1. General. In the exercise of its powers under the provisions of any statute, the Articles of Incorporation, or these Bylaws, the Corporation and its Directors and Officers shall act in accordance with the Conflict of Interest Policy appended hereto as Exhibit A.

ARTICLE XI AMENDMENTS

Section 11.1. General. These Bylaws may be amended or repealed or new Bylaws adopted by a two-thirds (2/3) vote of the Directors then in office.

ARTICLE XII EFFECTIVE DATE

Section 12.1. General. These Bylaws shall take effect from the time of their adoption.

EXHIBIT B

EXHIBIT A TO BYLAWS OF

Western Mountains & Rivers Corporation

CONFLICT OF INTEREST POLICY

Article I

Purpose

1.1 Purpose. The purpose of this Conflict of Interest Policy (this “Policy”) is to protect the interests of this tax-exempt organization (the “Corporation”) when it is contemplating entering into a transaction or arrangement that might benefit the private interest of an Officer or Director of the Corporation or might result in a possible excess benefit transaction. This Policy is intended to supplement but not replace any applicable federal laws or laws of the State of Maine governing conflict of interest applicable to nonprofit and charitable organizations.

Article II

Definitions

2.1 Interested Person. Any Director, Officer, or member of a committee with powers delegated by the Board of Directors, who has a direct or indirect financial interest, as defined below, is an “Interested Person.”

2.2 Financial Interest. A person has a “Financial Interest” if the person has, directly or indirectly, through business, investment, or family:

- (a) An ownership or investment interest in any entity with which the Corporation has a transaction or arrangement;
- (b) A compensation arrangement with the Corporation or with any entity or individual with which the Corporation has a transaction or arrangement; or
- (c) A potential ownership or investment interest in, or compensation arrangement with, any entity or individual with which the Corporation is negotiating a transaction or arrangement.

Compensation includes direct and indirect remuneration as well as gifts or favors that are not insubstantial.

A Financial Interest is not necessarily a conflict of interest. Under Article III, Section 3.2 of this Policy, a person who has a Financial Interest may have a conflict of interest only if the appropriate governing board or committee decides that a conflict of interest exists.

EXHIBIT B

Article III Procedures

3.1 Duty to Disclose. In connection with any actual or possible conflict of interest, an Interested Person must disclose the existence of the Financial Interest and be given the opportunity to disclose all material facts to the Directors and members of committees with powers delegated by the Board of Directors considering the proposed transaction or arrangement.

3.2 Determining Whether a Conflict of Interest Exists. After disclosure of the Financial Interest and all material facts, and after any discussion with the Interested Person, the Interested Person shall leave the Board of Directors or committee meeting while the determination of a conflict of interest is discussed and voted upon. The remaining Directors or committee members shall decide if a conflict of interest exists.

3.3 Procedures for Addressing the Conflict of Interest.

- (a) An Interested Person may make a presentation at the Board of Directors or committee meeting, but after the presentation, the Interested Person shall leave the meeting during the discussion of, and the vote on, the transaction or arrangement involving the possible conflict of interest.
- (b) The chairperson of the Board of Directors or committee shall, if appropriate, appoint a disinterested person or committee to investigate alternatives to the proposed transaction or arrangement.
- (c) After exercising due diligence, the Board of Directors or committee shall determine whether the Corporation can obtain with reasonable efforts a more advantageous transaction or arrangement from a person or entity that would not give rise to a conflict of interest.
- (d) If a more advantageous transaction or arrangement is not reasonably possible under circumstances not producing a conflict of interest, the Board of Directors or committee shall determine by a majority vote of the disinterested Directors whether the transaction or arrangement is in the Corporation's best interest, for its own benefit, and whether it is fair and reasonable. In conformity with the above determination it shall make its decision as to whether to enter into the transaction or arrangement.

3.4 Violations of the Conflicts of Interest Policy.

- (a) If the Board of Directors or committee has reasonable cause to believe a member has failed to disclose actual or possible conflicts of interest, it shall inform the member of the basis for such belief and afford the member an opportunity to explain the alleged failure to disclose.
- (b) If, after hearing the member's response and after making further investigation as warranted by the circumstances, the Board of Directors or committee determines the

EXHIBIT B

member has failed to disclose an actual or possible conflict of interest, it shall take appropriate disciplinary and corrective action.

Article IV Records of Proceedings

4.1 Minutes. The minutes of the Board of Directors and all committees with powers delegated by the Board of Directors shall contain:

- (a) The names of the persons who disclosed or otherwise were found to have a Financial Interest in connection with an actual or possible conflict of interest, the nature of the Financial Interest, any action taken to determine whether a conflict of interest was present, and the Board of Director's or committee's decision as to whether a conflict of interest in fact existed.
- (b) The names of the persons who were present for discussion and votes relating to the transaction or arrangement, the content of the discussion, including any alternatives to the proposed transaction or arrangement, and a record of any votes taken in connection with the proceedings.

Article V Compensation

5.1 Recusal of Directors Required. A Director who receives compensation, directly or indirectly, from the Corporation for services is precluded from voting on matters pertaining to that Director's compensation.

5.2 Recusal of Certain Committee Members Required. A voting member of any committee whose jurisdiction includes compensation matters and who receives compensation, directly or indirectly, from the Corporation for services is precluded from voting on matters pertaining to that member's compensation.

5.3 Information May Be Presented. No voting member of the Board of Directors or any committee whose jurisdiction includes compensation matters and who receives compensation, directly or indirectly, from the Corporation, either individually or collectively, is prohibited from providing information to any committee regarding compensation.

Article VI Annual Statements

6.1 Signed Statements Required. Each Director, Officer and member of a committee with powers delegated by the Board of Directors shall annually sign a statement which affirms such person:

- (a) Has received a copy of this Policy;

EXHIBIT B

- (b) Has read and understands this Policy;
- (c) Has agreed to comply with this Policy; and
- (d) Understands the Corporation is charitable and, in order to maintain its federal tax exemption, it must engage primarily in activities which accomplish one or more of its tax-exempt purposes.

Article VII Periodic Reviews

7.1 Review Procedure. To ensure the Corporation operates in a manner consistent with charitable purposes and does not engage in activities that could jeopardize its tax-exempt status, periodic reviews shall be conducted. The periodic reviews shall, at a minimum, include the following subjects:

- (a) Whether compensation arrangements and benefits are reasonable, based on competent survey information, and the result of arm's length bargaining.
- (b) Whether partnerships, joint ventures, and arrangements with management organizations conform to the Corporation's written policies, are properly recorded, reflect reasonable investment or payments for goods and services, further charitable purposes and do not result in inurement, impermissible private benefit or in an excess benefit transaction.

Article VIII Use of Outside Experts

8.1 Use of Outside Experts. When conducting the periodic reviews as provided for in Article VII, Section 7.1 of this Policy, the Corporation may, but need not, use outside advisors. If outside experts are used, their use shall not relieve the Board of Directors of its responsibility for ensuring periodic reviews are conducted.

EXHIBIT C

List of WM&RC Directors and Officers

A. Directors

Name	Address
------	---------

Russell Walters

Larry Warren

Suzanne Hockmeyer

Joseph Christopher

John Philbrick

Heather Johnson

Peter Mills

Lloyd Trafton

B. Officers

<u>Name</u>	<u>Position</u>
Russell Walters	President
John Philbrick	Treasurer
Suzanne Hockmeyer	Secretary
Larry Warren	Registered Agent

Attachment VI

Proposal for Additional Mitigation, Kennebec River Crossing, NECEC

Conceptual Elements

May 31, 2018

CMP has designed the portion of the NECEC Project that crosses the Kennebec River so as to minimize and mitigate, to the extent reasonably technically and commercially practical, the visual impact thereof, such as by the placement of structures to eliminate or at least substantially reduce visibility of Project structures from the river user's perspective. Nonetheless, to mitigate any visual, environmental, natural resource, and community impacts of the NECEC's overhead crossing of the Kennebec River, and provide offsets to correct existing visual problems identified within the Kennebec River viewshed, CMP also will provide funding and land donations to support recreation and conservation in Somerset County, as follows:

1. Outdoor Recreation Funding. CMP will provide donations totaling in excess of \$22 million to support and enhance outdoor recreation in central and northern Somerset County, including for construction, operation, and staffing of a visitor center, further development of trails and tracks, maintenance of trails and tracks, and funding of education and cultural programs. In addition, CMP will provide annual grants for 5 years in the amount of \$50,000 each year to promote outdoor activities in central and northern Somerset County, and improve the current trail and track network in the area.
2. Gravel Pits. CMP will make available to a local recreational entity, at no cost, access to gravel pits owned or controlled by CMP, and use of gravel for development and maintenance of recreational assets.
3. Harris Station, Indian Pond, and Carrybrook Public Access. Consistent with the terms of existing easement rights, CMP will provide public and commercial access to Harris Station, Indian Pond, and Carrybrook for whitewater rafting, boating, fishing, snowmobile, ATV, bicycle, and other motorized and non-motorized trail uses through CMP's existing easement rights.
4. Donations of CMP Land. CMP will donate CMP land that is not essential to CMP's current or anticipated future needs for trails, huts, Kennebec River leases, and other recreational infrastructure or amenities benefitting the region, including some or all of the following:
 - Old rail bed from Indian Pond to Route 15 in Rockwood;
 - River frontage below The Forks;
 - Flagstaff hut lease released;

- Hut sites leased at Grand Falls and Indian Pond and trails under license agreement to Maine Huts & Trails;
- Moxie Falls trail easements acquired and assured for 1 motorized and 1 non-motorized trail from town to the falls; and
- Availability for single track bike trails off the existing and proposed bike trail system.

The land donations and acquisitions for trails will complete and connect The Forks Area trails system (formerly the FAST trail, Ridge Trail section) from the Flood Road to the center of town.

Attachment VIII

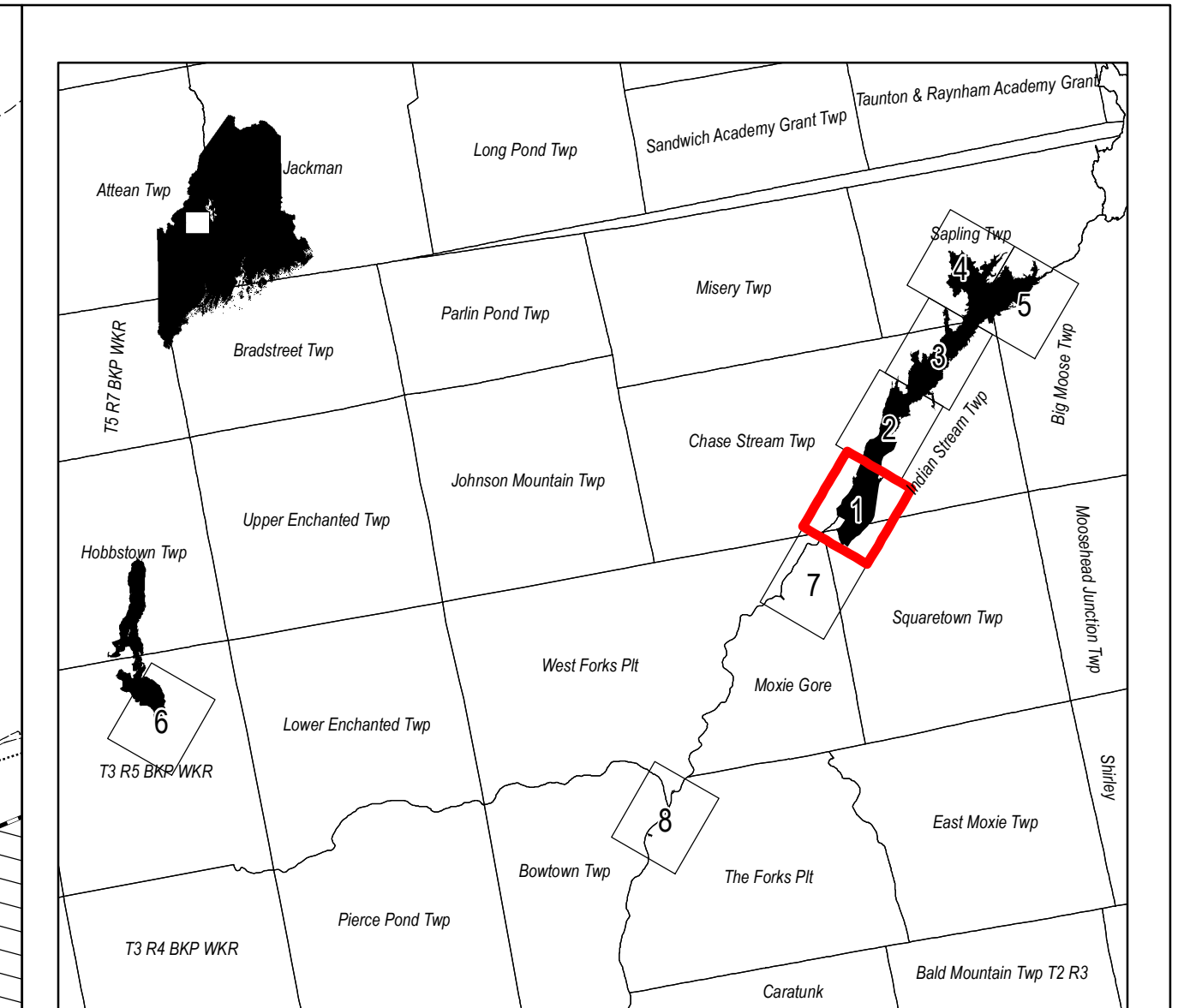
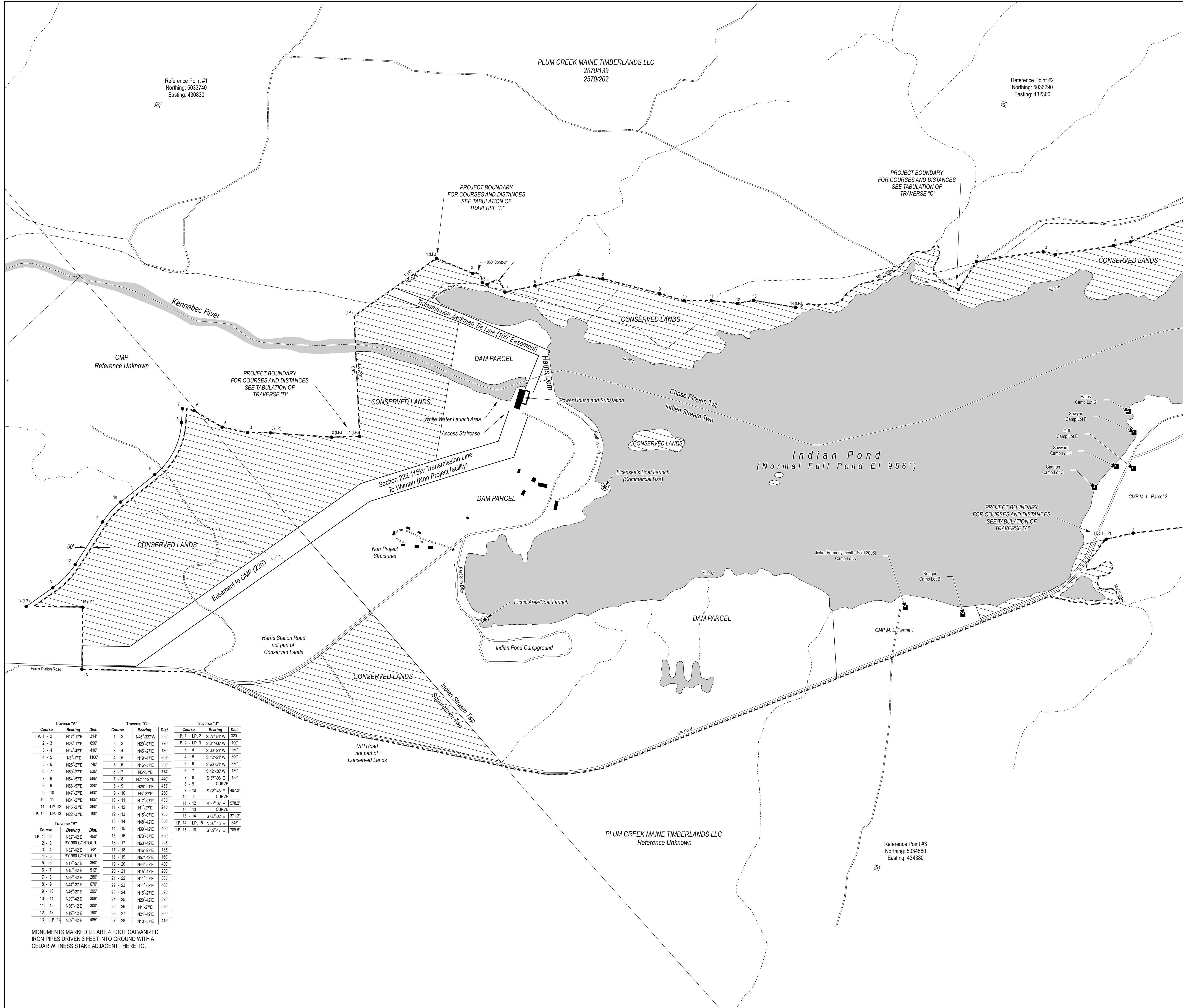

Legend

- Reference Point
- County Boundary
- Camp Lot
- Town Boundary
- Camp Site
- Stream
- Docking
- Private Access Road
- Boat Launch
- Private Access Road-Open to Public
- Project Boundary
- Proposed Western Mountain Charitable Foundation Trail
- Conserved Lands
- Flowage Rights (excluded from conservation easement)
- Hydrography

Reference Point Table
NAD83 UTM Zone 19N, Meters

Sheet #	Reference #	Northing	Easting
1	1	5033740.0	430830.0
1	2	5036290.0	432300.0
1	3	5034580.0	434380.0
2	4	5037620.0	432270.0
2	5	5040360.0	433700.0
2	6	5037570.0	435410.0
3	7	5041120.0	434680.0
3	8	5043350.0	435880.0
3	9	5041000.0	437770.0
4	10	5045090.0	435610.0
4	11	5047670.0	437040.0
4	12	5045890.0	439600.0
5	13	5042760.0	439030.0
5	14	5046030.0	439970.0
5	15	5044310.0	442350.0
6	16	5023860.0	398820.0
6	17	5026330.0	399570.0
6	18	5023690.0	401680.0
7	19	5030640.0	428820.0
7	20	5032740.0	430210.0
7	21	5031040.0	432700.0
8	22	5019390.0	421920.0
8	23	5021930.0	423450.0
8	24	5019350.0	425140.0

NOTES:

- PROJECT BOUNDARY IS TO BE THE 960' CONTOUR EXCEPT WHERE SPECIFICALLY NOTED AS OTHERWISE. 960' CONTOUR IS MARKED BY BLAZED TREES WITH THE BLAZE PAINTED YELLOW.
- VIP ROAD, ISLANDS WITHIN THE PROJECT BOUNDARY AND HARRIS DAM DIGITIZED FROM NADP (2009) ORTHOPHOTOGRAPHY COURTESY OF MAINE OFFICE OF GIS (MEGIS). INDIAN POND SHORELINE DIGITIZED FROM USGS 24K TOPOGRAPHIC MAP.
- AS USED ON THESE PLANS, CMP MEANS CENTRAL MAINE POWER COMPANY; FPL MEANS FPL ENERGY MAINE HYDRO LLC; FERC MEANS FEDERAL ENERGY REGULATORY COMMISSION.
- UNLESS OTHERWISE NOTED HEREON OR IN THE DEED, RAILROAD RIGHTS OF WAY, PUBLIC ROADS, BRIDGES, AND THIRD-PARTY UTILITIES ARE NOT PART OF THE FERC LICENSED PROJECT WORKS.
- CMP TRANSMISSION RIGHTS OF WAY ARE RETAINED IN EASEMENT WITHIN THE PROJECT BOUNDARIES.
- UNLESS OTHERWISE NOTED HEREON OR IN THE DEED, PROJECT LANDS INCLUDE ALL LANDS WITHIN THE PROJECT BOUNDARY, INCLUDING ISLANDS IN THE RIVER, THE RIVERBED AND THE POWERHOUSE PARCEL.
- CONTOURS AND ELEVATIONS ARE BASED UPON FEET ABOVE MEAN SEA LEVEL.
- HATCHED AREAS INDICATE CONSERVED LANDS. CONSERVED LANDS GENERALLY INCLUDE LANDS OWNED IN FEE BY LICENSEE UPSTREAM OF THE HARRIS DAM PARCEL BETWEEN USGS CONTOUR ELEVATION 956' AND THE INDIAN POND PROJECT BOUNDARY, EXCLUSIVE OF LEASED LANDS, AND LANDS OWNED IN FEE BY LICENSEE WITHIN THE PROJECT BOUNDARY DOWNSTREAM OF THE HARRIS DAM EXCLUSIVE OF THE DAM PARCEL AND RIVER BED, AS THOSE TERMS ARE DEFINED IN THE CONSERVATION EASEMENT TO THE STATE OF MAINE DEPARTMENT OF CONSERVATION, BUREAU OF PARKS & LANDS DATED JULY, 2011.
- CENTRAL MAINE POWER MASTER LEASE (CMP M.L.) PARCELS 1, 2, 3 & 4 REFERENCE A DEED DATED 04/08/1989 RECORDED IN THE SOMERSET COUNTY REGISTRY OF DEEDS, BOOK 2540, PAGE 24, ALSO RECORDED AT THE PISCATAQUIS COUNTY REGISTRY OF DEEDS, BOOK 1194, PAGE 188.
- THIS PLAN IS NOT A STANDARD BOUNDARY SURVEY. THE PURPOSE OF THIS PLAN IS TO ILLUSTRATE THE LOCATION OF THE PROJECT WORKS, PROJECT BOUNDARY AND CONSERVED LANDS.

STATE OF MAINE
JENNIFER A. PERRETT
REGISTERED PROFESSIONAL LAND SURVEYOR

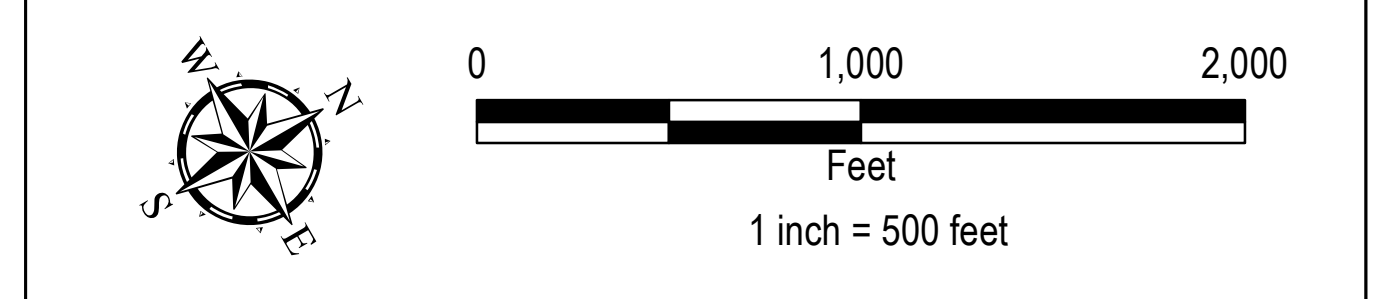

Exhibit G Project Detail Map
Harris Project **FERC NO. 2142**
FPL Energy Maine Hydro LLC

Date: Nov 04, 2011 Sheet 1 of 8 Prepared by: TRC

Traverse "A"			Traverse "C"			Traverse "D"		
Course	Bearing	Dist.	Course	Bearing	Dist.	Course	Bearing	Dist.
LP. 1 - 2	N17°17'E	314'	1 - 2	N46°33'W	385'	LP. 1 - LP. 2	S 27° 51' W	320'
2 - 3	N23°15'E	650'	2 - 3	N42°07'E	170'	LP. 2 - LP. 3	S 04° 36' W	700'
3 - 4	N14°42'E	410'	3 - 4	N42°27'E	130'	3 - 4	S 30° 21' W	200'
4 - 5	N3°17'E	1100'	4 - 5	N19°47'E	605'	4 - 5	S 42° 36' W	300'
5 - 6	N25°27'E	740'	5 - 6	N19°57'E	290'	5 - 6	S 60° 31' W	370'
6 - 7	N29°27'E	535'	6 - 7	N6°57'E	774'	6 - 7	S 42° 36' W	139'
7 - 8	N54°57'E	565'	7 - 8	N214°27'E	440'	7 - 8	S 57° 09' E	155'
8 - 9	N69°57'E	320'	8 - 9	N26°21'E	455'	8 - 9	CURVE	
9 - 10	N47°27'E	550'	9 - 10	N5°37'E	295'	9 - 10	S 08° 43' E	497.2'
10 - 11	N34°27'E	665'	10 - 11	N17°07'E	435'	10 - 11	CURVE	
11 - LP. 12	N15°27'E	360'	11 - 12	N1°27'E	245'	11 - 12	S 27° 07' E	578.2'
LP. 12 - LP. 13	N22°37'E	190'	12 - 13	CURVE		12 - 13	CURVE	
			12 - 13	N15°07'E	755'	13 - 14	S 09° 02' E	371.2'
			13 - 14	N45°42'E	350'	LP. 14 - LP. 15	N 30° 43' E	645'
			14 - 15	N39°42'E	460'	LP. 15 - 16	S 59° 17' E	709.9'
			15 - 16	N73°57'E	620'			
			16 - 17	N45°42'E	225'			
			17 - 18	N45°27'E	135'			
			18 - 19	N37°42'E	160'			
			19 - 20	N44°57'E	400'			
			20 - 21	N15°47'E	280'			
			21 - 22	N11°27'E	385'			
			22 - 23	N11°03'E	408'			
			23 - 24	N15°27'E	595'			
			24 - 25	N42°42'E	360'			
			25 - 26	N4°27'E	520'			
			26 - 27	N4°27'E	520'			
			27 - 28	N10°57'E	415'			

MONUMENTS MARKED I.P. ARE 4 FOOT GALVANIZED IRON PIPES DRIVEN 3 FEET INTO GROUND WITH A CEDAR WITNESS STAKE ADJACENT THERE TO.

Attachment VIII

From: [Goodwin, Mark](#)
To: [Beyer, Jim R](#); [Clement, Jay L NAE \(Jay.L.Clement@usace.army.mil\)](#); [Kirk-Lawlor, Naomi E](#); [Hinkel, Bill](#); [john.perry@maine.gov](#); ["mark.bergeron@maine.gov"](#)
Cc: [Mirabile, Gerry J. \(Gerry.Mirabile@cmpco.com\)](#); [Matt Manahan](#); [Johnston, Lauren A](#); [DEP, NECEC](#)
Subject: NECEC Construction Schedule Follow Up
Attachments: [image001.jpg](#)
[image002.jpg](#)
[image003.jpg](#)
[image004.jpg](#)
[image005.jpg](#)

Good morning:

As discussed in the meeting regarding the Kennebec River crossing and off-site mitigation held on May 31, 2018, please find the most recent construction schedule below.

Construction Activity	Estimated Start	Estimated Completion
Merrill Road HVDC Converter Construction	12/4/2019	4/5/2022
Larrabee Road Construction	8/21/2020	3/17/2022
Maine Yankee Construction	8/21/2020	6/24/2021
Raven Farm - Construction	7/10/2020	3/17/2022
Fickett Road - Construction	12/28/2020	4/6/2022
Coopers Mills Road - Construction	12/28/2020	8/18/2022
Surowiec - Construction	8/24/2020	3/24/2021
HVDC - Section 3006 Construction (Northern Section)	12/19/2019	7/31/2022
HVDC- Section 3006 Construction (Southern Section)	10/31/2019	7/31/2022
345kV - Section 3005 Construction	4/6/2022	6/27/2022
345 kV - Section 3027 Construction	5/12/2020	6/23/2021
115kV - Section 62 Construction	5/18/2021	12/30/2021
115kV - Section 64 Construction	5/12/2020	7/7/2021
*Changes in red, consistent with NECEC Program Schedule- UPDATE: 4/17/2018		

Please let me know if you have any questions.

Mark Goodwin, CPESC \ Burns & McDonnell

Senior Environmental Scientist

207-517-8482 \ Mobile 207-416-5707

magoodwin@burnsmcd.com \ burnsmcd.com

27 Pearl Street \ Portland, ME 04101



Proud to be one of *FORTUNE's* 100 Best Companies to Work For

Please consider the environment before printing this email.

This email and any attachments are solely for the use of the addressed recipients and may contain privileged client communication or privileged work product. If you are not the

intended recipient and receive this communication, please contact the sender by phone at 816-333-9400, and delete and purge this email from your email system and destroy any other electronic or printed copies. Thank you for your cooperation.